

MI988

**AMD Ryzen™ Embedded V1000
Mini-ITX Motherboard**

User's Manual

Version 1.0b
(Dec. 2018)

Copyright

© 2018 IBASE Technology, Inc. All rights reserved.

No part of this publication may be reproduced, copied, stored in a retrieval system, translated into any language or transmitted in any form or by any means, electronic, mechanical, photocopying, or otherwise, without the prior written consent of IBASE Technology, Inc. (hereinafter referred to as “IBASE”).

Disclaimer

IBASE reserves the right to make changes and improvements to the products described in this document without prior notice. Every effort has been made to ensure the information in the document is correct; however, IBASE does not guarantee this document is error-free.

IBASE assumes no liability for incidental or consequential damages arising from misapplication or inability to use the product or the information contained herein, nor for any infringements of rights of third parties, which may result from its use.

Trademarks

All the trademarks, registrations and brands mentioned herein are used for identification purposes only and may be trademarks and/or registered trademarks of their respective owners.

Compliance



This is a class B product. In a domestic environment, this product may cause radio interference in which case users may be required to take adequate measures.



This product has been tested and found to comply with the limits for a Class B device, pursuant to Part 15 of the FCC Rules. These limits are designed to provide reasonable protection against harmful interference in a residential installation. This equipment generates, uses and can radiate radio frequency energy and, if not installed and used in accordance with manufacturer's instructions, may cause harmful interference to radio communications.

WEEE



This product must not be disposed of as normal household waste, in accordance with the EU directive of for waste electrical and electronic equipment (WEEE - 2012/19/EU). Instead, it should be disposed of by returning it to a municipal recycling collection point. Check local regulations for disposal of electronic products.

Green IBASE



This product is compliant with the current RoHS restrictions and prohibits use of the following substances in concentrations exceeding 0.1% by weight (1000 ppm) except for cadmium, limited to 0.01% by weight (100 ppm).

- Lead (Pb)
- Mercury (Hg)
- Cadmium (Cd)
- Hexavalent chromium (Cr6+)
- Polybrominated biphenyls (PBB)
- Polybrominated diphenyl ether (PBDE)

Important Safety Information

Carefully read the precautions before using the board.

Environmental conditions:

- Use this product in environments with ambient temperatures between 0°C and 60°C.
- Do not leave this product in an environment where the storage temperature may be below -20° C or above 80° C. To prevent from damages, the product must be used in a controlled environment.

Care for your iBASE products:

- Before cleaning the PCB, unplug all cables and remove the battery.
- Clean the PCB with a circuit board cleaner, degreaser, or use cotton swabs and alcohol.
- Vacuum the dust with a computer vacuum cleaner to prevent the fan from being clogged.



WARNING

Attention during use:

- Do not use this product near water.
- Do not spill water or any other liquids on this product.
- Do not place heavy objects on the top of this product.

Anti-static precautions

- Wear an anti-static wrist strap to avoid electrostatic discharge.
- Place the PCB on an anti-static kit or mat.
- Hold the edges of PCB when handling.
- Touch the edges of non-metallic components of the product instead of the surface of the PCB.
- Ground yourself by touching a grounded conductor or a grounded bit of metal frequently to discharge any static.



CAUTION

Replace only with the same or equivalent type recommended by the manufacturer. Dispose of used batteries according to the manufacturer's instructions or recycle them at a local recycling facility or battery collection point.

Warranty Policy

- **IBASE standard products:**

24-month (2-year) warranty from the date of shipment. If the date of shipment cannot be ascertained, the product serial numbers can be used to determine the approximate shipping date.

- **3rd-party parts:**

12-month (1-year) warranty from delivery for the 3rd-party parts that are not manufactured by IBASE, such as CPU, CPU cooler, memory, storage devices, power adapter, panel and touchscreen.

- * PRODUCTS, HOWEVER, THAT FAIL DUE TO MISUSE, ACCIDENT, IMPROPER INSTALLATION OR UNAUTHORIZED REPAIR SHALL BE TREATED AS OUT OF WARRANTY AND CUSTOMERS SHALL BE BILLED FOR REPAIR AND SHIPPING CHARGES.

Technical Support & Services

1. Visit the IBASE website at www.ibase.com.tw to find the latest information about the product.
2. If you need any further assistance from your distributor or sales representative concerning problems that you may have encountered, please prepare the following information:
 - Product model name
 - Product serial number
 - Detailed description of the problem
 - The error messages in text or in screenshots if there is any
 - The arrangement of the peripherals
 - Software in use (such as OS and application software, including the version numbers)
3. If repair service is required, you can download the RMA form at <http://www.ibase.com.tw/english/Supports/RMAService/>. Fill out the form and contact your distributor or sales representative.

Table of Contents

Compliance	iii
Important Safety Information	iv
Warranty Policy	v
Technical Support & Services	v
Chapter 1 General Information	1
1.1 Introduction	2
1.2 Features	2
1.3 Packing List	3
1.4 Optional Accessories	3
1.5 Specifications	4
1.6 Block Diagram	6
1.7 Overview	7
1.8 Dimensions	9
Chapter 2 Hardware Configuration	11
2.1 Installations	12
2.1.1 Installing the Memory	12
2.2 Setting the Jumpers	13
2.2.1 How to Set Jumpers	13
2.3 Jumper & Connector Locations on MI988	14
2.4 Jumpers Quick Reference	15
2.4.1 LCD Panel Power Selection (JP2)	15
2.4.2 LCD Backlight Level (JP3)	16
2.4.3 PWM Backlight Control Level (JP4)	16
2.4.4 eDP Panel Power Selection (JP5)	17
2.4.5 eDP / LVDS Selection (JP6)	18
2.4.6 Clearing CMOS Data (JP7)	18
2.5 Connectors Quick Reference	19
2.5.1 eDP Connector (CN1)	20
2.5.2 COM3 & COM4 RS-232 Ports (CN6)	21
2.5.3 COM1 & COM2 RS-232/422/485 Ports (CN7)	22
2.5.4 DC-In Power Connector (J1)	23
2.5.5 LCD Backlight Connector (J8)	23

2.5.6	LVDS Connector (J6, J7)	24
2.5.7	SATA Power Connector (J11, J21)	25
2.5.8	Digital I/O Connector (J14).....	25
2.5.9	Front Panel Settings Connector (J13)	26
2.5.10	COM5 & COM6 RS-232 Port (J18, J16).....	27
2.5.11	Speaker Connector (J17).....	27
2.5.12	Audio Connector (J19).....	28
2.5.13	Fan Power Connectors (CPU_FAN1, SYS_FAN1, SYS_FAN2).....	29
Chapter 3 Drivers Installation		31
3.1	Introduction.....	32
3.2	AMD Ryzen™ V1000 Graphics Drivers.....	32
3.3	HD Audio Driver Installation	34
3.4	LAN Driver Installation	35
Chapter 4 BIOS Setup.....		37
4.1	Introduction.....	38
4.2	BIOS Setup.....	38
4.3	Main Settings.....	39
4.4	Advanced Settings.....	39
4.4.1	ACPI Settings	40
4.4.2	IDE Configuration	40
4.4.3	eDP/LVDS Configuration	41
4.4.4	iSmart Controller.....	41
4.4.5	NCT6116D Super IO Configuration.....	42
4.4.6	Hardware Monitor	44
4.4.7	CPU Configuration.....	44
4.4.8	AMI Graphic Output Protocol Policy	45
4.4.9	Network Stack Configuration.....	45
4.4.10	CSM Configuration	46
4.4.11	NVMe Configuration	46
4.4.12	USB Configuration	47
4.5	Chipset Settings.....	48
4.5.1	SB USB Configuration	48
4.6	Security Settings.....	49
4.7	Boot Settings	49
4.8	Save & Exit Settings	50
Appendix		51

iBASE

A.	I/O Port Address Map	52
B.	Interrupt Request Lines (IRQ).....	55
C.	Watchdog Timer Configuration	58
D.	Onboard Connector Types	63

Chapter 1

General Information

The information provided in this chapter includes:

- Features
- Packing List
- Specifications
- Block Diagram
- Board Overview
- Board Dimensions

1.1 Introduction

MI988 is a mini-ITX motherboard based on the AMD Ryzen™ V1000 APU. It offers high-definition visual experience and high performance on graphics processing. It can also be well utilized for designs of low power consumption in a board range of markets, including industrial control & automation, digital signage, thin client, electronic gaming machines, and SMB storage appliances.



1.2 Features

- AMD Ryzen™ Embedded V1000 on board
- 2 x DDR4 SO-DIMM expandable up to 32 GB, ECC supported
- 2 x PCIe GbE LAN
- 1 x HDMI (2.0a), 1x DisplayPort (1.4), 1x 24-bit dual channel LVDS, 1 x eDP
- 4 x USB3.1, 1 x SATA III, 6 x COM
- 1 x PCIe (x8), 1x Mini-PCIe socket, 1 x M.2 M2230

1.3 Packing List

Your product package should include the items listed below. If any of the items below is missing, contact the distributor or dealer from whom you purchased the product.

- MI988 Motherboard
- I/O Shield
- SATA Cable (SATA-26C)
- Power Cable (PW129)
- Disk (including chipset drivers)
- This User's Manual

1.4 Optional Accessories

IBASE provides optional accessories as follows. Please contact us or your dealer if you need any.

- Power Adaptor (150W)
- COM Port Cable (PK1H)
- USB Cable (USB2K-9)
- Audio Cable (Audio-34)

1.5 Specifications

Product Name	MI988
Form Factor	Mini-ITX motherboard
System	
Operating System	<ul style="list-style-type: none"> • Windows 10 (64-bit) • Linux
CPU & Chipset	AMD Ryzen™ Embedded V1000 APU onboard
Memory	2 x DDR4-2666 SO-DIMM, expandable up to 32 GB, ECC compatible
Storage	SSD via M.2 slot
Graphics	AMD Vega GPU integrated
Network	2 x LAN: Intel® I211AT PCIe GbE
Super I/O	Nuvoton NCT6116D
Audio Codec	Built in HD audio with Realtek ALC662 for 5.1 channel
Power Requirement	DC-In 12 ~ 24V
Watchdog Timer	Yes (256 segments, 0, 1, 2...255 sec / min)
BIOS	AMI BIOS
EuP / ErP	Yes
Dimensions	170 x 170 mm (6.7" x 6.7")
RoHS	Yes
Certification	CE, FCC Class B, LVD
I/O Ports	
Display	<ul style="list-style-type: none"> • 1 x HDMI 2.0a (3840 x 2160 at 60 Hz) • 1 x DisplayPort 1.4 (3840 x 2160 at 60 Hz) • 1 x 24-bit dual channel LVDS (1920 x 1080 at 60 Hz) or eDP (1920 x 1080 at 60 Hz)
LAN	2 x RJ45 GbE LAN
USB	4 x USB 3.1

Serial	<p>6 x COM ports:</p> <ul style="list-style-type: none"> • COM1 & COM2: RS-232/422/485 (edge I/O connectors, jumper-less selection) • COM3 ~ COM4: RS-232 only (edge I/O connectors) • COM5 ~ COM6: RS-232 only (via on-board box-headers)
SATA	<p>2 x SATA 3.0</p> <p>* Use either the SATA 3.0 port (connector SATA1) or the M.2 Slot.</p>
Audio Jack	1 x Line-In, 1 x Line-Out, 1 x Mic-In
Digital IO	4-In & 4-Out
Expansion Slots	<ul style="list-style-type: none"> • 1 x PCIe (x8) slot • 1 x half-size Mini-PCIe slot with USB & PCIe • 1 x M.2 M2280 slot for SSD <p>* Use either the SATA 3.0 port (connector SATA1) or the M.2 Slot.</p>
Environment	
Temperature	<ul style="list-style-type: none"> • Operating: 0 ~ 60 °C (32 ~ 140 °F) • Storage: -20 ~ 80 °C (-4 ~ 176 °F)
Relative Humidity	0 ~ 90 %, non-condensing at 60 °C

All specifications are subject to change without prior notice.

1.6 Block Diagram

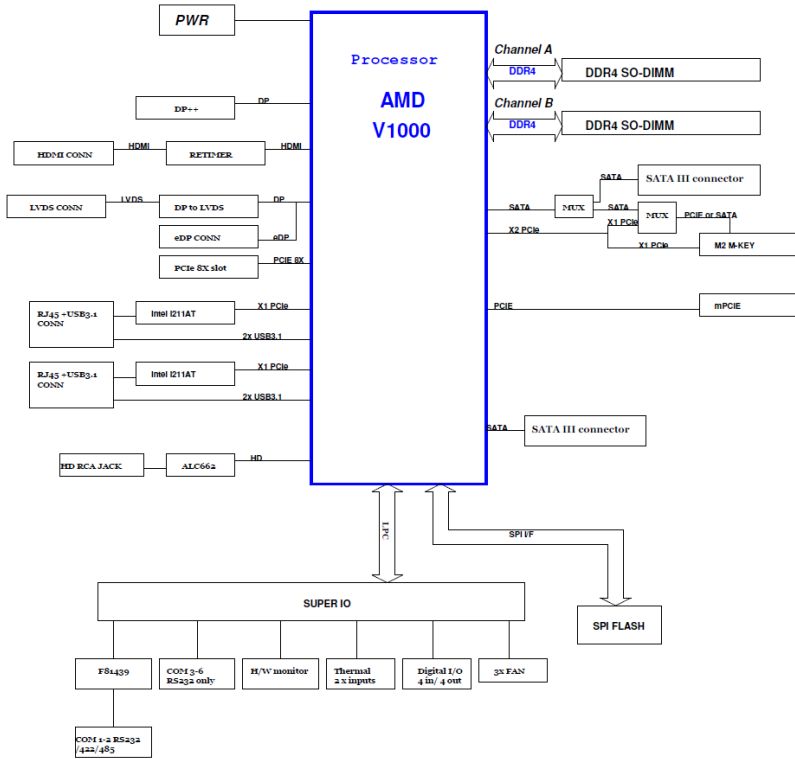

1.7 Overview

Top View

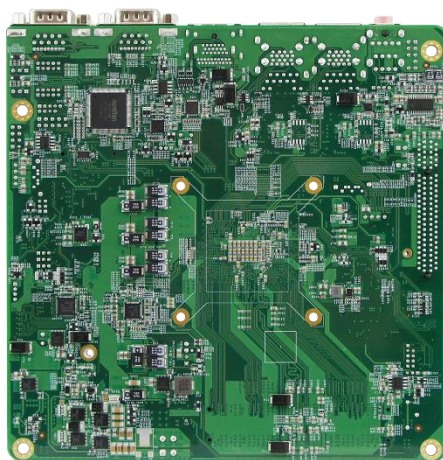

* The photos above are for reference only. Some minor components may differ.

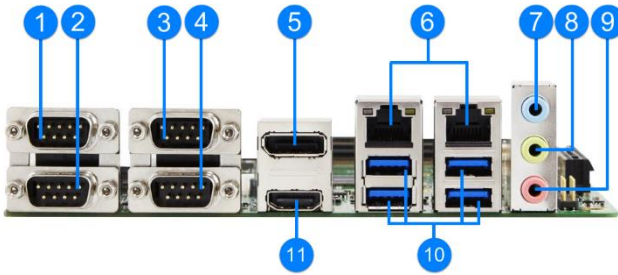

No.	Name	No.	Name
1	COM3 Port	7	Audio Line-In
2	COM4 Port	8	Audio Line-Out
3	COM1 Port	9	Microphone-In
4	COM2 Port	10	USB 3.1 Ports
5	DisplayPort	11	HDMI Port
6	GbE LAN Ports		

1.8 Dimensions

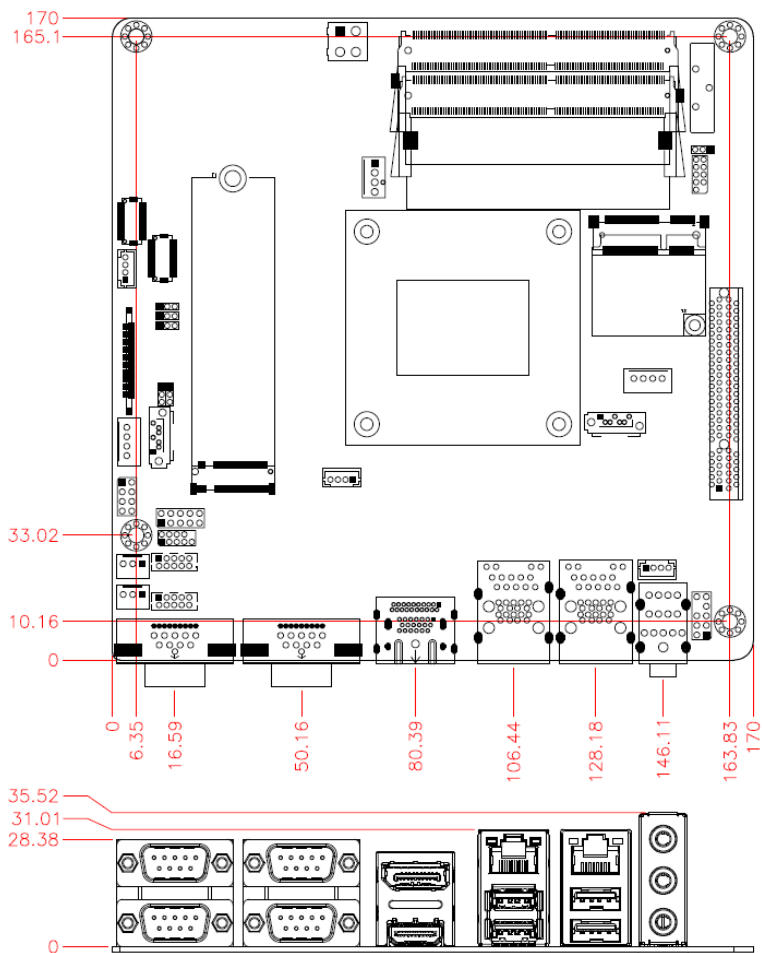

This page is intentionally left blank.

Chapter 2

Hardware Configuration

This section provides information on jumper settings and connectors on the board in order to set up a workable system. On top of that, you will also need to install crucial pieces such as the CPU and the memory before using the product. The topics covered are:

- Installations: CPU and the memory
- Jumper and connector locations
- Jumper settings and information of connectors

2.1 Installations

2.1.1 Installing the Memory

To install the modules, locate the memory slot on the board and perform the following steps:

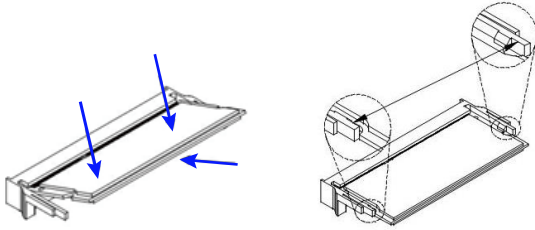

1. Align the key of the memory module with that on the memory slot and insert the module slantwise.
2. Gently push the module in an upright position until the clips of the slot close to hold the module in place when the module touches the bottom of the slot.

To remove the module, press the clips outwards with both hands, and the module will pop-up.

2.2 Setting the Jumpers

Set up and configure your board by using jumpers for various settings and features according to your needs and applications. Contact your supplier if you have doubts about the best configuration for your use.

2.2.1 How to Set Jumpers

Jumpers are short-length conductors consisting of several metal pins with a non-conductive base mounted on the circuit board. Jumper caps are used to have the functions and features enabled or disabled. If a jumper has 3 pins, you can connect either PIN1 to PIN2 or PIN2 to PIN3 by shorting.

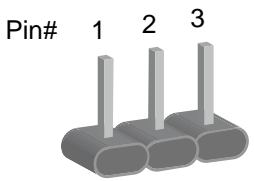

A 3-pin jumper

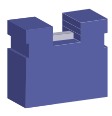

A jumper cap

Refer to the illustration below to set jumpers.

Pin closed	Oblique view	Illustration
Open		
1-2		
2-3		

When two pins of a jumper are encased in a jumper cap, this jumper is **closed**, i.e. turned **On**.

When a jumper cap is removed from two jumper pins, this jumper is **open**, i.e. turned **Off**.

2.3 Jumper & Connector Locations on MI988

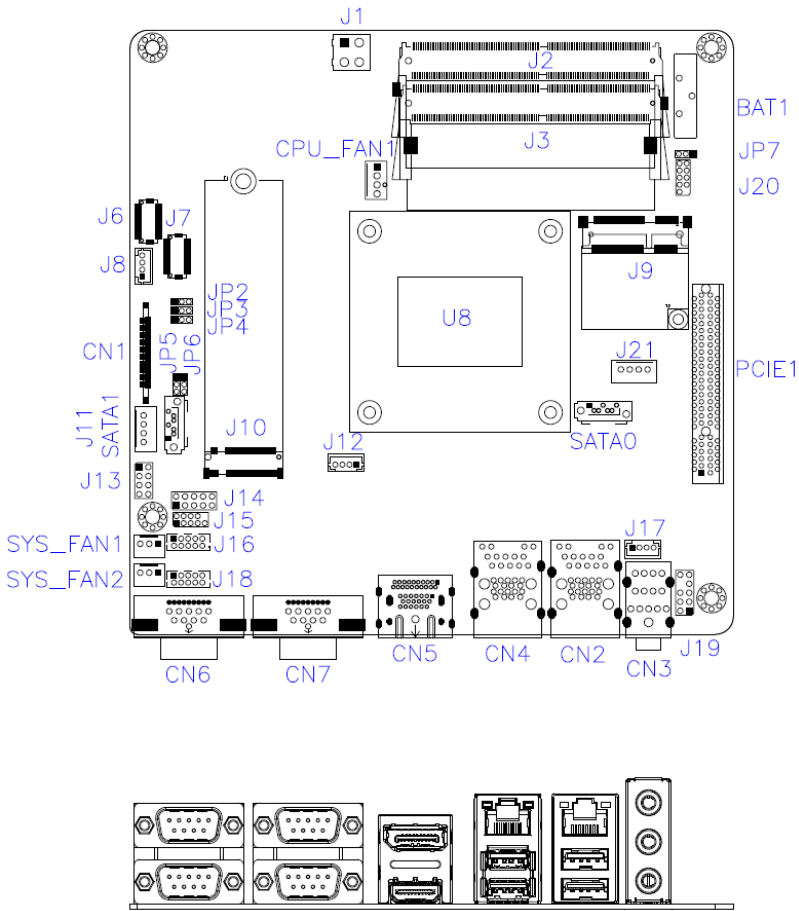

2.4 Jumpers Quick Reference

Function	Jumper Name	Page
LCD Panel Power Selection	JP2	15
LCD Backlight Level	JP3	16
PWM Backlight Control Level	JP4	16
eDP Panel Power Selection	JP5	17
eDP / LVDS Selection	JP6	18
Clearing CMOS Data	JP7	18

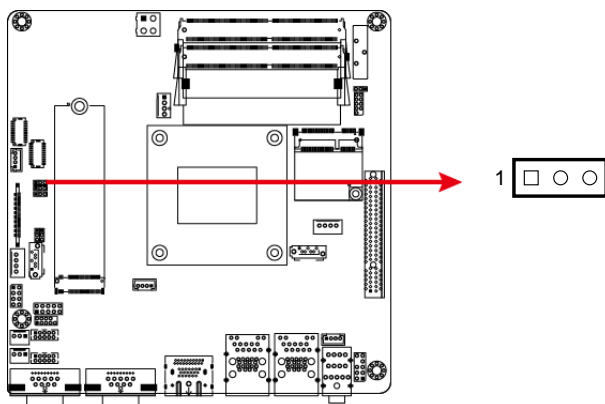

2.4.1 LCD Panel Power Selection (JP2)



Function	Pin closed	Illustration
3.3V (default)	1-2	1
5V	2-3	1

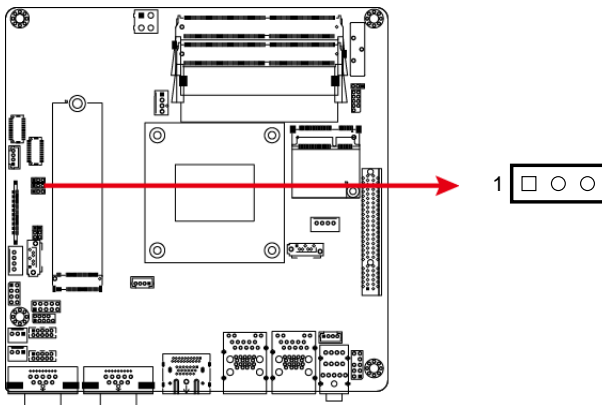

2.4.2 LCD Backlight Level (JP3)

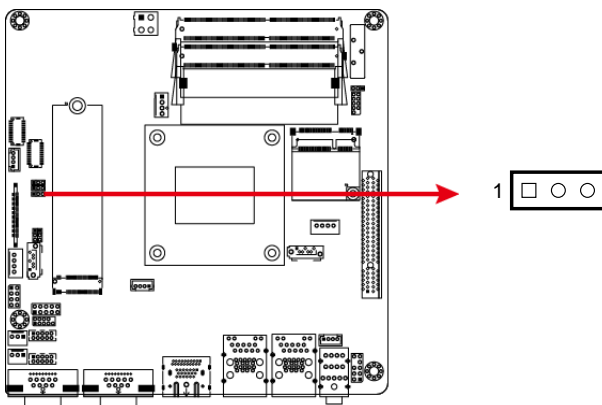

Function	Pin closed	Illustration
3.3V (default)	1-2	1 
5V	2-3	1 

2.4.3 PWM Backlight Control Level (JP4)



Function	Pin closed	Illustration
3.3V (default)	1-2	1 
5V	2-3	1 

2.4.4 eDP Panel Power Selection (JP5)

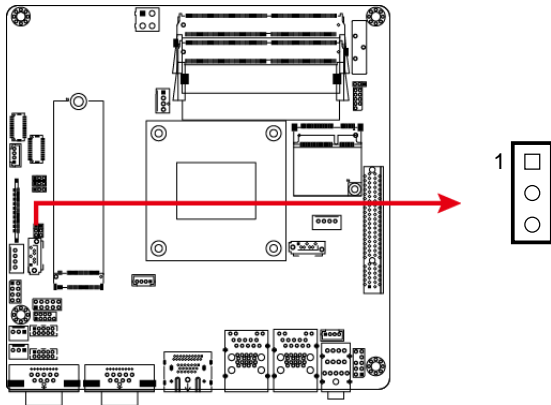

Function	Pin closed	Illustration
3.3V (default)	1-2	1
5V	2-3	1

2.4.5 eDP / LVDS Selection (JP6)

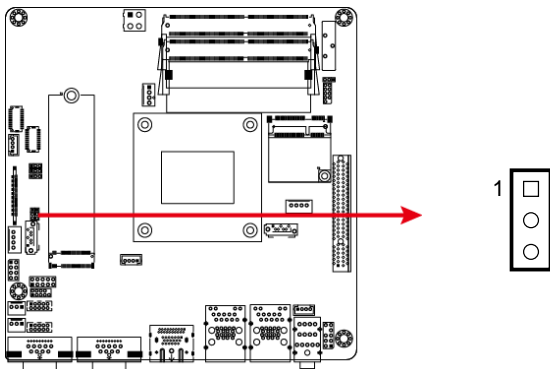

Function	Pin closed	Illustration
Auto Detection (default)	1-2	
LVDS Only	2-3	

2.4.6 Clearing CMOS Data (JP7)

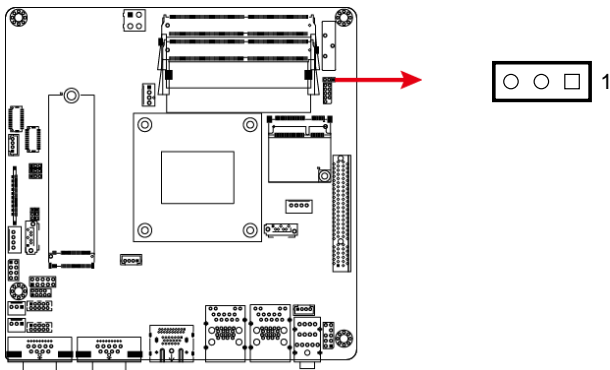

Function	Pin closed	Illustration
Normal (default)	1-2	
Clear CMOS	2-3	

2.5 Connectors Quick Reference

Function	Connector Name	Page
eDP Connector	CN1	20
COM3 & COM4 RS-232 Ports	CN6	21
COM1 & COM2 RS-232/422/485 Ports	CN7	22
DC-In Power Connector	J1	23
LCD Backlight Connector	J8	23
LVDS Connector	J6 (Channel A), J7 (Channel B)	24
SATA Power Connector	J11, J21	25
Digital I/O Connector	J14	25
Front Panel Settings Connector	J13	26
COM5 & COM6 RS-232 Port	J18 (COM5), J16 (COM6)	27
Speaker Connector	J17	27
Audio Connector	J19	28
Fan Power Connectors	CPU_FAN1, SYS_FAN1, SYS_FAN2	29
GbE LAN Port and Dual USB 3.1 Ports	CN2, CN4	--
DisplayPort & HDMI Port	CN5	--
DDR4 SO-DIMM Slot	J2, J3	--
Mini-PCIe Slot	J9	--
M.2 M2280 Slot	J10	--
SATA III Connector	SATA0, SATA1	--
PCIe (x8) Slot	PCIE1	--
RTC Lithium Button Cell Holder	BAT1	--
Factory Use Only	J12, J15, J20	--

2.5.1 eDP Connector (CN1)

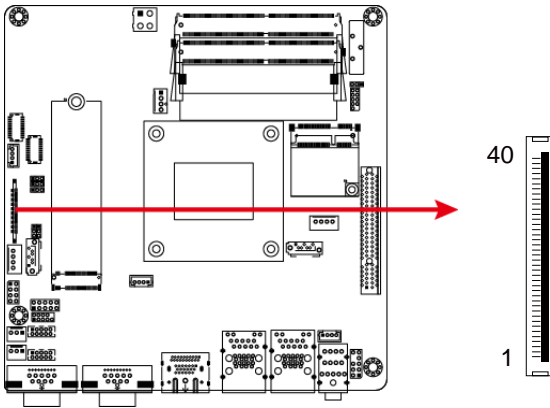

Pin	Signal Name	Pin	Signal Name
1	+3.3V (default) / +5V	21	TXN0
2	+3.3V (default) / +5V	22	TXP0
3	+3.3V (default) / +5V	23	Ground
4	+3.3V (default) / +5V	24	AUXP
5	+3.3V (default) / +5V	25	AUXN
6	Ground	26	NC
7	Ground	27	VCC3
8	Ground	28	VCC12
9	Ground	29	NC
10	HOT PLUG	30	Ground
11	Ground	31	VCC5
12	NC	32	NC
13	NC	33	Brightness
14	Ground	34	BKLT_EN
15	NC	35	VCC12
16	NC	36	VCC3
17	Ground	37	Ground
18	TXN1	38	SMB_CLK
19	TXP1	39	SMB_DATA
20	Ground	40	NC

2.5.2 COM3 & COM4 RS-232 Ports (CN6)

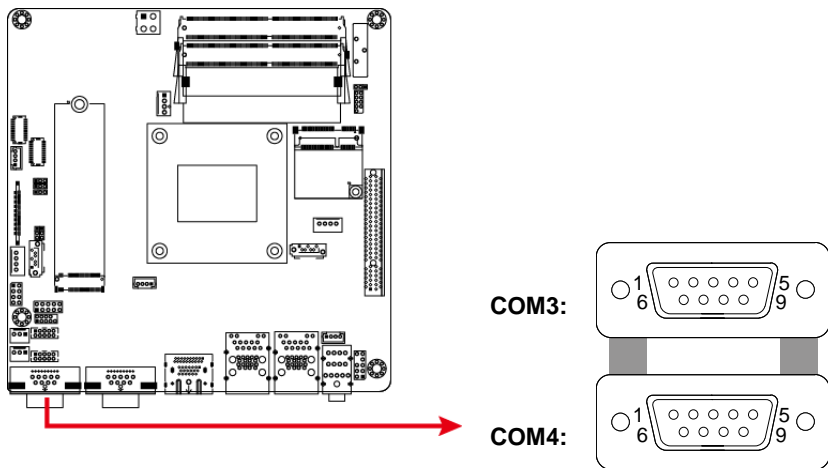

Pin	Signal Name	Pin	Signal Name
1	DCD, Data carrier detect	6	DSR, Data set ready
2	RXD, Receive data	7	RTS, Request to send
3	TXD, Transmit data	8	CTS, Clear to send
4	DTR, Data terminal ready	9	RI, Ring indicator
5	Ground		

2.5.3 COM1 & COM2 RS-232/422/485 Ports (CN7)

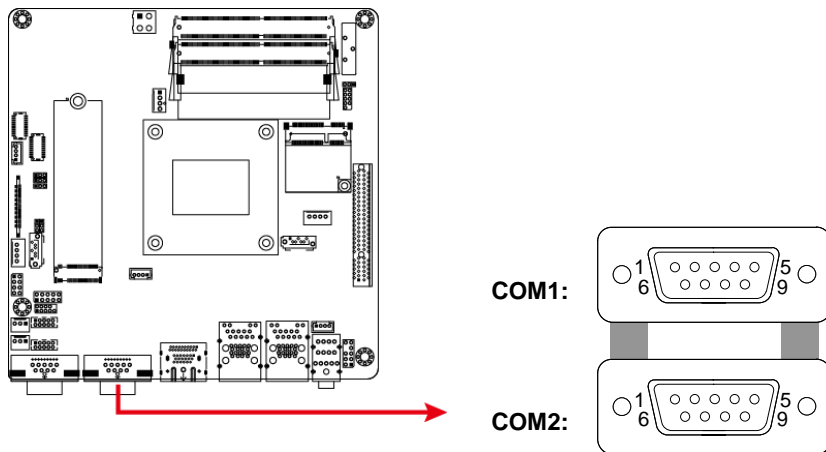

COM1 and **COM2** RS-232/422/485 ports are jumper-less and configurable in BIOS.

Pin	Signal Name	Pin	Signal Name
1	DCD, Data carrier detect	6	DSR, Data set ready
2	RXD, Receive data	7	RTS, Request to send
3	TXD, Transmit data	8	CTS, Clear to send
4	DTR, Data terminal ready	9	RI, Ring indicator
5	Ground		

Pin	Signal Name		
	RS-232	RS-422	RS-485
1	DCD	TX-	Data-
2	RXD	TX+	Data+
3	TXD	RX+	NC
4	DTR	RX-	NC
5	Ground	Ground	Ground
6	DSR	NC	NC
7	RTS	NC	NC
8	CTS	NC	NC
9	RI	NC	NC

2.5.4 DC-In Power Connector (J1)

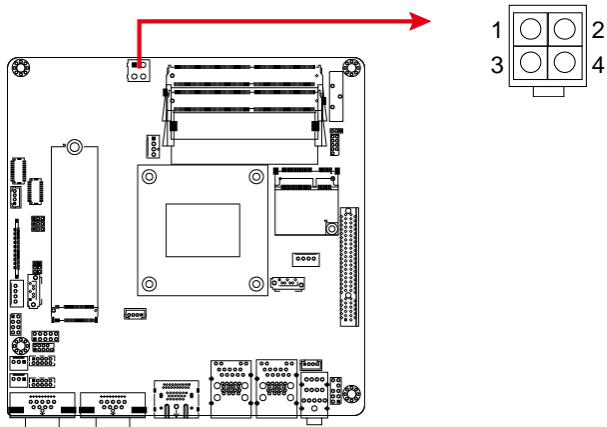

Pin	Signal Name	Pin	Signal Name
1	Ground	2	Ground
3	+12 ~ +24V	4	+12 ~ +24V

2.5.5 LCD Backlight Connector (J8)

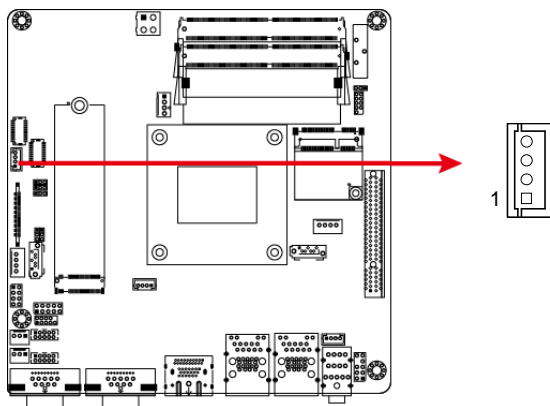

Pin	Signal Name	Pin	Signal Name
1	+12V	3	Brightness Control
2	Backlight Enable	4	Ground

2.5.6 LVDS Connector (J6, J7)

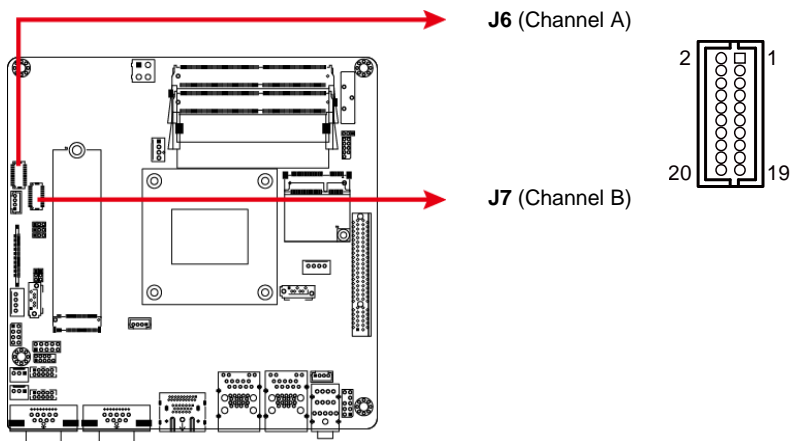

Pin	Signal Name	Pin	Signal Name
1	TX0+	2	TX0-
3	Ground	4	Ground
5	TX1+	6	TX1-
7	Ground	8	Ground
9	TX2+	10	TX2-
11	Ground	12	Ground
13	TXC+	14	TXC-
15	Ground	16	Ground
17	TX3+	18	TX3-
19	+3.3 / +5V	20	+3.3 / +5V

2.5.7 SATA Power Connector (J11, J21)

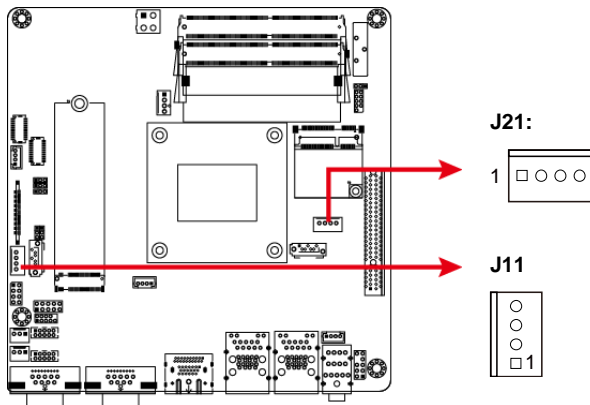

Pin	Signal Name	Pin	Signal Name
1	+5V	3	Ground
2	Ground	4	+12V

2.5.8 Digital I/O Connector (J14)

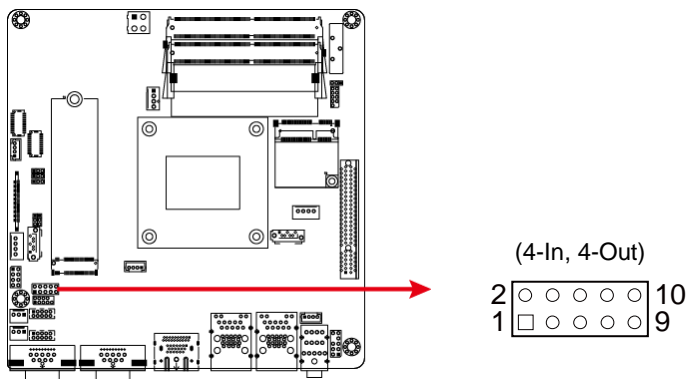

Pin	Signal Name	Pin	Signal Name
1	Ground	2	+5V
3	OUT3	4	OUT1
5	OUT2	6	OUT0
7	IN3	8	IN1
9	IN2	10	IN0

2.5.9 Front Panel Settings Connector (J13)

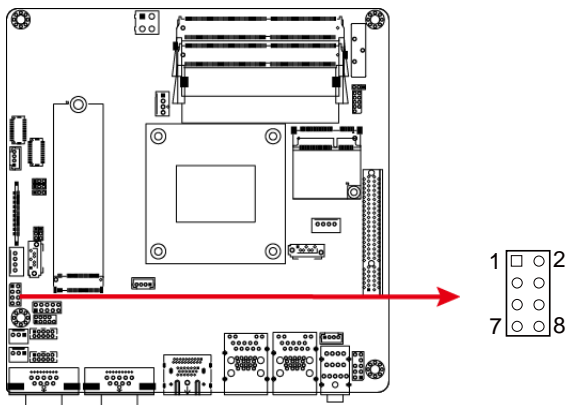

Pin	Signal Name	Pin	Signal Name
1	Power BTN-	2	Power BTN+
3	HDD LED+	4	HDD LED-
5	Reset BTN-	6	Reset BTN+
7	Power LED+	8	Power LED-

J13 is utilized for system indicators to provide light indication of the computer activities and switches to change the computer status. It provides interfaces for the following functions.

- **ATX Power ON Switch (Pins 1 and 2)**

The 2 pins make an “ATX Power Supply On/Off Switch” for the system that connects to the power switch on the case. When pressed, the power switch will force the system to power on. When pressed again, it will power off the system.

- **Hard Disk Drive LED Connector (Pins 3 and 4)**

This connector connects to the hard drive activity LED on control panel. This LED will flash when the HDD is being accessed.

- **Reset Switch (Pins 5 and 6)**

The reset switch allows you to reset the system without turning the main power switch off and then on again. Orientation is not required when making a connection to this header.

- **Power LED (Pins 7 and 8)**

This connector connects to the system power LED on control panel. This LED will light when the system turns on.

2.5.10 COM5 & COM6 RS-232 Port (J18, J16)

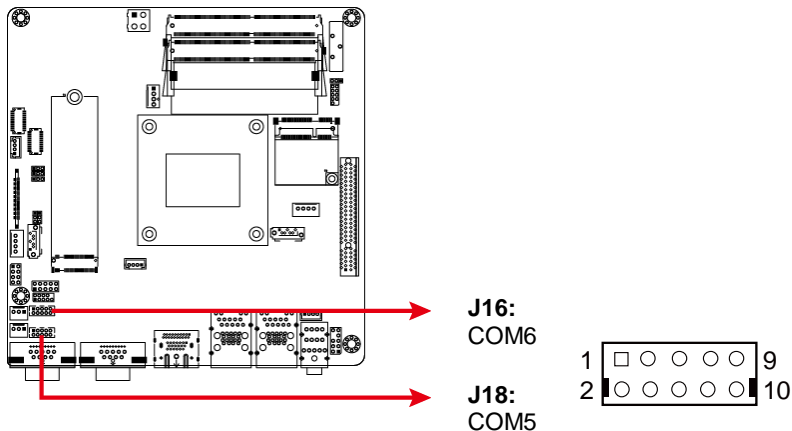

Pin	Signal Name	Pin	Signal Name
1	DCD, Data carrier detect	2	RXD, Receive data
3	TXD, Transmit data	4	DTR, Data terminal ready
5	Ground	6	DSR, Data set ready
7	RTS, Request to send	8	CTS, Clear to send
9	RI, Ring indicator	10	Key

2.5.11 Speaker Connector (J17)

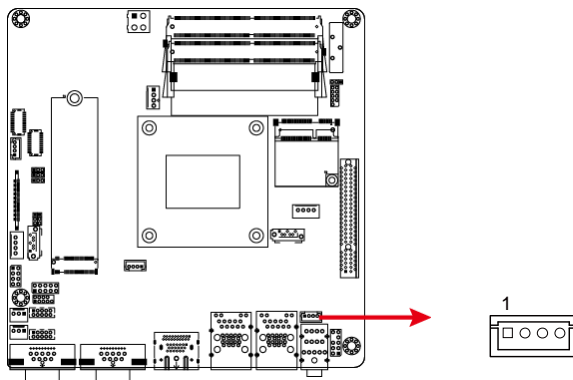

Pin	Signal Name	Pin	Signal Name
1	Speaker-R+	3	Speaker-L-
2	Speaker-R-	4	Speaker-L+

2.5.12 Audio Connector (J19)

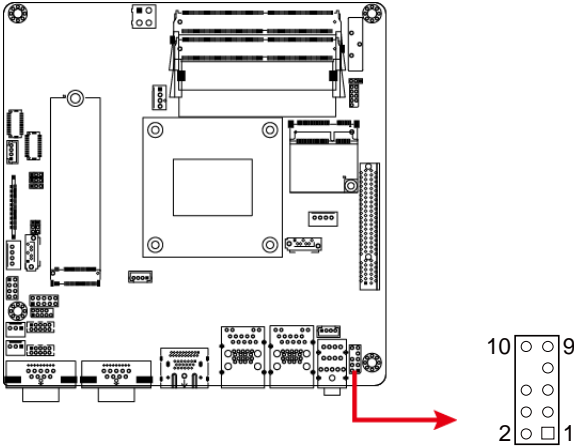

Pin	Signal Name	Pin	Signal Name
1	MIC IN_L	2	Ground
3	MIC IN_R	4	AUD_DETECT
5	LINE_IN_R	6	JD_MIC_IN
7	Sense	8	KEY
9	LINE_IN_L	10	JD_LINE_IN

2.5.13 Fan Power Connectors (CPU_FAN1, SYS_FAN1, SYS_FAN2)

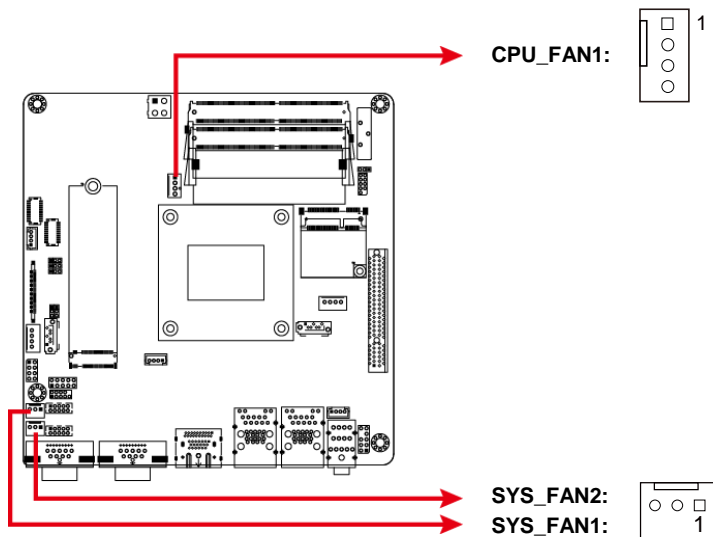

CPU_FAN1: CPU fan power connector

Pin	Signal Name	Pin	Signal Name
1	Ground	3	Rotation detection
2	+12V	4	Control

SYS_FAN1 & SYS_FAN2: System fan power connectors

Pin	Signal Name	Pin	Signal Name
1	Ground	3	Rotation detection
2	+12V		

This page is intentionally left blank.

Chapter 3

Drivers Installation

This chapter introduces installation of the following drivers:

- AMD Ryzen™ V1000 Graphics Driver
- HD Audio Driver
- LAN Driver

3.1 Introduction

This section describes the installation procedures for software and drivers. The software and drivers are included with the motherboard. If you find anything missing, please contact the distributor where you made the purchase. The contents of this section include the following:

3.2 AMD Ryzen™ V1000 Graphics Drivers

1. Insert the disk enclosed in the package with the board. Click **AMD** on the left pane and then **AMD Ryzen V1000 Drivers** on the right pane.

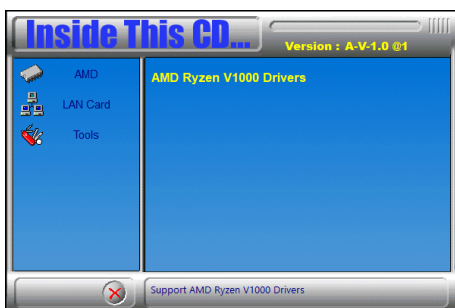

2. Click **AMD Ryzen V1000 Graphics Drivers**.

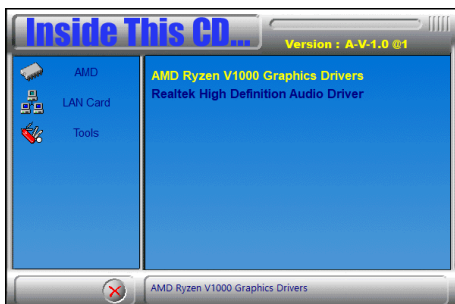

3. Read the software license agreement and click Accept and Install to proceed.

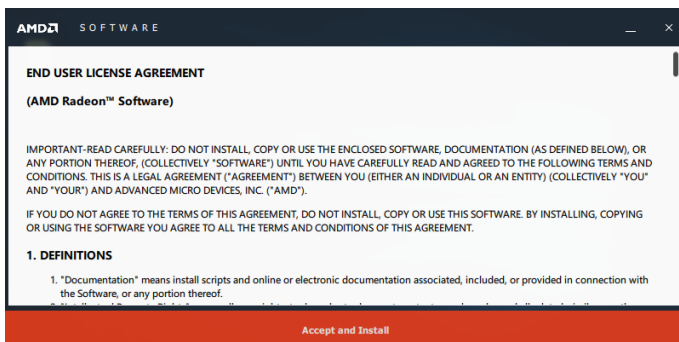

4. Choose and click on either **Express Install** or **Custom Install**.

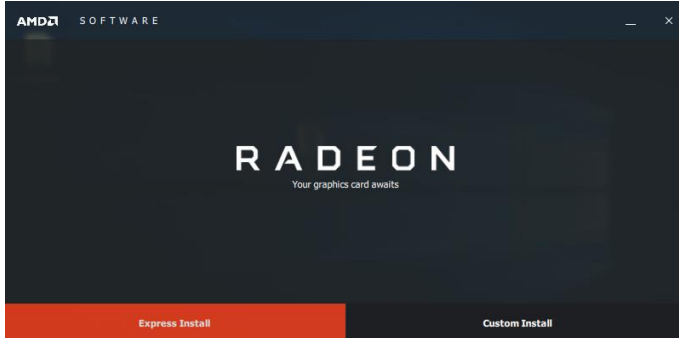

5. Click Install.

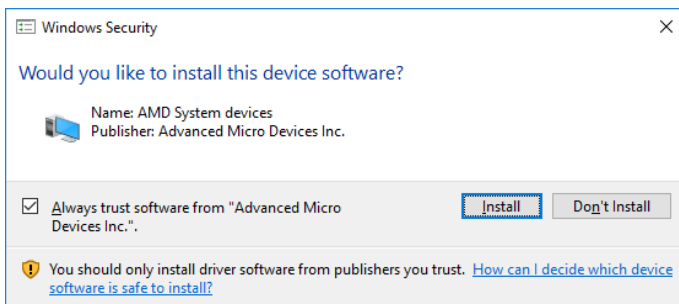

6. The driver has been completely installed. Restart the computer for changes to take effect.

3.3 HD Audio Driver Installation

1. Click **AMD** on the left pane and then **AMD Ryzen V1000 Drivers** on the right pane.

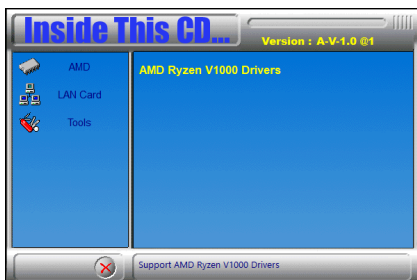

2. Click **Realtek High Definition Audio Driver**.

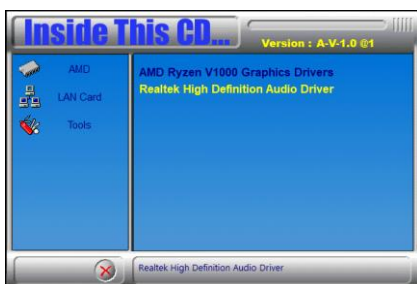

3. On the *Welcome* screen of the InstallShield Wizard, click **Next**.

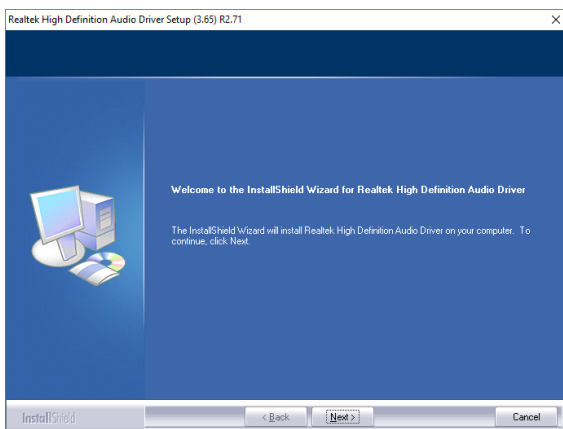

4. Click **Next** until the installation starts.
5. The driver has been completely installed. Restart the computer for changes to take effect.

3.4 LAN Driver Installation

1. Click **LAN Card** on the left pane and then **Intel LAN Controller Drivers** on the right pane.

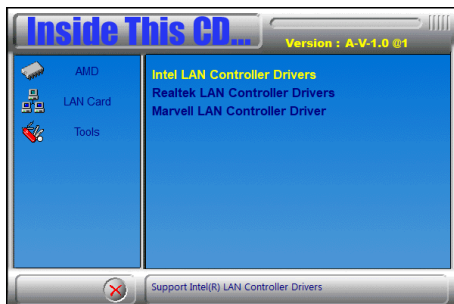

2. Click **Intel(R) I21x Gigabit Networks Drivers**.

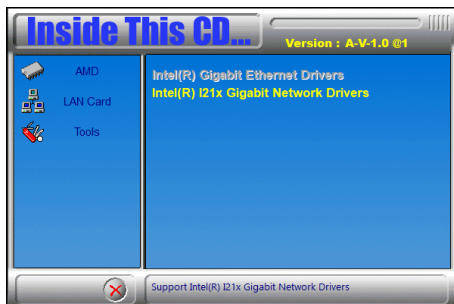

3. When the *Welcome* screen appears, click **Next**.

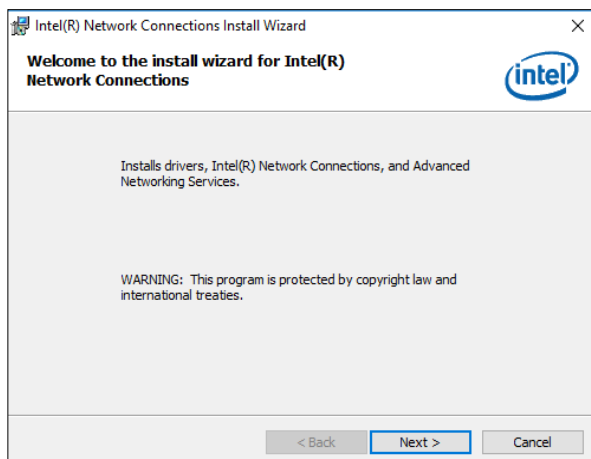

4. Accept the license agreement and click **Next**.

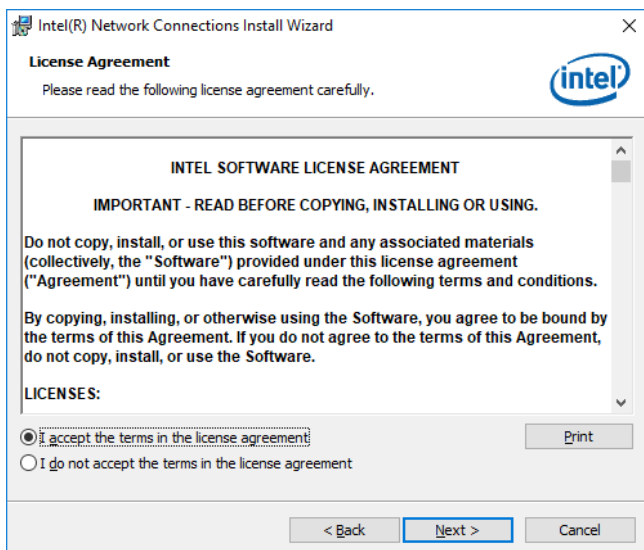

5. On the *Setup Options* screen, tick the checkbox to select the desired driver(s) for installation. Then click **Next** to continue.

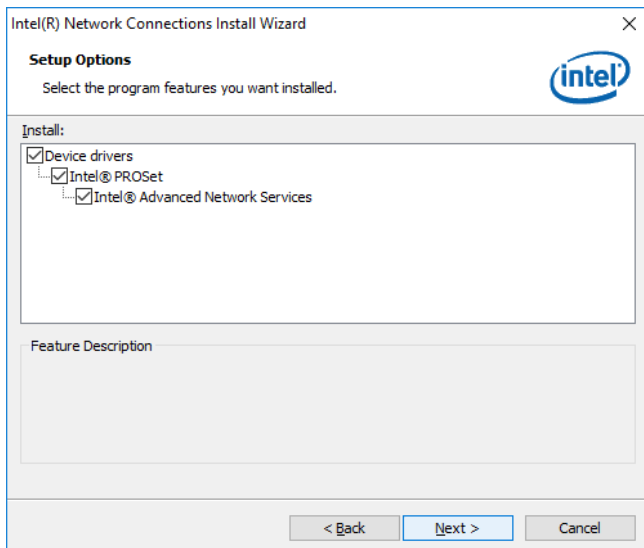

6. The wizard is ready for installation. Click **Install**.
7. As the installation is complete, restart the computer for changes to take effect.

Chapter 4

BIOS Setup

This chapter describes the different settings available in the AMI BIOS that comes with the board. The topics covered in this chapter are as follows:

- Main Settings
- Advanced Settings
- Chipset Settings
- Boot Settings
- Security Settings
- Save & Exit

4.1 Introduction

The BIOS (Basic Input/Output System) installed in the ROM of your computer system supports AMD APU. The BIOS provides critical low-level support for standard devices such as disk drives, serial ports and parallel ports. It also provides password protection as well as special support for detailed fine-tuning of the chipset controlling the entire system.

4.2 BIOS Setup

The BIOS provides a Setup utility program for specifying the system configurations and settings. The BIOS ROM of the system stores the Setup utility. When you turn on the computer, the BIOS is immediately activated. Press the key immediately allows you to enter the Setup utility. If you are a little bit late pressing the key, POST (Power On Self Test) will continue with its test routines, thus preventing you from invoking the Setup.

If you still need to enter Setup, restart the system by pressing the "Reset" button or simultaneously pressing the <Ctrl>, <Alt> and <Delete> keys. You can also restart by turning the system Off and back On again.

The following message will appear on the screen:

```
Press <DEL> to Enter Setup
```

In general, press the arrow keys to highlight items, <Enter> to select, the <PgUp> and <PgDn> keys to change entries, <F1> for help, and <Esc> to quit.

When you enter the BIOS Setup utility, the *Main Menu* screen will appear on the screen. The Main Menu allows you to select from various setup functions and exit choices.

Warning: It is strongly recommended that you avoid making any changes to the chipset defaults.

These defaults have been carefully chosen by both AMI and your system manufacturer to provide the absolute maximum performance and reliability. Changing the defaults could make the system unstable and crash in some cases.

4.3 Main Settings

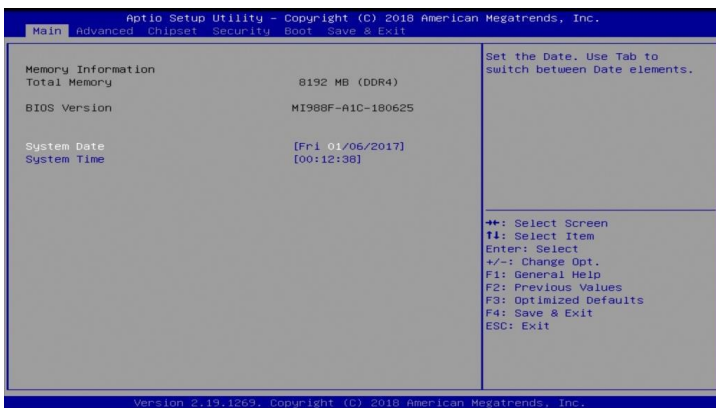

BIOS Setting	Description
System Date	Sets the date. Use the <Tab> key to switch between the data elements.
System Time	Set the time. Use the <Tab> key to switch between the data elements.

4.4 Advanced Settings

This section allows you to configure, improve your system and allows you to set up some system features according to your preference.

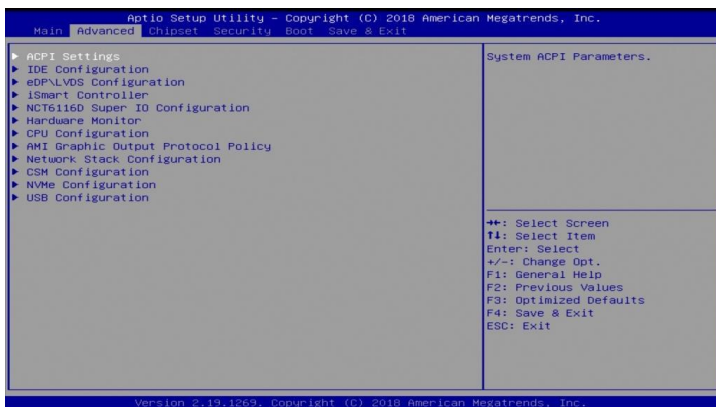

4.4.1 ACPI Settings

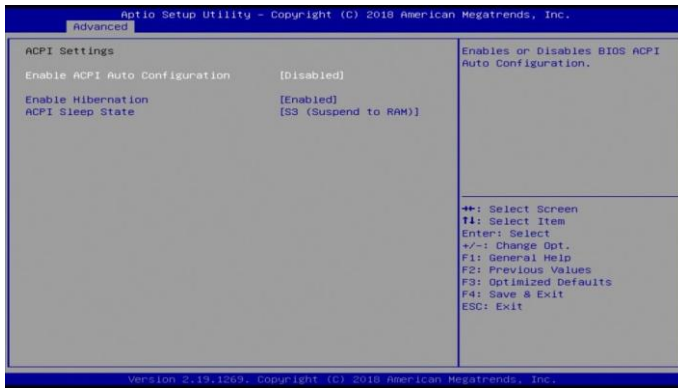

BIOS Setting	Description
Enable ACPI Auto Configuration	Enables / Disables BIOS ACPI auto configuration.
Enable Hibernation	Enables / Disables the system ability to hibernate (OS/S4 Sleep State). This option may be not effective with some OS.
ACPI Sleep State	Selects an ACPI sleep state where the system will enter when the Suspend button is pressed.

4.4.2 IDE Configuration

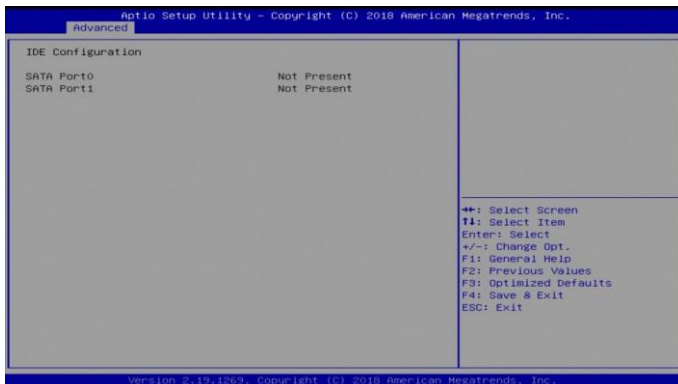

BIOS Setting	Description
SATA Ports	Detects the connection of SATA0 and SATA1.

4.4.3 eDP/LVDS Configuration



BIOS Setting	Description
eDP / LVDS Control	Enables / Disables the eDP or LVDS function.

4.4.4 iSmart Controller

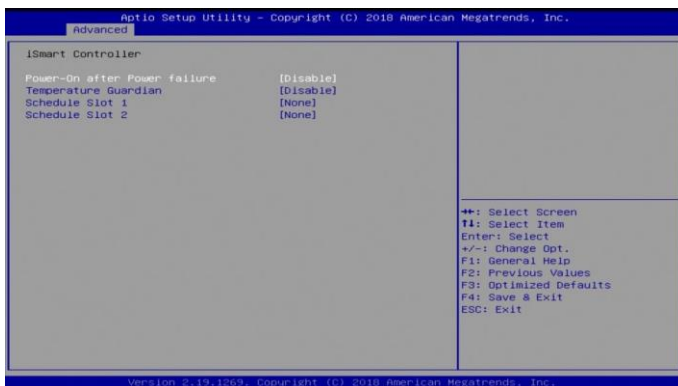

BIOS Setting	Description
Power-On after Power failure	Enables / Disables the system to be turned on automatically after a power failure.
Temperature Guardian	Generate the reset signal when system hands up on POST.

BIOS Setting	Description
Schedule Slots	<p>Sets up the hour / minute / day for the power-on schedule for the system.</p> <p>Options:</p> <ul style="list-style-type: none"> • None • Power On • Power On / Off <p>Important: If you would like to set up a schedule between adjacent days, configure two schedule slots.</p> <p>For example, if setting up a schedule from Wednesday 5 p.m. to Thursday 2 a.m., configure two schedule slots. But if setting up a schedule from 3 p.m to 5 p.m. on Wednesday, configure only a schedule slot.</p>

4.4.5 NCT6116D Super IO Configuration

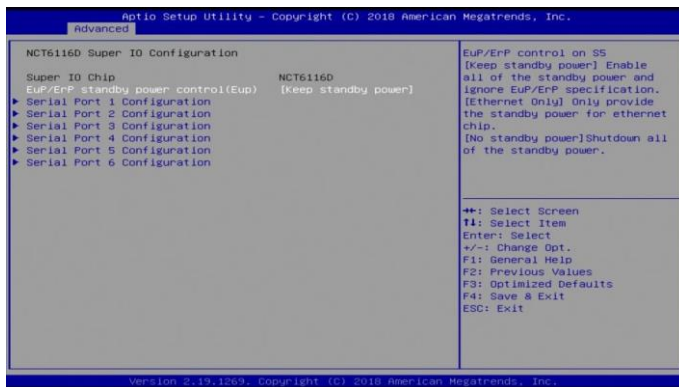

BIOS Setting	Description
Eup / ErP Standby Power Control (EuP)	<p>Eup/Erp Control on S5. Options are as below.</p> <p>Keep standby power: Enables all of the standby power and ignore Eup/ErP specification.</p> <p>Ethernet only: Only provides the standby power for the Ethernet chip.</p> <p>No standby power: Shut down all of the standby power.</p>

BIOS Setting	Description
Serial Ports Configuration	Sets parameters of Serial Ports. Enables / Disables the serial port and select an optimal setting for the Super IO device.

4.4.5.1. Serial Port 1~6 Configuration

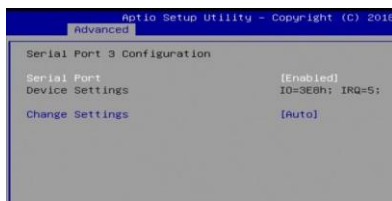
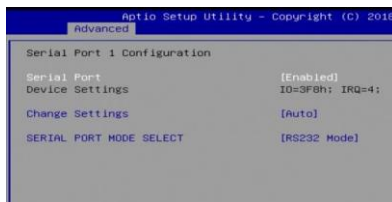

BIOS Setting	Description
Serial Ports	Enables / Disables the serial ports.

4.4.6 Hardware Monitor

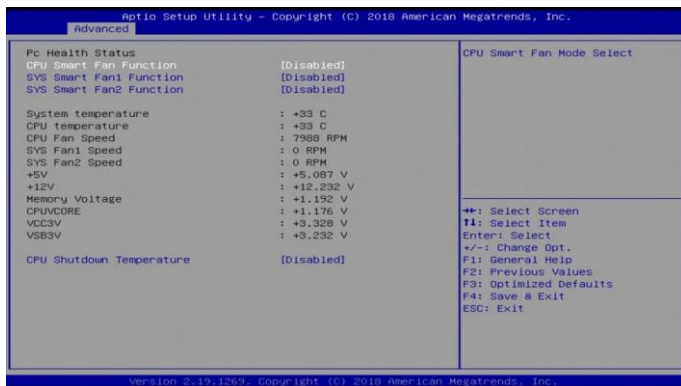

BIOS Setting	Description
CPU Smart Fan Function	Enables / Disables the CPU smart fan feature.
System Smart Fans Function	Enables / Disables the system smart fans feature.
Temperatures / Voltages	These fields are the parameters of the hardware monitoring function feature of the motherboard. The values are read-only values as monitored by the system and show the PC health status.
CPU Shutdown Temperature	Enables / Disables the CPU shutdown temperature function.

4.4.7 CPU Configuration

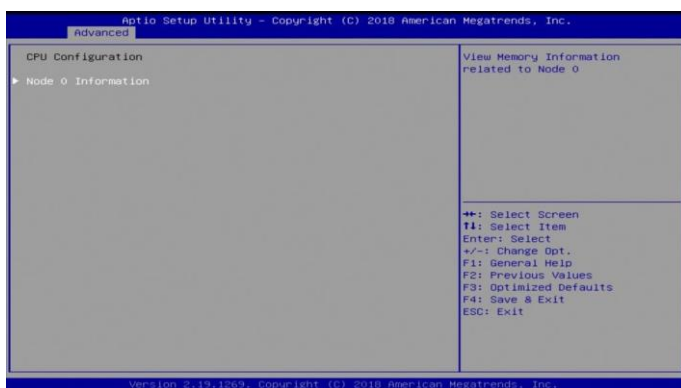

BIOS Setting	Description
Node 0 Information	Displays the memory information related to Node 0.

4.4.8 AMI Graphic Output Protocol Policy

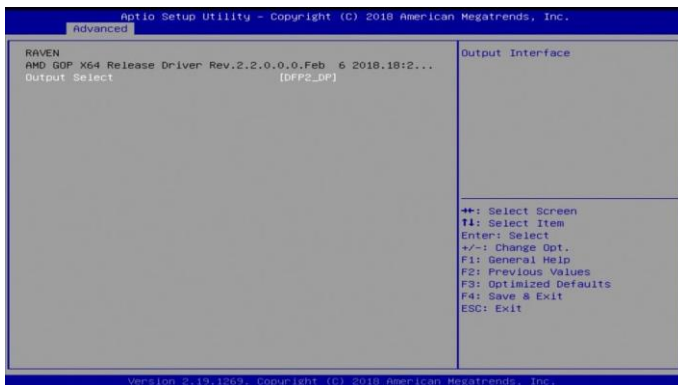

BIOS Setting	Description
Output Select	Allows you to select an output interface.

4.4.9 Network Stack Configuration

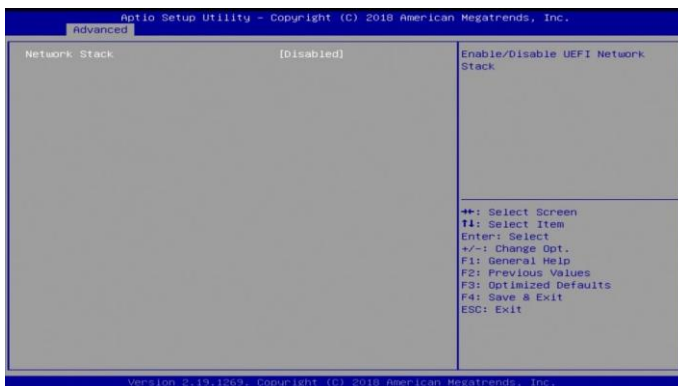

BIOS Setting	Description
Network Stack	Enables / Disables UEFI Network Stack.

4.4.10 CSM Configuration

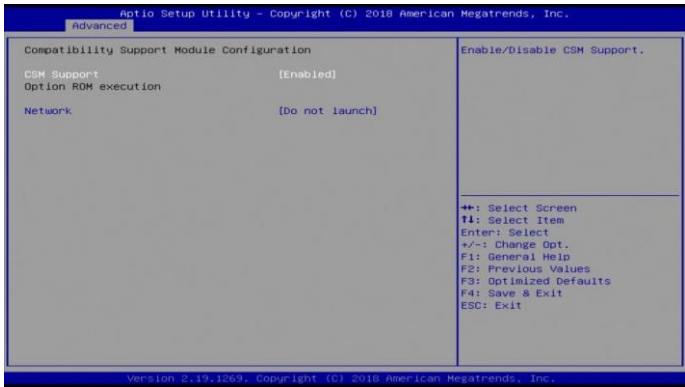

BIOS Setting	Description
CSM Support	Enables / Disables CSM support.
Network	Controls the execution of UEFI and Legacy PXE OpROM. Options: Do not launch / Legacy

4.4.11 NVMe Configuration

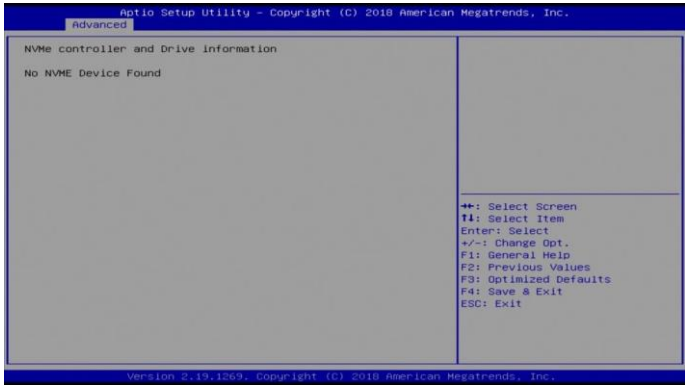

4.4.12 USB Configuration

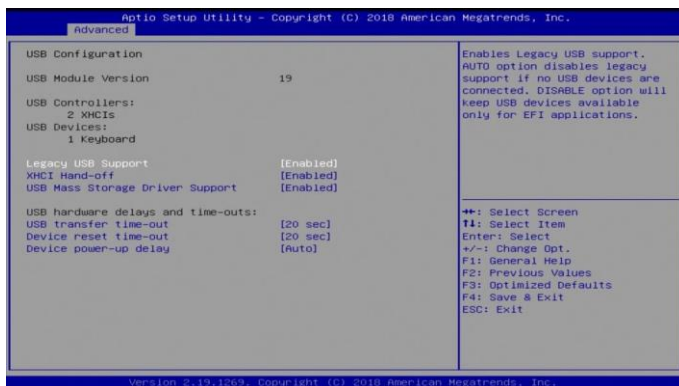

BIOS Setting	Description
Legacy USB Support	<p>Enables Legacy USB support.</p> <ul style="list-style-type: none"> • Auto disables legacy support if there is no USB device connected. • Disable keeps USB devices available only for EFI applications.
XHCI Hand-off	<p>This is a workaround for OSeS without XHCI hand-off support. The XHCI ownership change should be claimed by XHCI driver.</p>
USB Mass Storage Driver Support	<p>Enables / Disables the support for USB mass storage driver.</p>
USB Transfer time-out	<p>The time-out value for control, bulk, and Interrupt transfers.</p> <p>Options: 1 sec / 5 sec / 10 sec / 20 sec</p>
Device reset time-out	<p>Seconds of delaying execution of start unit command to USB mass storage device.</p> <p>Options: 10 sec / 20 sec / 30 sec / 40 sec</p>
Device power-up delay	<p>The maximum time the device will take before it properly reports itself to the Host Controller.</p> <p>Auto uses default value for a Root port it is 100ms. But for a Hub port, the delay is taken from Hub descriptor.</p> <p>Options: Auto / Manual</p>

4.5 Chipset Settings

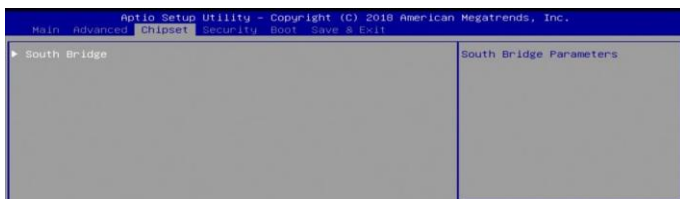

4.5.1 SB USB Configuration

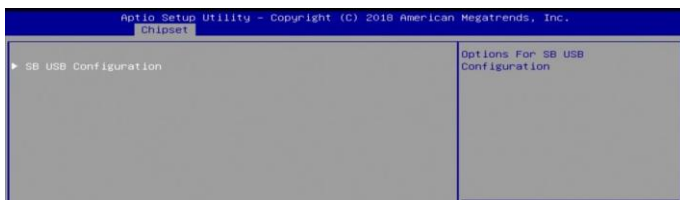

BIOS Setting	Description
SB USB Configuration	Options for SB USB Configuration.

4.5.1.1. XHCI Ports

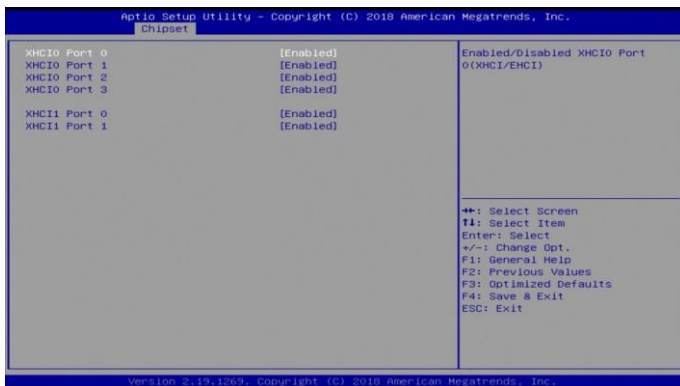

BIOS Setting	Description
XHCI 0 & XHCI 1 Ports	Enables / Disables the XHCI0 & XHCI1 ports (XHCI/EMCI).

4.6 Security Settings



BIOS Setting	Description
Administrator Password	Sets an administrator password for the setup utility.
User Password	Sets a user password.

4.7 Boot Settings

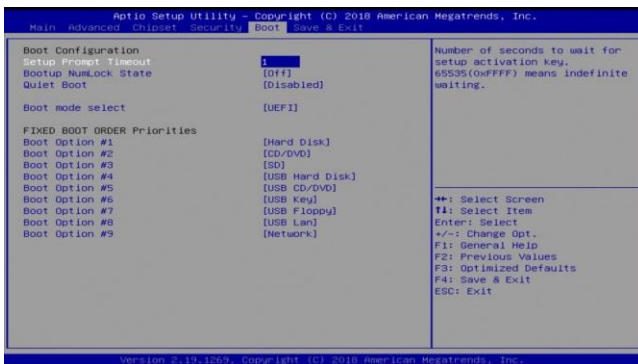

BIOS Setting	Description
Setup Prompt Timeout	Number of seconds to wait for setup activation key. 65535(0xFFFF) means indefinite waiting.
Bootup NumLock State	Selects the keyboard NumLock state.
Quiet Boot	Enables / Disables Quiet Boot option.
Boot mode select	Selects a Boot mode, Legacy / UEFI.
Boot Option Priorities	Sets the system boot order.

4.8 Save & Exit Settings



BIOS Setting	Description
Save Changes and Exit	Exits system setup after saving the changes.
Discard Changes and Exit	Exits system setup without saving any changes.
Save Changes and Reset	Resets the system after saving the changes.
Discard Changes and Reset	Resets system setup without saving any changes.
Save Changes	Saves changes done so far to any of the setup options.
Discard Changes	Discards changes done so far to any of the setup options.
Restore Defaults	Restores / Loads defaults values for all the setup options.
Save as User Defaults	Saves the changes done so far as User Defaults.
Restore User Defaults	Restores the user defaults to all the setup options.

Appendix

This section provides the mapping addresses of peripheral devices, the sample code of watchdog timer configuration, and types of onboard connectors.

A. I/O Port Address Map

Each peripheral device in the system is assigned a set of I/O port addresses which also becomes the identity of the device. The following table lists the I/O port addresses used.

Address	Device Description
0x00000A00-0x00000A0F	Motherboard resources
0x00000A10-0x00000A1F	Motherboard resources
0x00000A20-0x00000A2F	Motherboard resources
0x00000A30-0x00000A3F	Motherboard resources
0x00000A40-0x00000A4F	Motherboard resources
0x00000070-0x00000071	System CMOS/real time clock
0x0000D000-0x0000DFFF	PCI Express Root Port
0x0000D000-0x0000DFFF	AMD Radeon(TM) Vega 8 Graphics
0x000003F8-0x000003FF	Communications Port (COM1)
0x000002F8-0x000002FF	Communications Port (COM2)
0x000003E8-0x000003EF	Communications Port (COM3)
0x000002E8-0x000002EF	Communications Port (COM4)
0x00000238-0x0000023F	Communications Port (COM5)
0x00000338-0x0000033F	Communications Port (COM6)
0x00000020-0x00000021	Programmable interrupt controller
0x000000A0-0x000000A1	Programmable interrupt controller
0x00000000-0x000003AF	PCI Express Root Complex
0x00000000-0x000003AF	Direct memory access controller
0x000003E0-0x00000CF7	PCI Express Root Complex
0x000003B0-0x000003DF	PCI Express Root Complex
0x00000D00-0x0000FFFF	PCI Express Root Complex
0x0000F000-0x0000FFFF	PCI Express Root Port
0x0000E000-0x0000EFFF	PCI Express Root Port
0x00000040-0x00000043	System timer
0x00000010-0x0000001F	Motherboard resources

Address	Device Description
0x00000022-0x0000003F	Motherboard resources
0x00000063-0x00000063	Motherboard resources
0x00000065-0x00000065	Motherboard resources
0x00000067-0x0000006F	Motherboard resources
0x00000072-0x0000007F	Motherboard resources
0x00000080-0x00000080	Motherboard resources
0x00000084-0x00000086	Motherboard resources
0x00000088-0x00000088	Motherboard resources
0x0000008C-0x0000008E	Motherboard resources
0x00000090-0x0000009F	Motherboard resources
0x000000A2-0x000000BF	Motherboard resources
0x000000B1-0x000000B1	Motherboard resources
0x000000E0-0x000000EF	Motherboard resources
0x000004D0-0x000004D1	Motherboard resources
0x0000040B-0x0000040B	Motherboard resources
0x000004D6-0x000004D6	Motherboard resources
0x00000C00-0x00000C01	Motherboard resources
0x00000C14-0x00000C14	Motherboard resources
0x00000C50-0x00000C51	Motherboard resources
0x00000C52-0x00000C52	Motherboard resources
0x00000C6C-0x00000C6C	Motherboard resources
0x00000C6F-0x00000C6F	Motherboard resources
0x00000CD0-0x00000CD1	Motherboard resources
0x00000CD2-0x00000CD3	Motherboard resources
0x00000CD4-0x00000CD5	Motherboard resources
0x00000CD6-0x00000CD7	Motherboard resources
0x00000CD8-0x00000CDF	Motherboard resources
0x00000800-0x0000089F	Motherboard resources
0x00000B00-0x00000B0F	Motherboard resources
0x00000B20-0x00000B3F	Motherboard resources

Address	Device Description
0x00000900-0x0000090F	Motherboard resources
0x00000910-0x0000091F	Motherboard resources
0x00000061-0x00000061	System speaker
0x00000081-0x00000083	Direct memory access controller
0x00000087-0x00000087	Direct memory access controller
0x00000089-0x0000008B	Direct memory access controller
0x0000008F-0x0000008F	Direct memory access controller
0x000000C0-0x000000DF	Direct memory access controller

B. Interrupt Request Lines (IRQ)

Peripheral devices use interrupt request lines to notify CPU for the service required. The following table shows the IRQ used by the devices on board.

Level	Function
IRQ 4294967292	PCI Express Root Port
IRQ 0	High precision event timer
IRQ 0	System timer
IRQ 8	High precision event timer
IRQ 7	AMD GPIO Controller
IRQ 4294967272	AMD USB 3.10 eXtensible Host Controller - 1.10 (Microsoft)
IRQ 4294967271	AMD USB 3.10 eXtensible Host Controller - 1.10 (Microsoft)
IRQ 4294967270	AMD USB 3.10 eXtensible Host Controller - 1.10 (Microsoft)
IRQ 4294967269	AMD USB 3.10 eXtensible Host Controller - 1.10 (Microsoft)
IRQ 4294967268	AMD USB 3.10 eXtensible Host Controller - 1.10 (Microsoft)
IRQ 4294967267	AMD USB 3.10 eXtensible Host Controller - 1.10 (Microsoft)
IRQ 4294967266	AMD USB 3.10 eXtensible Host Controller - 1.10 (Microsoft)
IRQ 4294967265	AMD USB 3.10 eXtensible Host Controller - 1.10 (Microsoft)
IRQ 4	Communications Port (COM1)
IRQ 3	Communications Port (COM2)
IRQ 5	Communications Port (COM3)
IRQ 5	Communications Port (COM4)
IRQ 6	Communications Port (COM5)
IRQ 6	Communications Port (COM6)
IRQ 53	High Definition Audio Controller

Level	Function
IRQ 53	AMD Audio CoProcessor
IRQ 54	AMD High Definition Audio Controller
IRQ 54	Microsoft ACPI-Compliant System
IRQ 55	Microsoft ACPI-Compliant System
IRQ 55	AMD SFH KMDf I2C
IRQ 56 ~ IRQ 204	Microsoft ACPI-Compliant System
IRQ 256 ~ IRQ 511	Microsoft ACPI-Compliant System
IRQ 4294967294	PCI Express Root Port
IRQ 4294967293	PCI Express Root Port
IRQ 4294967291	PCI Express Root Port
IRQ 4294967275	AMD Radeon(TM) Vega 8 Graphics
IRQ 4294967274	AMD Radeon(TM) Vega 8 Graphics
IRQ 4294967273	AMD Radeon(TM) Vega 8 Graphics
IRQ 4294967290	Standard SATA AHCI Controller
IRQ 4294967264	AMD USB 3.10 eXtensible Host Controller - 1.10 (Microsoft)
IRQ 4294967263	AMD USB 3.10 eXtensible Host Controller - 1.10 (Microsoft)
IRQ 4294967262	AMD USB 3.10 eXtensible Host Controller - 1.10 (Microsoft)
IRQ 4294967261	AMD USB 3.10 eXtensible Host Controller - 1.10 (Microsoft)
IRQ 4294967260	AMD USB 3.10 eXtensible Host Controller - 1.10 (Microsoft)
IRQ 4294967259	AMD USB 3.10 eXtensible Host Controller - 1.10 (Microsoft)
IRQ 4294967258	AMD USB 3.10 eXtensible Host Controller - 1.10 (Microsoft)
IRQ 4294967257	AMD USB 3.10 eXtensible Host Controller - 1.10 (Microsoft)
IRQ 4294967287	Intel(R) I211 Gigabit Network Connection #5

Level	Function
IRQ 4294967286	Intel(R) I211 Gigabit Network Connection #5
IRQ 4294967285	Intel(R) I211 Gigabit Network Connection #5
IRQ 4294967284	Intel(R) I211 Gigabit Network Connection #5
IRQ 4294967283	Intel(R) I211 Gigabit Network Connection #5
IRQ 4294967282	Intel(R) I211 Gigabit Network Connection #5
IRQ 4294967281	Intel(R) I211 Gigabit Network Connection #6
IRQ 4294967280	Intel(R) I211 Gigabit Network Connection #6
IRQ 4294967279	Intel(R) I211 Gigabit Network Connection #6
IRQ 4294967278	Intel(R) I211 Gigabit Network Connection #6
IRQ 4294967277	Intel(R) I211 Gigabit Network Connection #6
IRQ 4294967276	Intel(R) I211 Gigabit Network Connection #6
IRQ 4294967289	AMD PSP 10.0 Device
IRQ 4294967288	AMD PSP 10.0 Device

C. Watchdog Timer Configuration

The Watchdog Timer (WDT) is used to generate a variety of output signals after a user programmable count. The WDT is suitable for use in the prevention of system lock-up, such as when software becomes trapped in a deadlock. Under these sorts of circumstances, the timer will count to zero and the selected outputs will be driven.

Under normal circumstance, you will need to restart the WDT at regular intervals before the timer counts to zero.

1. Sample Code: The file NCT6116D.H

```
//-----
//
// THIS CODE AND INFORMATION IS PROVIDED "AS IS" WITHOUT WARRANTY OF ANY
// KIND, EITHER EXPRESSED OR IMPLIED, INCLUDING BUT NOT LIMITED TO THE
// IMPLIED WARRANTIES OF MERCHANTABILITY AND/OR FITNESS FOR A PARTICULAR
// PURPOSE.
//
//-----
#ifndef __NCT6116D_H
#define __NCT6116D_H                                1
//-----
#define NCT6116D_INDEX_PORT      (NCT6116D_BASE)
#define NCT6116D_DATA_PORT      (NCT6116D_BASE+1)
//-----
#define NCT6116D_REG_LD          0x07
//-----
#define NCT6116D_UNLOCK          0x87
#define NCT6116D_LOCK            0xAA
//-----
unsigned int Init_NCT6116D(void);
void Set_NCT6116D_LD( unsigned char);
void Set_NCT6116D_Reg( unsigned char, unsigned char);
unsigned char Get_NCT6116D_Reg( unsigned char);
//-----
#endif      // __NCT6116D_H
```

2. Sample Code: The file MAIN.CPP

```
//-----
//
// THIS CODE AND INFORMATION IS PROVIDED "AS IS" WITHOUT WARRANTY OF ANY
// KIND, EITHER EXPRESSED OR IMPLIED, INCLUDING BUT NOT LIMITED TO THE
// IMPLIED WARRANTIES OF MERCHANTABILITY AND/OR FITNESS FOR A PARTICULAR
// PURPOSE.
//
//-----
#include <dos.h>
#include <conio.h>
#include <stdio.h>
#include <stdlib.h>
#include "NCT6116D.H"
//-----
int main (void);

void WDTInitial(void);
void WDTEnable(unsigned char);
void WDTDisable(void);

//-----
int main (void)
{
    char SIO;

    SIO = Init_NCT6116D();
    if (SIO == 0)
    {
        printf("Can not detect Nuvoton NCT6116D, program abort.\n");
        return(1);
    }

    WDTInitial();

    WDTEnable(10);

    WDTDisable();

    return 0;
}
//-----
void WDTInitial(void)
{
    unsigned char bBuf;
    Set_NCT6116D_LD(0x08); //switch
to logic device 8
    bBuf = Get_NCT6116D_Reg(0x30);
    bBuf &= (~0x01);
    Set_NCT6116D_Reg(0x30, bBuf); //Enable
WDTO
}
//-----
```

```
void WDTEnable(unsigned char NewInterval)
{
    unsigned char bBuf;

    Set_NCT6116D_LD(0x08); //switch
to logic device 8
    Set_NCT6116D_Reg(0x30, 0x01); //enable
timer

    bBuf = Get_NCT6116D_Reg(0xF0);
    bBuf &= (~0x08);
    Set_NCT6116D_Reg(0xF0, bBuf); //count
mode is second

    Set_NCT6116D_Reg(0xF1, NewInterval); //set timer
}
//-----
void WDTDisable(void)
{
    Set_NCT6116D_LD(0x08); //switch
to logic device 8
    Set_NCT6116D_Reg(0xF1, 0x00); //clear
watchdog timer
    Set_NCT6116D_Reg(0x30, 0x00);
//watchdog disabled
}
//-----
```

3. Sample Code: The file NCT6116D.CPP

```
//-----
//
// THIS CODE AND INFORMATION IS PROVIDED "AS IS" WITHOUT WARRANTY OF ANY
// KIND, EITHER EXPRESSED OR IMPLIED, INCLUDING BUT NOT LIMITED TO THE
// IMPLIED WARRANTIES OF MERCHANTABILITY AND/OR FITNESS FOR A PARTICULAR
// PURPOSE.
//
//-----
#include "NCT6116D.H"
#include <dos.h>
//-----
unsigned int NCT6116D_BASE;
void Unlock_NCT6116D (void);
void Lock_NCT6116D (void);
//-----
unsigned int Init_NCT6116D(void)
{
    unsigned int result;
    unsigned char ucDid;

    NCT6116D_BASE = 0x4E;
    result = NCT6116D_BASE;

    ucDid = Get_NCT6116D_Reg(0x20);
    if (ucDid == 0xC4)
        //NCT6116D??
        {           goto Init_Finish;           }

    NCT6116D_BASE = 0x2E;
    result = NCT6116D_BASE;

    ucDid = Get_NCT6116D_Reg(0x20);
    if (ucDid == 0xC4)
        //NCT6116D??
        {           goto Init_Finish;           }

    NCT6116D_BASE = 0x00;
    result = NCT6116D_BASE;

Init_Finish:
    return (result);
}
//-----
void Unlock_NCT6116D (void)
{
    outputb(NCT6116D_INDEX_PORT, NCT6116D_UNLOCK);
    outputb(NCT6116D_INDEX_PORT, NCT6116D_UNLOCK);
}
//-----
```

```
void Lock_NCT6116D (void)
{
    outportb(NCT6116D_INDEX_PORT, NCT6116D_LOCK);
}
//-----
void Set_NCT6116D_LD( unsigned char LD)
{
    Unlock_NCT6116D();
    outportb(NCT6116D_INDEX_PORT, NCT6116D_REG_LD);
    outportb(NCT6116D_DATA_PORT, LD);
    Lock_NCT6116D();
}
//-----
void Set_NCT6116D_Reg( unsigned char REG, unsigned char DATA)
{
    Unlock_NCT6116D();
    outportb(NCT6116D_INDEX_PORT, REG);
    outportb(NCT6116D_DATA_PORT, DATA);
    Lock_NCT6116D();
}
//-----
unsigned char Get_NCT6116D_Reg(unsigned char REG)
{
    unsigned char Result;
    Unlock_NCT6116D();
    outportb(NCT6116D_INDEX_PORT, REG);
    Result = inportb(NCT6116D_DATA_PORT);
    Lock_NCT6116D();
    return Result;
}
//-----
```

D. Onboard Connector Types

Function	Connector Name	Onboard Type	Compatible Mating Type for Reference
DC-In Power Connector	J1	Hao Guo Xing Ye ATX4PT-NY46	Molex 39-01-2040
LCD Backlight Connector	J8	E-Call 0110-161-040	JST PHR-4
LVDS Connector	J6, J7	HRS DF20F-20DP-1V	HRS DF20A-20DS-1C
SATA Power Connector	J11, J21	Hao Guo Xing Ye WAFER25-104S-2442-ST	Hao Guo Xing Ye J99-0215-01
Digital I/O Connector	J14	E-call 0126-01-203-100	Dupont 10P 2.54 mm-pitch (female)
Front Panel Settings Connector	J13	E-call 0126-01-203-080	Dupont 8P 2.54 mm-pitch (female)
COM5 & COM6 RS-232 Port	J18, J16	Hao Guo Xing Ye DF11-10S-PA66H	HRS DF11-10DS-2C
Speaker Connector	J17	JST B4B-PH-K-S	JST PHR-4
Audio Connector	J19	E-Call 0126-01-2821009	Dupont 10P 2.54 mm-pitch (female)
Fan Power Connectors	CPU_FAN1	TechBest W2-03I104132S1WT(A)-L	Molex 47054-1000
	SYS_FAN1, SYS_FAN2	E-Call 0110-02-111-030	Molex 22-01-2031