

GW-7552 PROFIBUS/MODBUS GATEWAY

User's Manual



High Quality, Industrial Data Acquisition, and Control Products

Warranty

All products manufactured by ICP DAS are under warranty regarding defective materials for a period of one year from the date of delivery to the original purchaser.

Warning

ICP DAS assumes no liability for damages resulting from the use of this product. ICP DAS reserves the right to change this manual at any time without notice. The information furnished by ICP DAS is believed to be accurate and reliable. However, no responsibility is assumed by ICP DAS for its use, or for any infringements of patents or other right of third parties resulting from its use.

Copyright

Copyright 2013 by ICP DAS. All rights are reserved.

Trademark

The names used for identification only may be registered trademarks of their respective companies.

List of Revision

Date	Author	Version	Revision
2013/04/05	Raiden	1.40	Release
2013/05/30	Elliot	1.50	Release

Table of Contents

1. Introduction.....	4
1.1 Features.....	5
1.2 Modules Support.....	5
1.3 Specification.....	5
2. Hardware.....	7
2.1 Block Diagram of GW-7552.....	7
2.2 Pin Assignment.....	7
2.3 Wiring and Jumper Setting Instructions.....	9
2.4 Setting the Profibus Address.....	14
2.5 LED status indicator.....	16
2.6 Normal/Setting Dip Switch.....	17
3. Communication protocol transfer theorem.....	19
3.1 Profibus data exchange.....	19
3.2 Modbus data exchange.....	22
3.3 Communication protocol transfer.....	25
4. Communication.....	29
4.1 Field of application.....	29
4.2 GSD file.....	30
4.3 The Configuration of the common parameters.....	33
4.4 The Configuration of the modules.....	34
4.5 Diagnostic messages.....	37
4.6 I/O data exchange.....	38
4.7 Establish connection with GW-7552.....	40
4.8 Data exchange example.....	41
5. Application of Utility.....	53
5.1 Install Utility.....	53
5.2 Utility introduction.....	56
5.3 Memory address configuration of the module.....	57
5.4 Safe value setting.....	60
5.5 Establish connection with GW-7552.....	62
6. Troubleshooting.....	65
7. Dimensions.....	66

1. Introduction

Profibus and Modbus are two kinds of famous protocols and are widely used in the fields of factory and process automation. The GW-7552 is a Profibus to Modbus gateway. By using this module, users can easily put the Modbus devices into Profibus network.

Figure 1 shows an application example for the GW-7552 module.

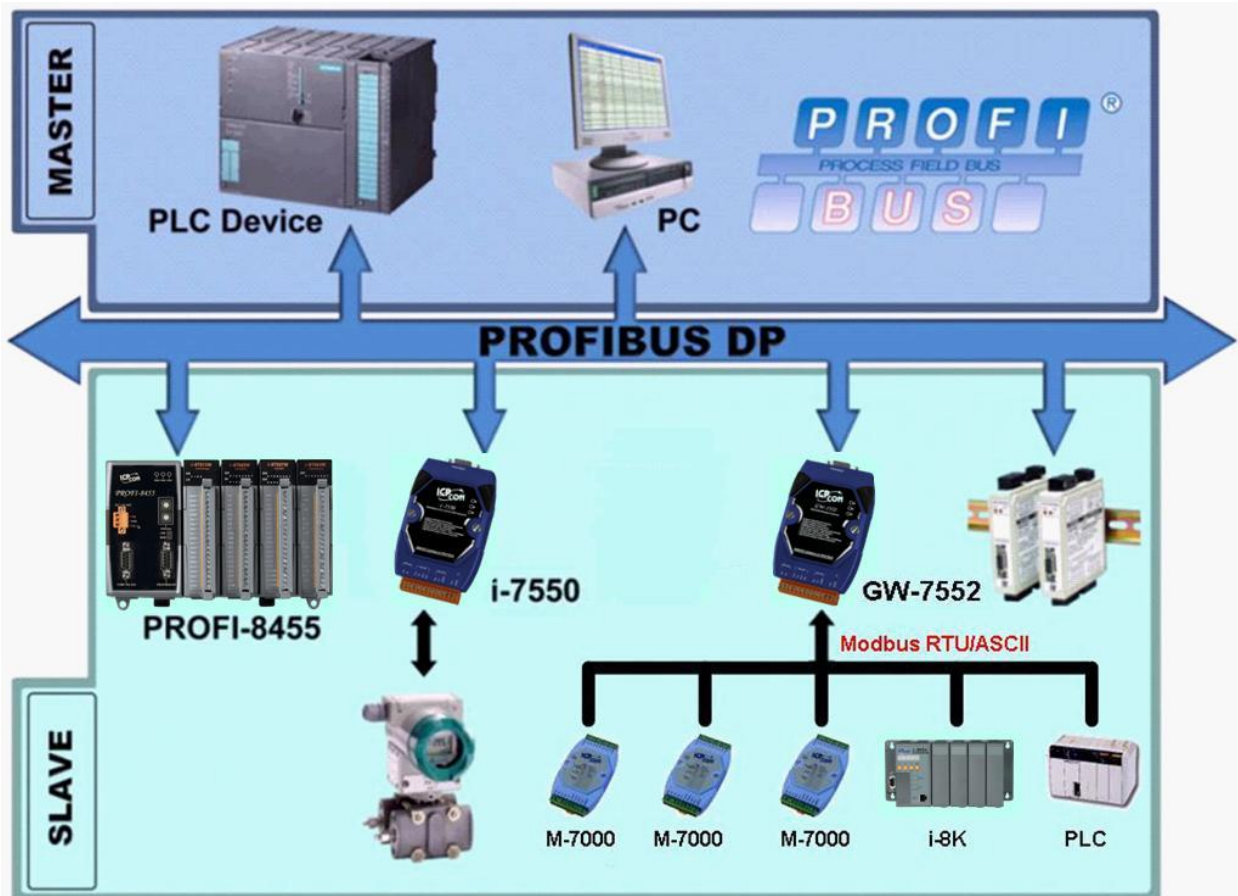

Figure 1 Application architecture of the GW-7552 module

The GW-7552 Gateway is specially designed for the slave device of PROFIBUS DP protocol. In the Modbus protocol application, the GW-7552 can be a Modbus master device or slave device. The Modbus devices can exchange data with the Profibus master device via the GW-7552 module.

The main features and specification of GW-7552 are described as below:

1.1 Features

- 16-Bit Microprocessor inside with 80MHz
- Siemens SPC3 PROFIBUS controller
- Supports PROFIBUS DP-V0 slave
- PROFIBUS transmission rate detect automatically
- Max transmission speed up to 12M bps for PROFIBUS and 115.2K bps for COM Port
- Supports Modbus RTU/ASCII format
- Supports Modbus master/slave mode
- Supports safe value setting
- COM Port driver has 1K bytes QUEUE input buffer & 512 bytes QUEUE output buffer
- Max length of output/input data is 131/132 Bytes
- Built-in self-tuner ASIC controller on RS-422/485 port
- 2500Vrms High Speed iCoupler Isolation Protection for PROFIBUS network
- 3000VDC Isolation Protection on the PROFIBUS side
- Provide LED indicators
- Built-in Watchdog
- Mountable on DIN Rail

1.2 Modules Support

Only the following Modbus commands are supported by the gateway.

Table 1: Modbus function codes

Code	Name	Description
01	Read Coil Status	Read the ON/OFF status of discrete outputs in the slave
02	Read Input Status	Read the ON/OFF status of discrete inputs in the slave
03	Read Holding Registers	Read the binary contents of holding registers in the slave
04	Read Input Registers	Read the binary contents of input registers in the slave
05	Force Single Coil	Write a single output to either ON or OFF in the slave
06	Preset Single Register	Write an integer value into a single register in the slave
15	Force Multi. Coils	Write each coil in the sequence of coils to either ON or OFF in the slave
16	Preset Multi. Registers	Write a block of contiguous registers in the slave

1.3 Specification

COM Port specs:

- Serial port - RS-232/RS-422/RS-485
- Serial port interface: 14-pin screw terminal block

- Baud Rate : 2400/4800/9600/19200/38400/57600/115200 bps
- Data Format: 7/8 data bits, None/Odd/Even parity bit, 1/2 stop bit

PROFIBUS specs:

- PROFIBUS interface connector: D-sub 9-pin female
- Baud Rate: 9.6K/19.2K/45.45K/93.75K/187.5K/500K/1.5M/3M/6M/ 12Mbps
- Address Setting: 0~126 (set by DIP switch or EEPROM)

Power requirement:

- Unregulated +10V ~ +30V DC
- Power reverse protection, Over-Voltage brown-out protection
- Power consumption 2.5W

Module specs:

- Dimensions: 119mm X 72mm X 33mm
- Operating temperature: -25 ~ 75 °C
- Storage temperature: -30 ~ 85 °C
- Humidity : 5 ~ 95%, non-condensing
- LED Status Indicators(*Table 2*)

Table 2: LED status indicator

PWR LED	– Shows the power state – COM Port state: transmit or receive data
ERR LED	– Show error state
RUN LED	– Show communication state of PROFIBUS

2. Hardware

2.1 Block Diagram of GW-7552

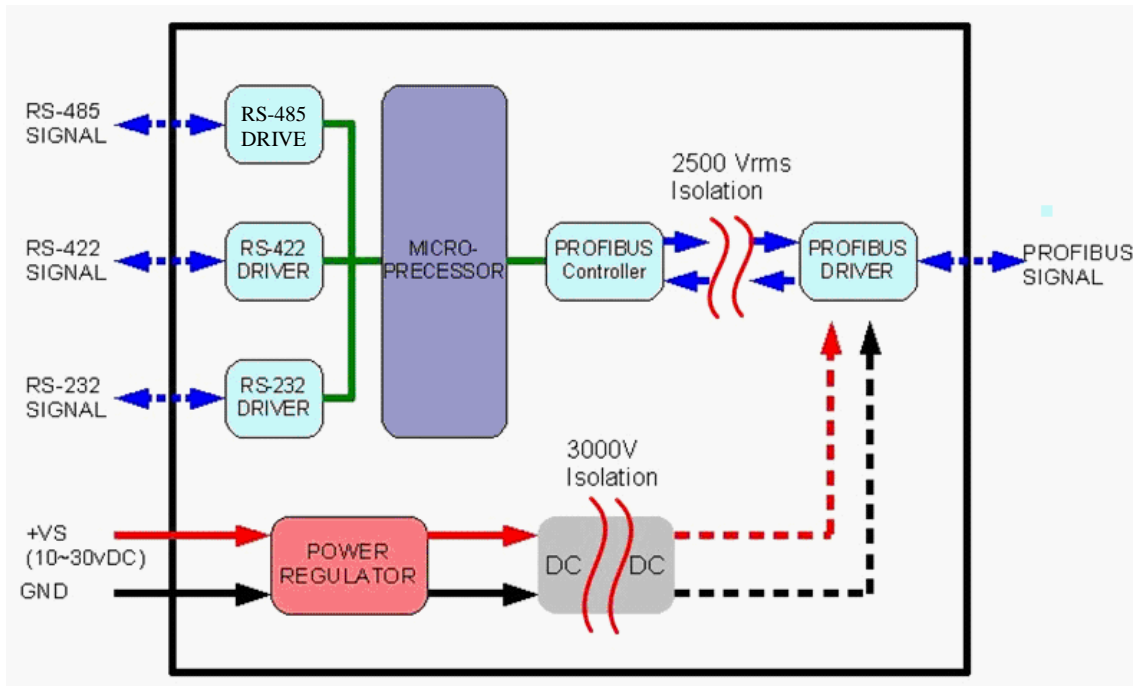

Figure 2 Block diagram of GW-7552

2.2 Pin Assignment

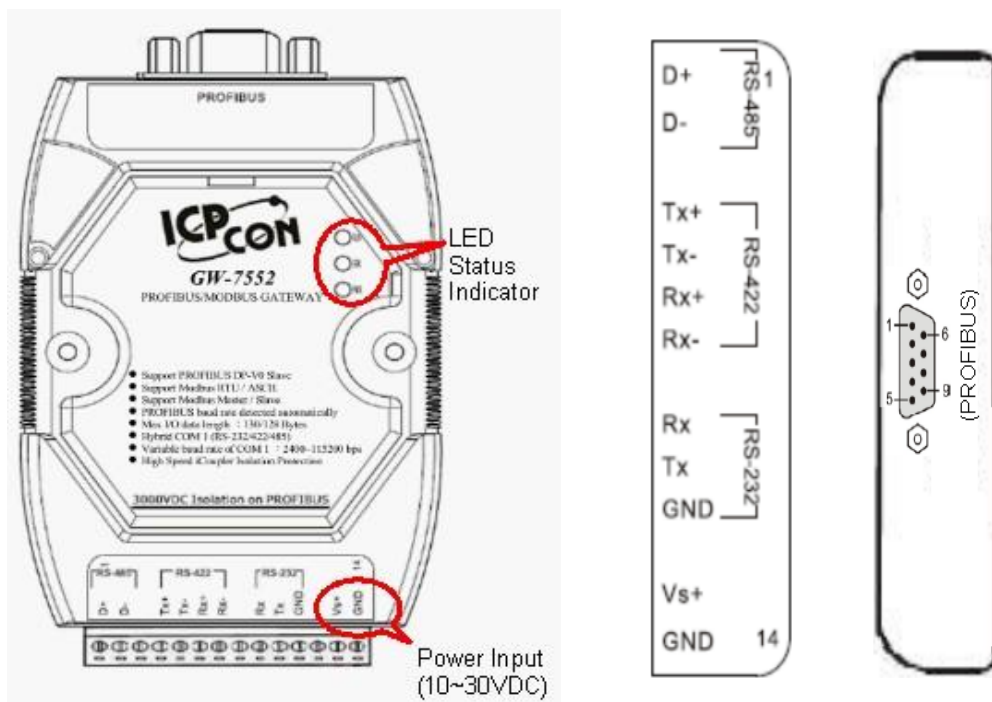

Figure 3 Pin assignment of GW-7552

Table 3 14-pin screw terminal block

Pin	Name	Description
1	D+	Data+ of RS-485
2	D-	Data- of RS-485
3	-	N/A
4	TX+	Transmit Data+ of RS-422
5	TX-	Transmit Data- of RS-422
6	RX+	Receive Data+ of RS-422
7	RX-	Receive Data- of RS-422
8	-	N/A
9	RX	Receive Data of RS-232
10	TX	Transmit Data of RS-232
11	GND	GND of RS-232
12	-	N/A
13	+VS	V+ of Power Supply(+10 to +30VDC)
14	GND	GND of Power Supply

Table 4 PROFIBUS DB9 Female Connector

Pin	Name	Description
1	-	N/A
2	-	N/A
3	B	Non-inverting Bus Line
4	ISODE	Isolated DE output for use in PROFIBUS applications where the state of the isolated drive enable node needs to be monitored.
5	GND	Power supply ground for the first node and the last node
6	VP	+5V Power Supply for the first node and the last node
7	-	N/A
8	A	Inverting Bus Line
9	-	N/A

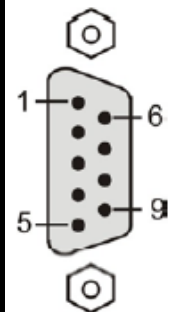

2.3 Wiring and Jumper Setting Instructions

The GW-7552 module supports PROFIBUS to Serial Port communication. It is recommended to use only one serial port (RS232, RS485 or RS422) of the Gateway at the same time. The following section describes the necessary steps to be taken to connect one of the three COM port types to a Modbus network.

2.3.1 RS-232 connection

The RS-232 port of the GW-7552 has got three pins. The wiring of the RS-232 device with the RS232 port of the GW-7552 is shown in *figure 4*.

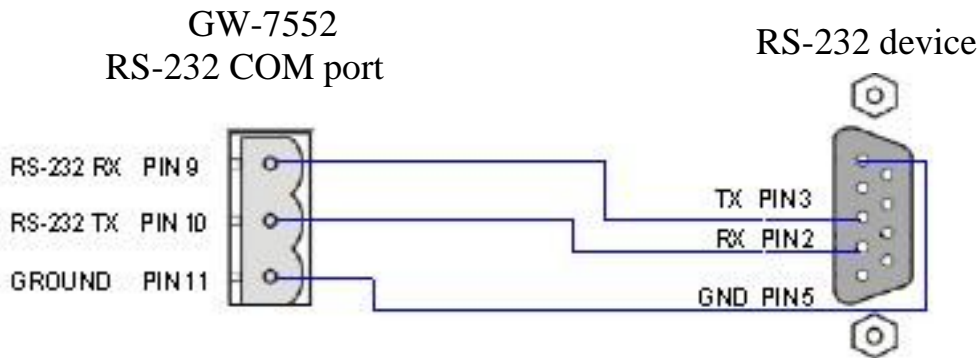

Figure 4 RS-232 wiring diagram

2.3.2 RS-422 connection

The RS-422 wiring connection is shown in *figure 5*.

The GW-7552 gateway can be a Modbus master or Modbus slave in a local RS-422 network. Depending on whether the gateway acts as a Modbus master or as a Modbus slave and on the number of devices connected to the RS-422 network device the four jumpers provided by the module has to be set according to *table 5*. The jumpers set the pull high and pull down resistors for the RS-422 port (*Figure 6, Figure 7*).

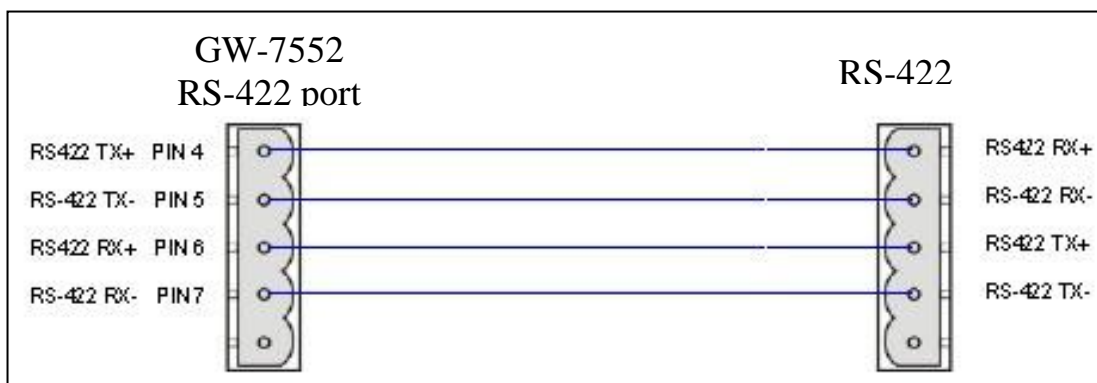
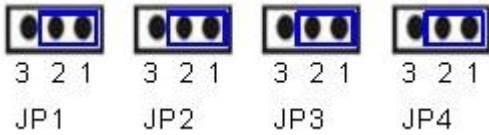
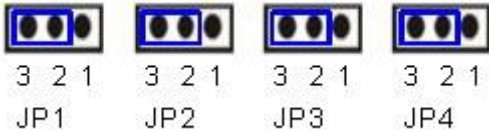

Figure 5 RS-422 connection

Table 5 Jumper position for the RS-422 port

Pull high/low resistor	Condition
<p>Enabled (default)</p>  <p>3 2 1 3 2 1 3 2 1 3 2 1 JP1 JP2 JP3 JP4</p>	<ul style="list-style-type: none"> – The GW-7552 is the master in RS-422 bus or – the number of devices connected to the RS-422 bus is less than 10
<p>Disabled</p>  <p>3 2 1 3 2 1 3 2 1 3 2 1 JP1 JP2 JP3 JP4</p>	<ul style="list-style-type: none"> – The GW-7552 is a slave in RS-422 bus or – the number of devices connected to the RS-422 bus exceeds 10

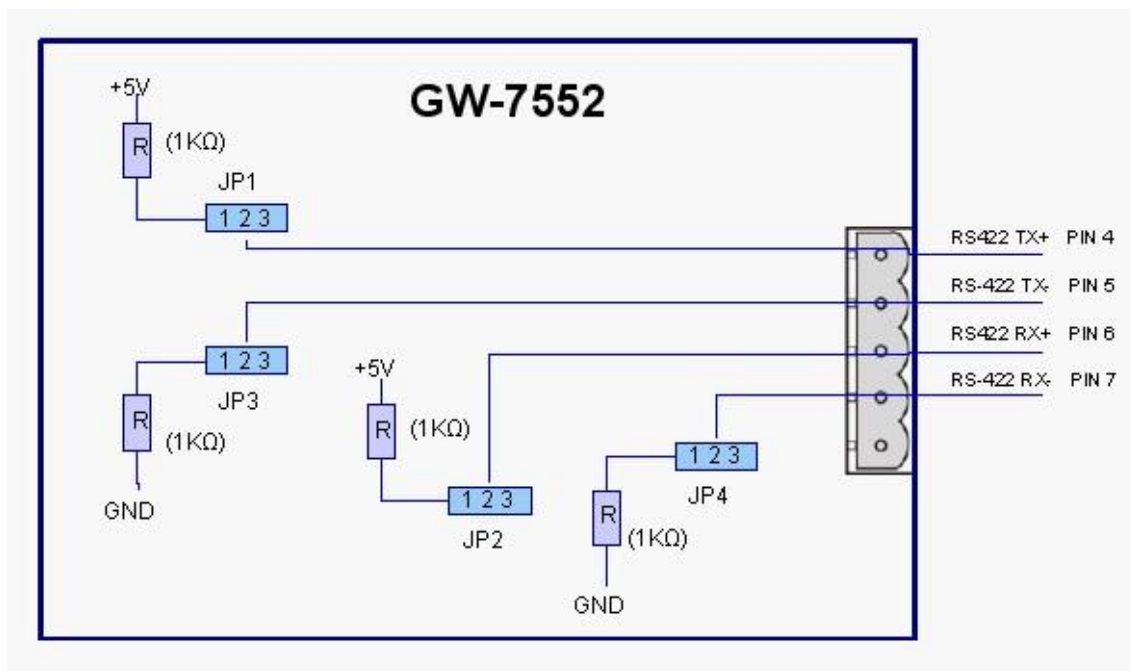

Figure 6 Configuration of pull high/low resistor for the RS-422 port

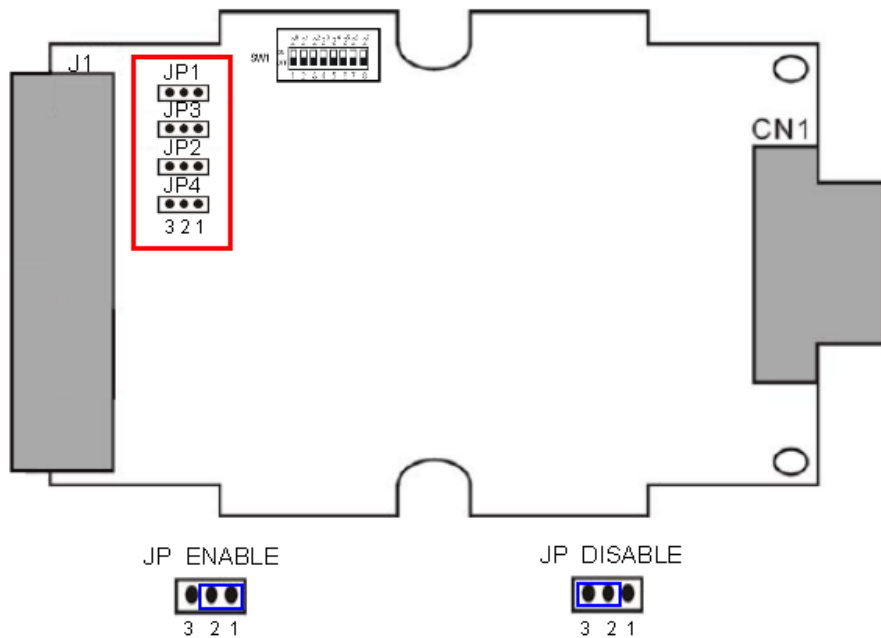

Figure 7 The positions of pull high/low resistors in GW-7552 module

2.3.3 RS-485 connection

The RS-485 wiring diagram is shown in figure 8.

The GW-7552 gateway can be a Modbus master or Modbus slave in a local RS-485 network. Depending on whether the gateway acts as a Modbus master or as a Modbus slave and on the number of devices connected to the RS-485 network device the four jumpers provided by the module has to be set according to Table 6. The jumpers set the pull high and pull down resistors for the RS-485 port (Figure 9).

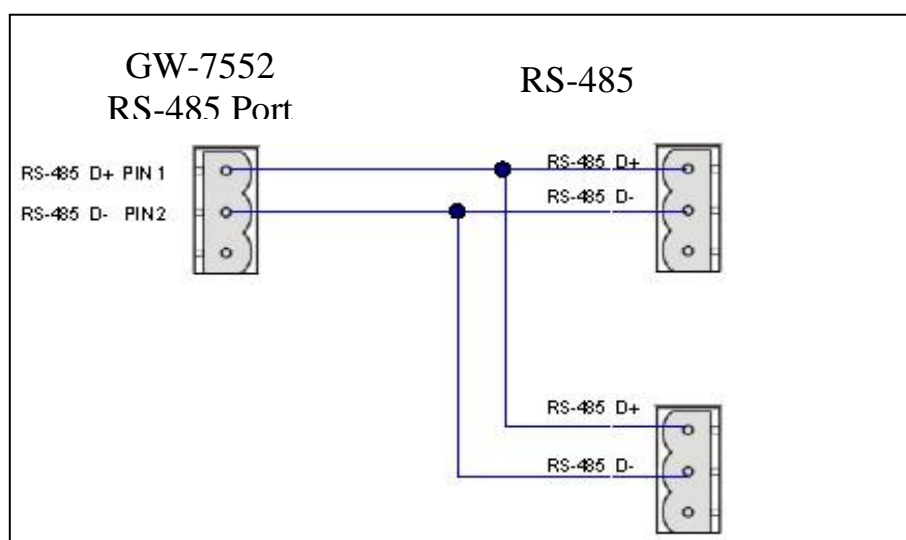
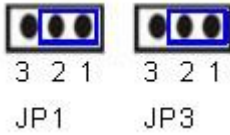
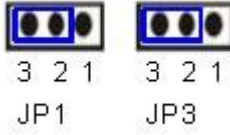

Figure 8 RS-485 connection

Table 6 Jumper position for the RS-485 port

Pull high/low resistor	Condition
<p>Enabled (default)</p>  <p>3 2 1 3 2 1 JP1 JP3</p>	<ul style="list-style-type: none"> – The GW-7552 is the master in RS-485 bus or – the number of devices connected to the RS-485 bus is less than 10
<p>Disabled</p>  <p>3 2 1 3 2 1 JP1 JP3</p>	<ul style="list-style-type: none"> – The GW-7552 is a slave in RS-485 bus or – the number of devices connected to the RS-485 bus exceeds 10

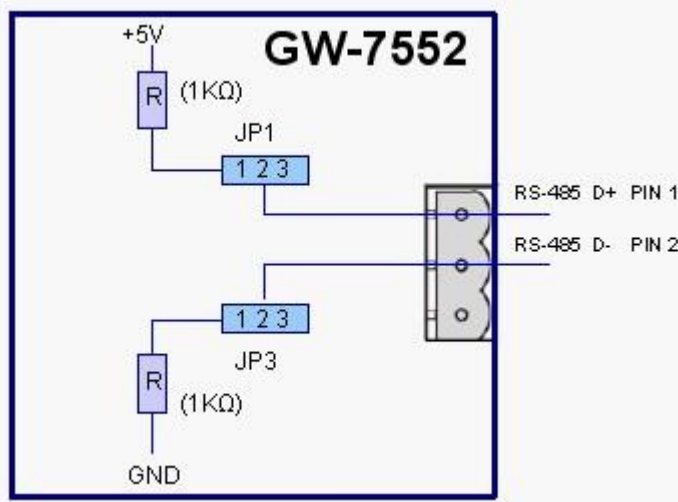

Figure 9 Configuration of pull high/low resistor for the RS-485 port

2.3.4 PROFIBUS Connection

The PROFIBUS interface of the GW-7552 is a DB9 female connector. The connector uses the standard Profibus 9 pin assignment. It is recommended to use a standard PROFIBUS cable and connector (DB9 male). As with every serial bus the rate of safe data transmission in a Profibus network decreases with increasing distance between master and slave. *Table 7* shows the transmission

rate and range for a cable with the following properties:

1. Impedance :135~165Ω
2. Capacity : lower than 30 pF/m
3. Loop resistance : lower than 110Ω/Km
4. Wire diameter : greater than 0.65mm
5. Core cross-section : greater than 0.34mm²

Table 7 Transmission rate decreasing with increasing transmission distance

Transmission Rate(Kbps)	Transmission Distance per Segment (meter)
9.6; 19.2; 45.45;93.75	1200
187.5	1000
500	400
1500	200
3000; 6000; 12000	100

In order to minimize the reflection effect of signal transmission, both ends (first node and last node) of a PROFIBUS segment needs to be equipped with an active terminal resistor as shown in *figure10*. A standard PROFIBUS connector is usually already equipped with a terminal resistor. The user therefore only has to switch on the resistor of the devices stationed at the ends of a segment as shown in *figure11*.

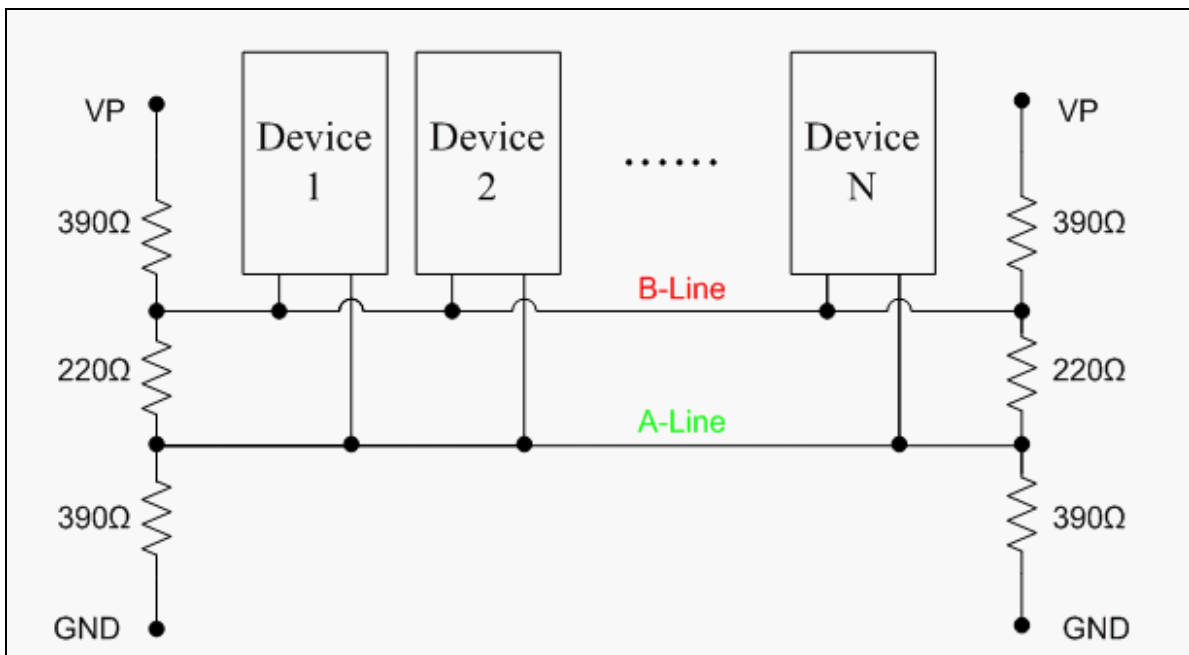

Figure 10 PROFIBUS connection

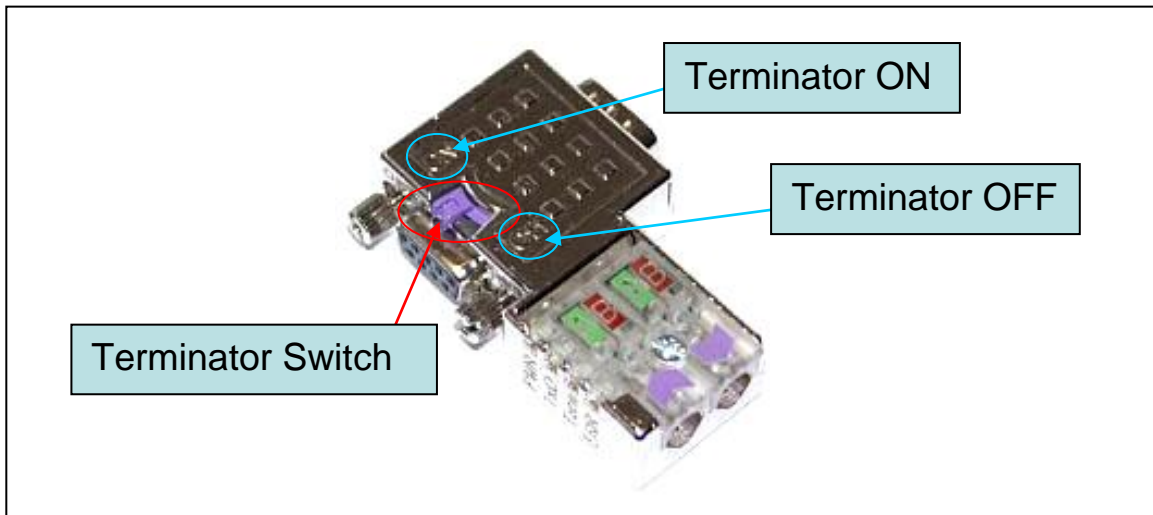

Figure 11 PROFIBUS connector

The number of stations in a Profibus network is restricted to 126. According to the PROFIBUS specification up to 32 stations are allowed per segment. A repeater has to be used to link the bus segments.

2.4 Setting the Profibus Address

The station address of GW-7552 can be set by using either the dip switch or by writing it directly to the EEPROM. The dip switch covers a range from 0 to 255. The valid address range of a Profibus station spans from 0 to 126. *Table 8* shows three examples of setting the station address by using the dip switch. The dip switches are accessed by opening the modules housing (*Figure 12*). *Table 9* explains which address will be used by the module after power on, if the dip switch address setting differs from the address stored in the EEPROM.

Table 8: Dip switch setting example

Station address	DIP SWITCH(SW1)							
	1	2	3	4	5	6	7	8
1	1	0	0	0	0	0	0	0
10	0	1	0	1	0	0	0	0
126	0	1	1	1	1	1	1	0

Table 9: The Address setting of the GW-7552

Dip Switch Setting	Description
0~125	<ol style="list-style-type: none"> The address setting of the EEPROM is ignored. The address can not be set by the PROFIBUS configuration tool.
126-254	<ol style="list-style-type: none"> The address setting of the dip switch is ignored. If the address in the EEPROM is 126, the PROFIBUS configuration tool can set a new address and save it to the EEPROM.
255	<ol style="list-style-type: none"> Slave address in the EEPROM is set to 126.

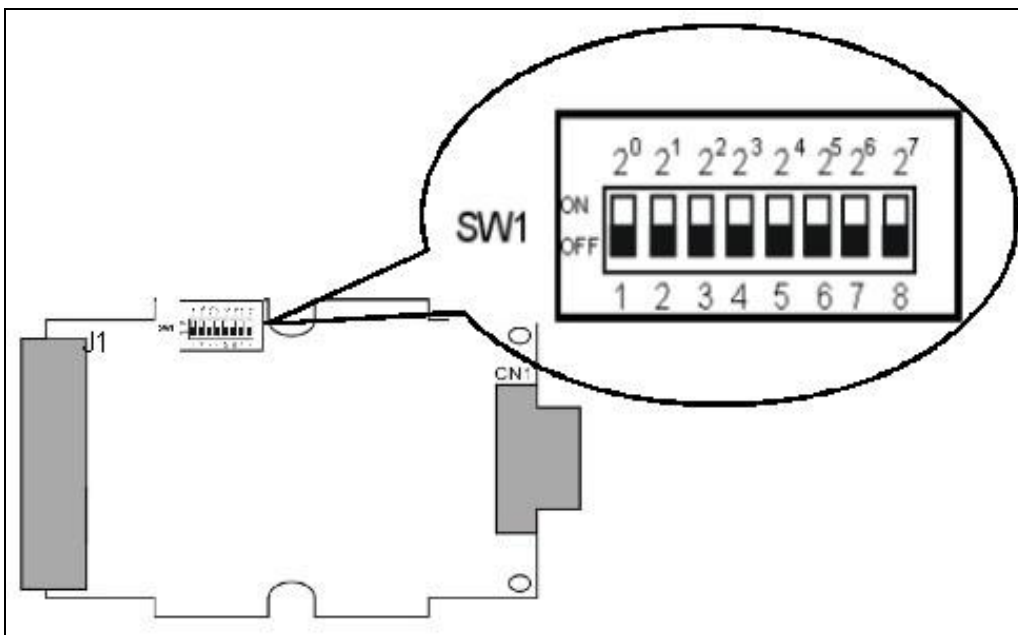

Figure 12: DIP switch

Each slave must have a unique valid address (1 to 125) in order to be able to communicate with the master. To change the address by using the configuration tool it is necessary to first set the address stored in the EEPROM to 126. This is done by setting the dip switch to 255 in the power off state. Switching the module on is forcing the module to change its address in the EEPROM to 126. In the next step switch the module off and change the dip switch setting to any value from 126 to 254. This step is necessary in order to prevent the module to change its address in the EEPROM to 126 every time it is powered on. The configuration tool can now assign the slave a new address.

2.5 LED status indicator

The GW-7552 provides three LEDs to indicate the statuses of the GW-7552 module. The position of LEDs and descriptions are shown in *table 10* and *figure 13*.

Table 10: LED status description

LED Name	Status	Description
PWR	flash	When the GW-7552 acts as a Modbus slave device and receiving query message form Modbus master device, PWR led will flash.
	on	Power supply is ok. The firmware has loaded.
	off	Power supply has failed.
ERR	flash	When the GW-7552 connects with the utility tool, it will flash fast (flash once about 55ms). When the GW-7552 has diagnostic message, it will flash slowly (flash once about 220ms).
	on	<ul style="list-style-type: none"> – Connection error between Profibus master and slave or – Profibus system has not been configured correctly.
	off	Normal operation PROFIBUS system has been configured correctly
RUN	on	Data exchange mode Normal operation.
	off	GW-7552 module is not in a data exchange mode.



Figure 13 LED position

2.6 Normal/Setting Dip Switch

There is a dip switch on the back of the GW-7552 module, as shown in *Figure 14*. The dip switch is used to set the GW-7552 module works in operation mode or setting mode. In the normal situation, it needs to set the dip switch to the “Normal” position. In this case, the GW-7552 module can communicate with Modbus devices. When the user sets the dip switch to the “Setting” position, the GW-7552 module can communicate with the utility tool to set the safe value.

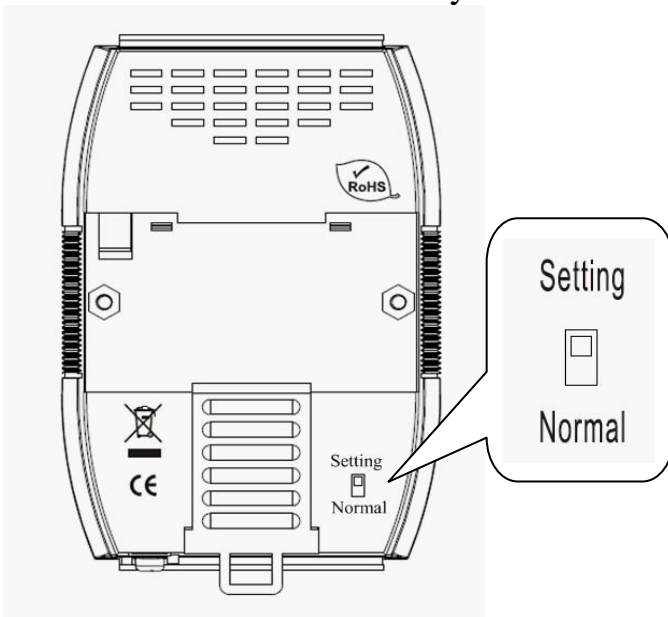

Figure 14 Dip switch of the GW-7552

PS:

There are two kinds of methods to enable the setting mode of the GW-7552. The user can change the position of the dip switch or set the control bit (please refer section 4.6.2 Output data area and communication command) to enable the setting mode of the GW-7552, as shown in *table 11*.

Table 11 Mode of GW-7552

Mode	SM(control bit)=0	SM(control bit)=1
Dip switch=Normal	operation mode	setting mode
Dip switch =Setting	setting mode	setting mode

3. Communication protocol transfer theorem

3.1 Profibus data exchange

The GW-7552 is a Profibus DP slave device. The GW-7552 is first parameterized then configured and finally it goes into the data exchange mode (*Figure 15*).

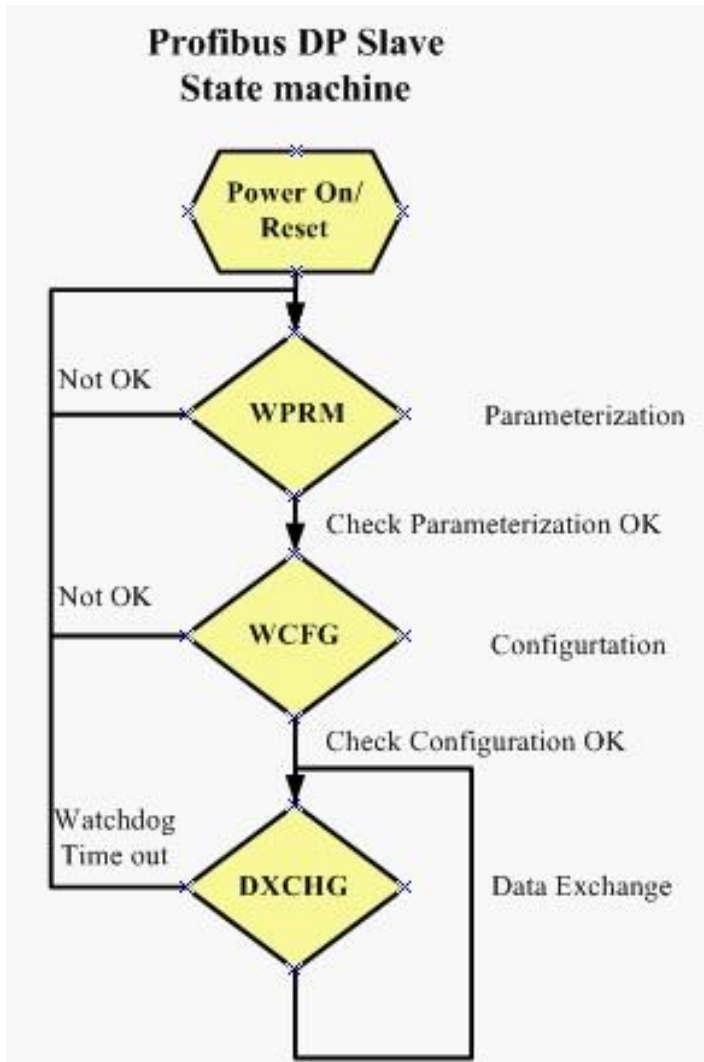

Figure 15 State machine of Profibus DP slave device

The GW-7552 exchanges data cyclically between internal DI、DO、AI、AO data and Profibus master device in data exchange mode, as shown in *figure 16*.

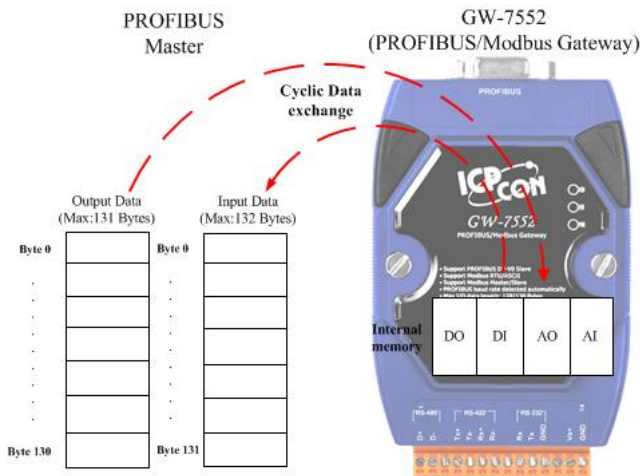

Figure 16 Data exchange between Profibus master device and GW-7552

The GW-7552 downloads the parameter and configuration from Profibus master device to be the module parameters. The GW-7552 and Profibus master device have different data type and data address, the GW-7552 can transfer different data format to Profibus master device through module parameters. When the GW-7552 acts as a Modbus master device, it will send DI \ AI data to input data area of Profibus master device and it will save data that receives from Profibus master device to internal DO \ AO memory space , as shown in figure 17 \ 18.

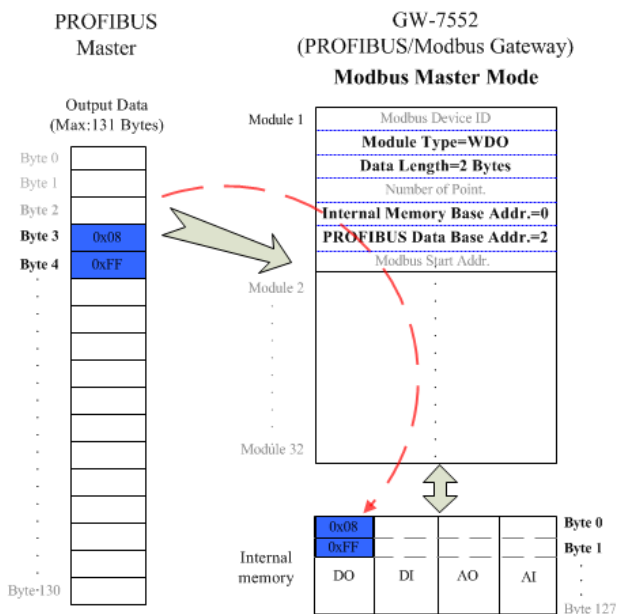

Figure 17 the output data of Profibus master device send to the GW-7552

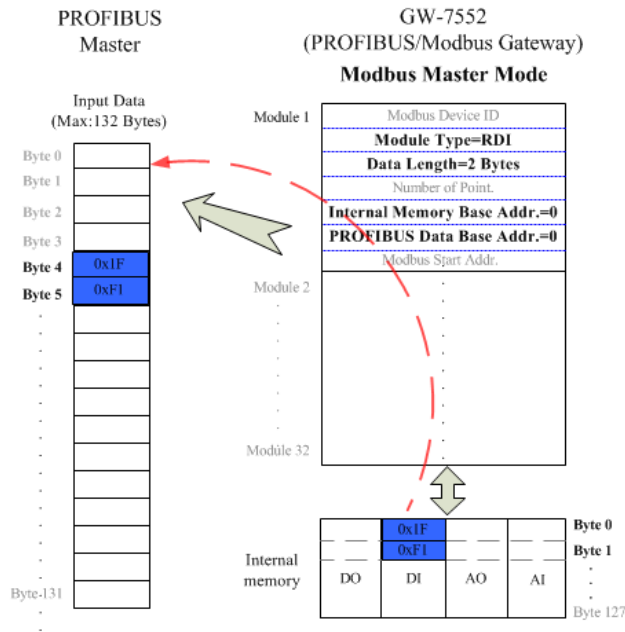

Figure 18 the input data of Profibus master device receive from the GW-7552

When the GW-7552 acts as a Modbus slave device, it will send DO、AO data to input data area of Profibus master device and it will save data that receives from Profibus master device to internal DI、AI memory space, as shown in figure 19、20.

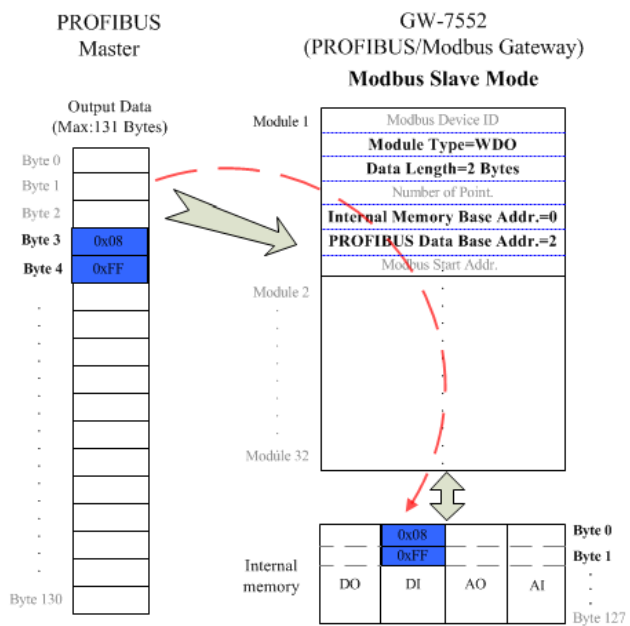

Figure 19 the output data of Profibus master device send to the GW-7552

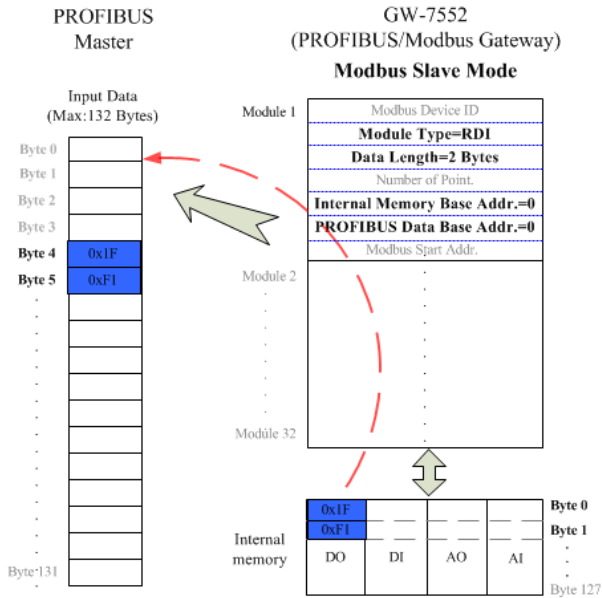

Figure 20 the input data of Profibus master device receive from the GW-7552

3.2 Modbus data exchange

Modbus protocol belongs to Master-Slave communication and it uses query and response message to arrive at data exchange and device control, as shown in figure 21.

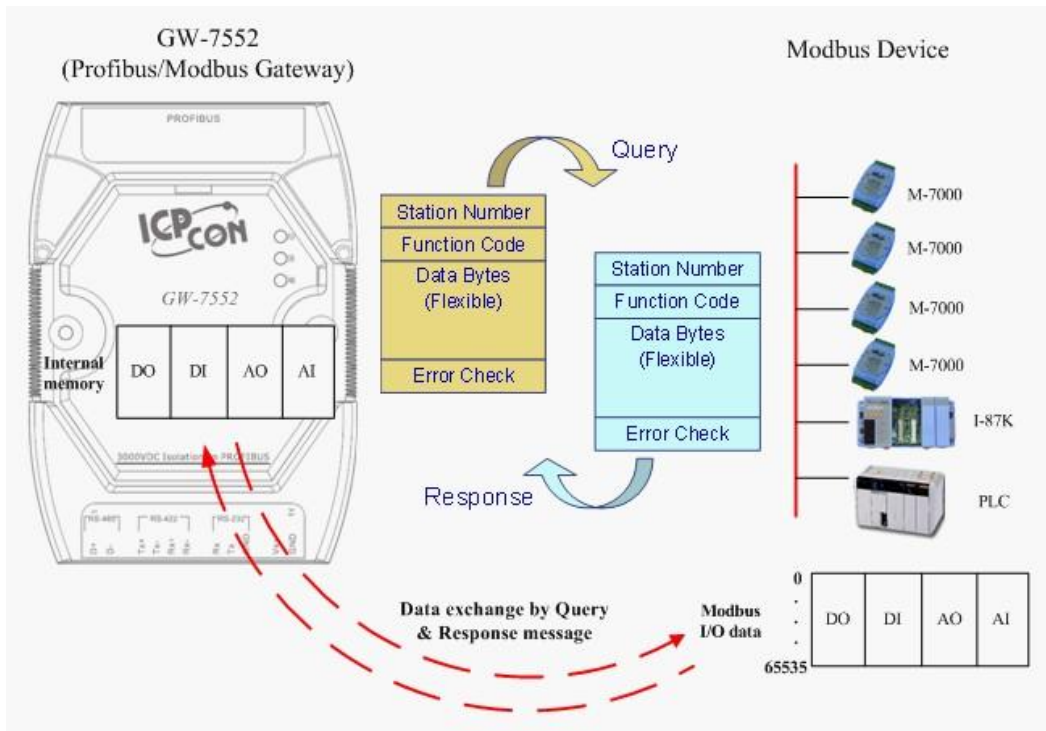

Figure 21 Data exchange between the Modbus devices and the GW-7552

When the GW-7552 acts as a Modbus master device, it can get query message through module parameter and DO、AO data and send query message to Modbus slave device. It can also receive response message form Modbus slave device and then saving to internal DI、AI memory space, as shown in *figure 22、23*.

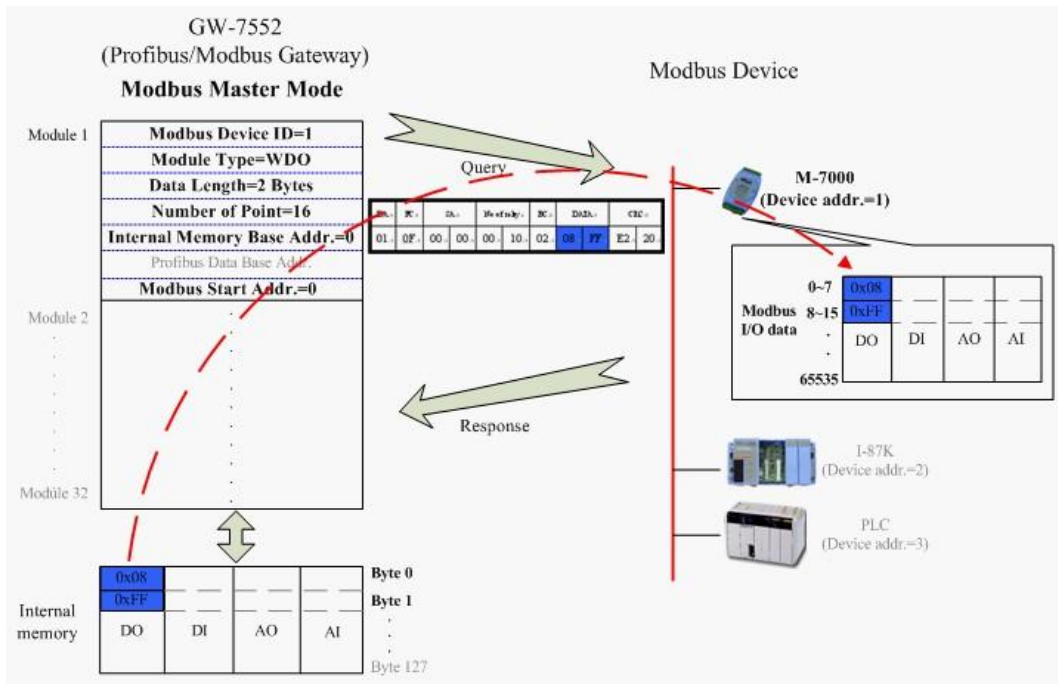

Figure 22 GW-7552 output data to modbus slave devices

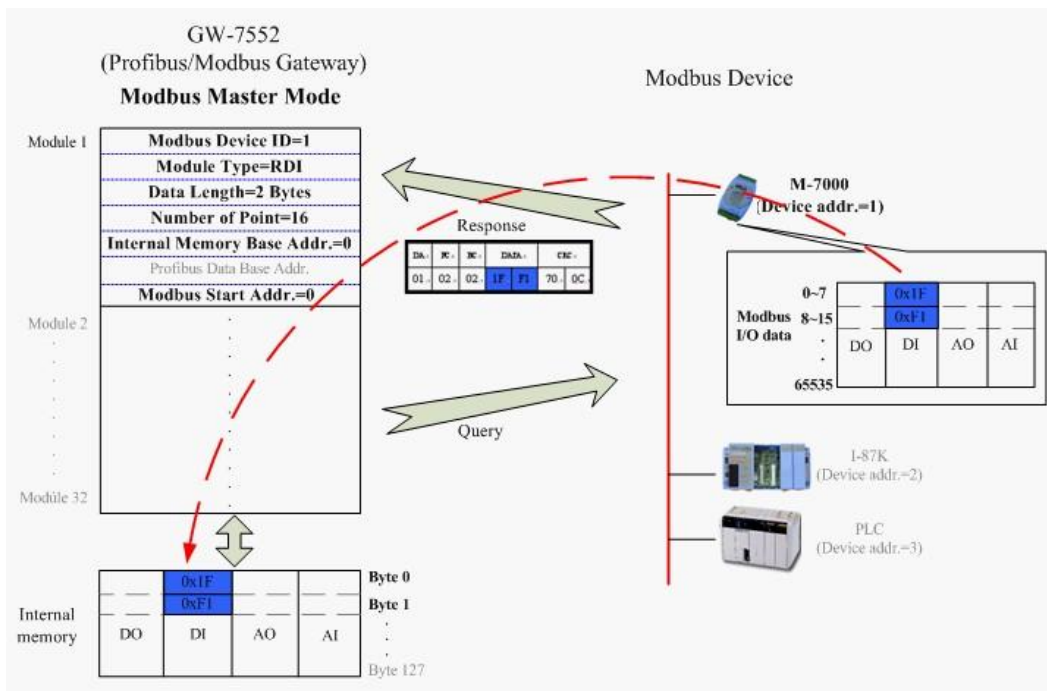

Figure 23 GW-7552 receive data from modbus slave devices

When the GW-7552 acts as a Modbus slave device, it can receive query message from Modbus master device and then saving to internal DO、AO memory space. It can also send response message to Modbus master device through internal DI、AI data, as shown in *figure 24、25*.

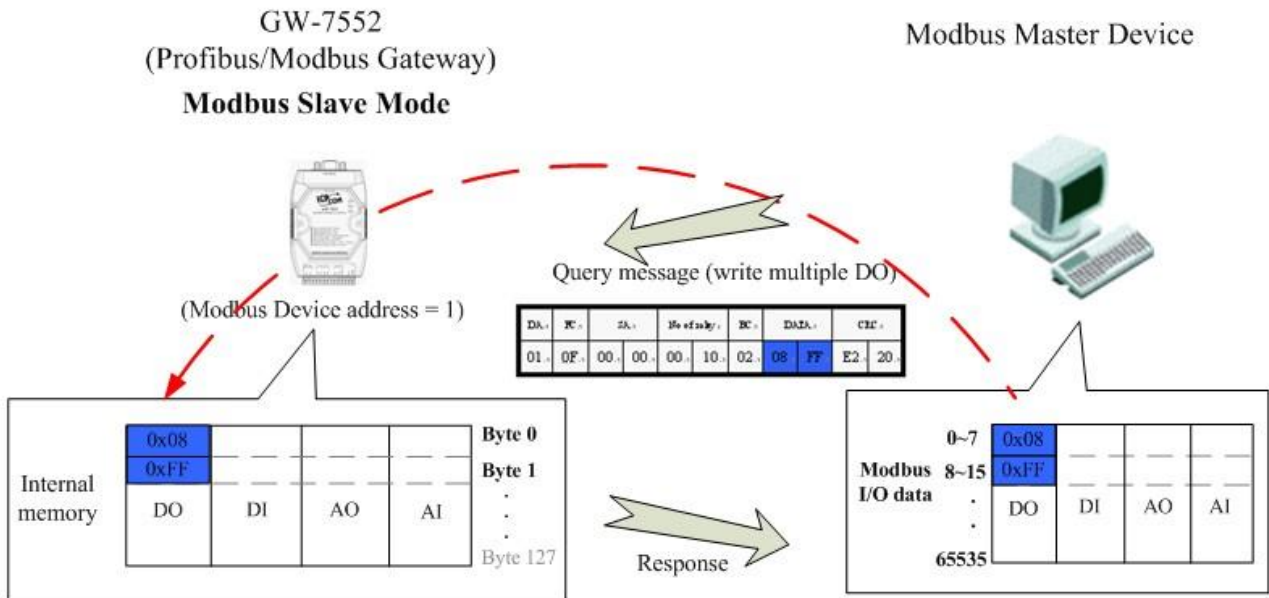

Figure 24 The GW-7552 receive data from Modbus master device

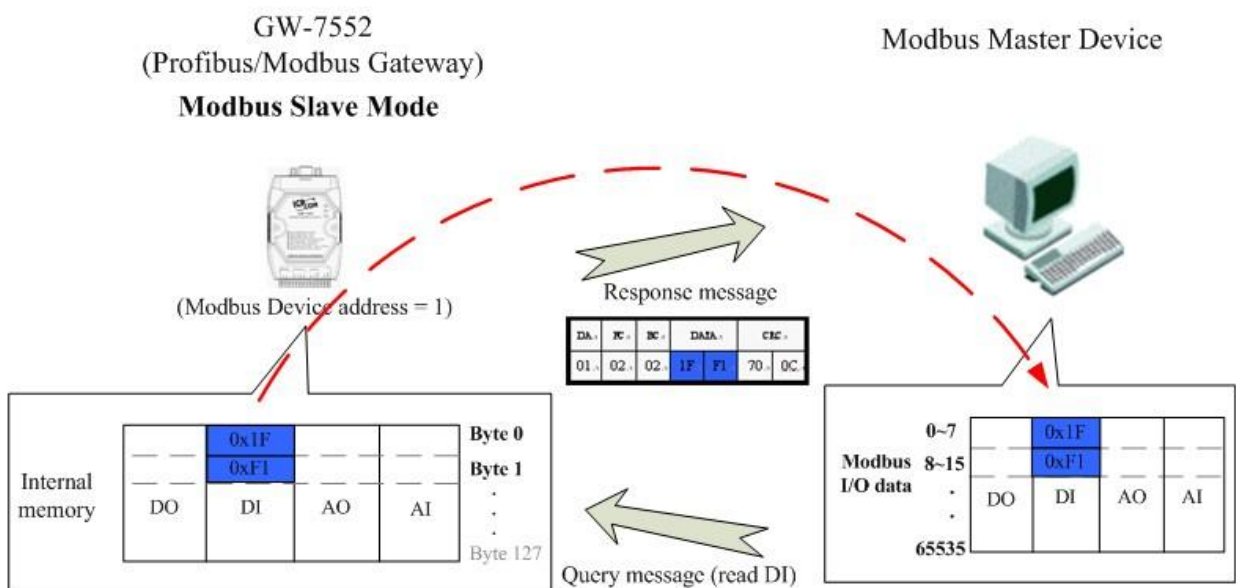

Figure 25 The GW-7552 output data to Modbus master device

3.3 Communication protocol transfer

In section 3.1 and 3.2, we can understand that data exchange is through DI、DO、AI、AO memory space of the GW-7552 between Profibus master、Modbus and the GW-7552. When the GW-7552 acts as a Modbus master device, the data exchange runs continuously between Profibus master、Modbus and the GW-7552, as shown in *figure 26、27*.

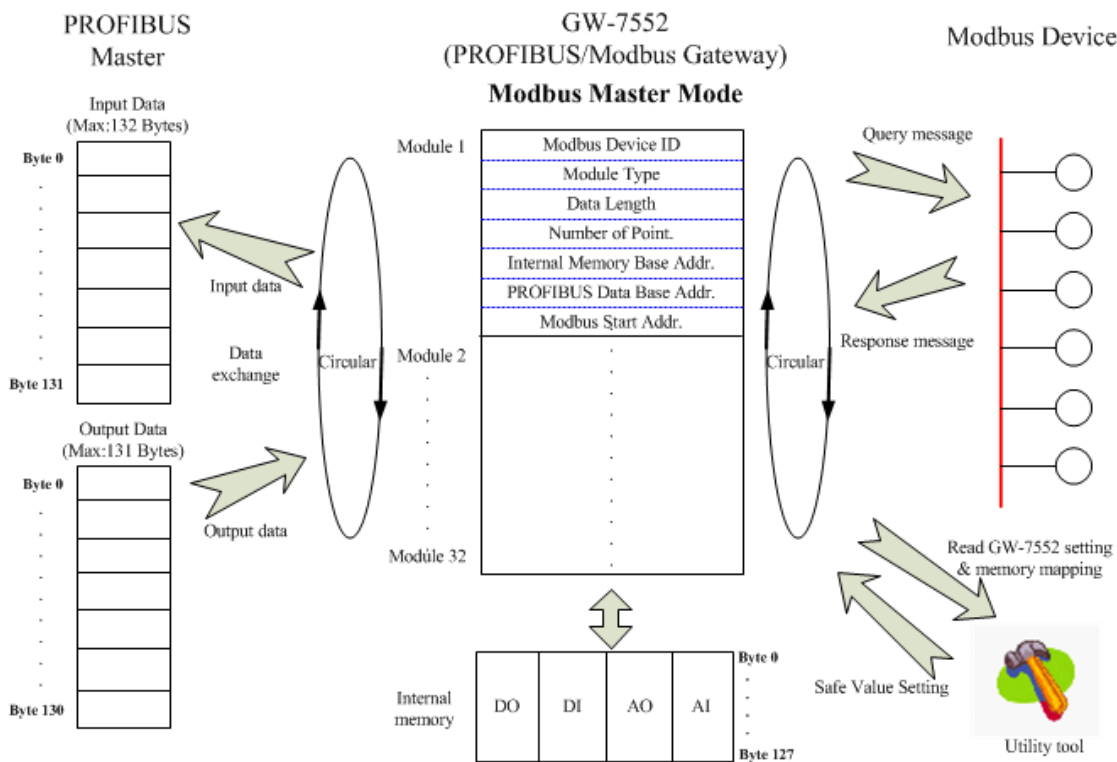

Figure 26 GW-7552 (master mode) communication protocol transfers

GW-7552 data exchange (master mode)

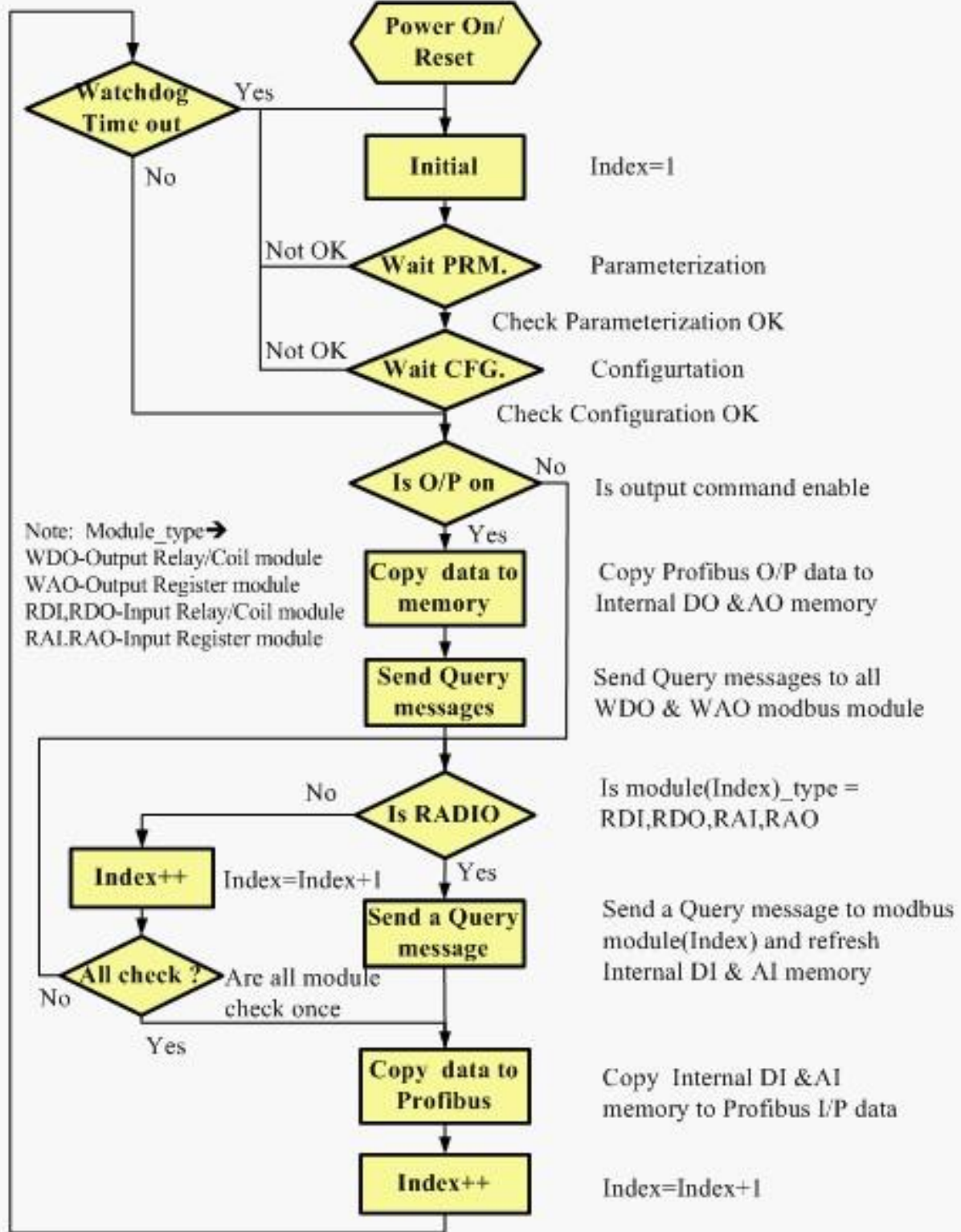

Figure 27 GW-7552 (master mode) flowchart

When the GW-7552 acts as a Modbus slave device, the data exchange runs continuously between Profibus master and the GW-7552 and the data exchange runs between Modbus master device and the GW-7552, when GW-7552 receive query message from Modbus master device, as shown in *figure 28* · 29.

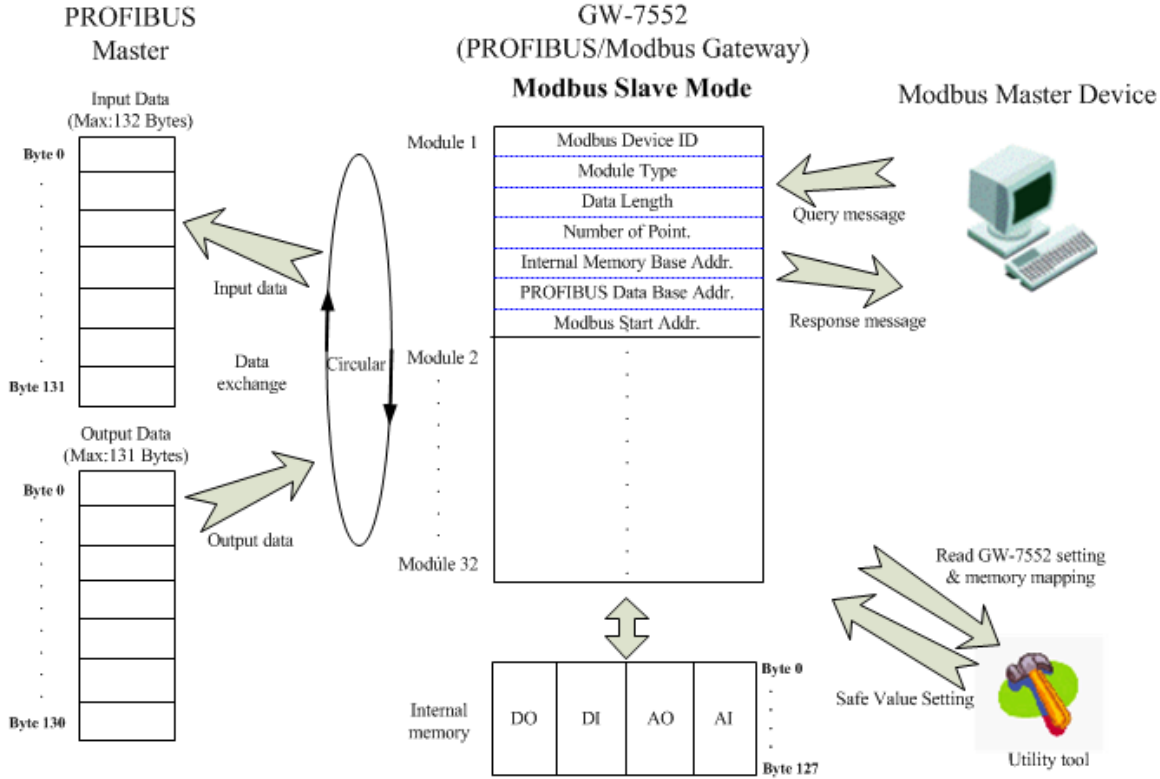

Figure 28 GW-7552 (slave mode) communication protocol transfer

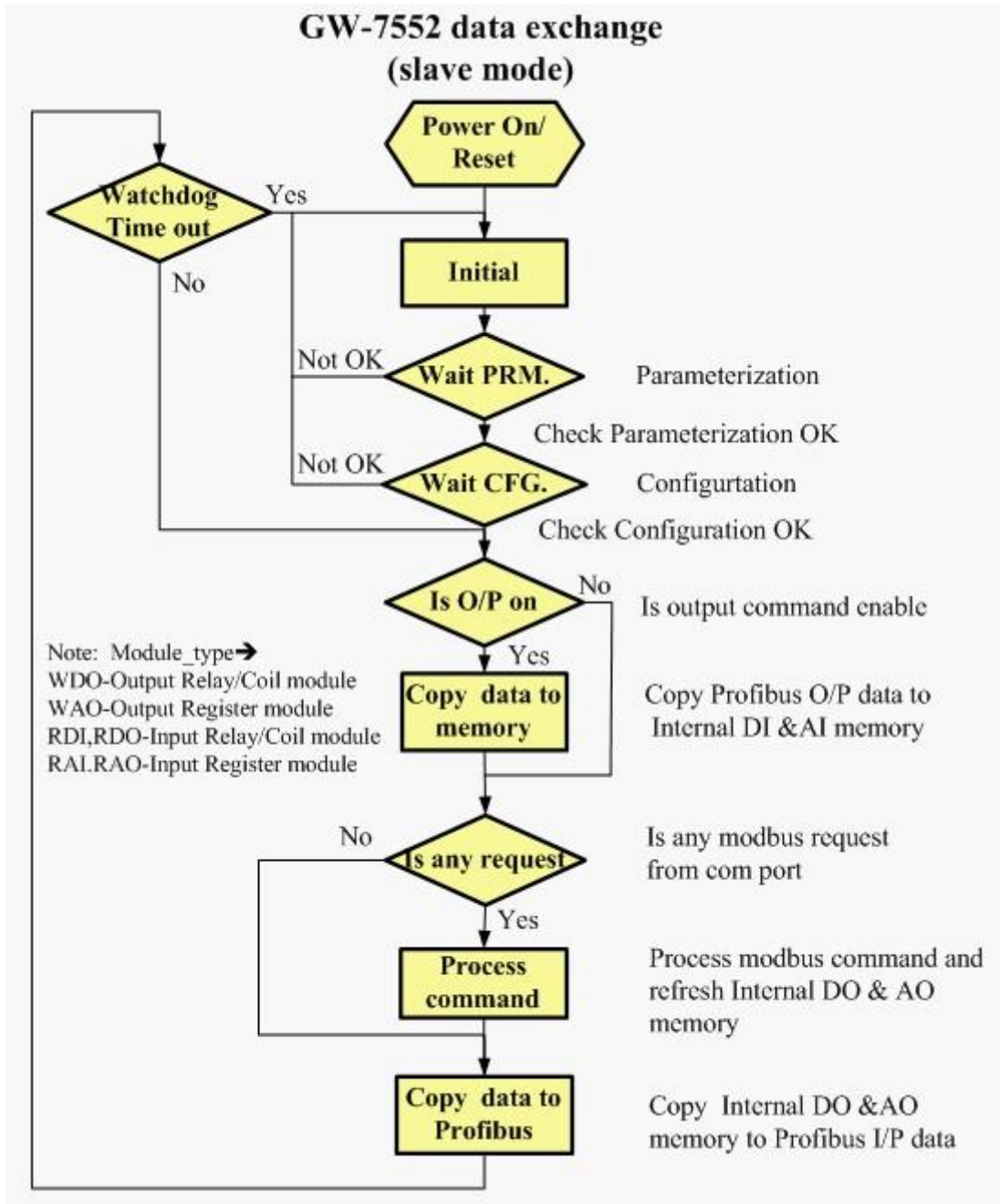

Figure 29 GW-7552 (slave mode) flowchart

4. Communication

4.1 Field of application

A master station can be a PLC, PC or any other smart device. The system can be a mono-master system (*Figure 30*) or a multi-master system (*Figure 31*). The GW-7552 enables the integration of the Modbus devices into a PROFIBUS DP network.

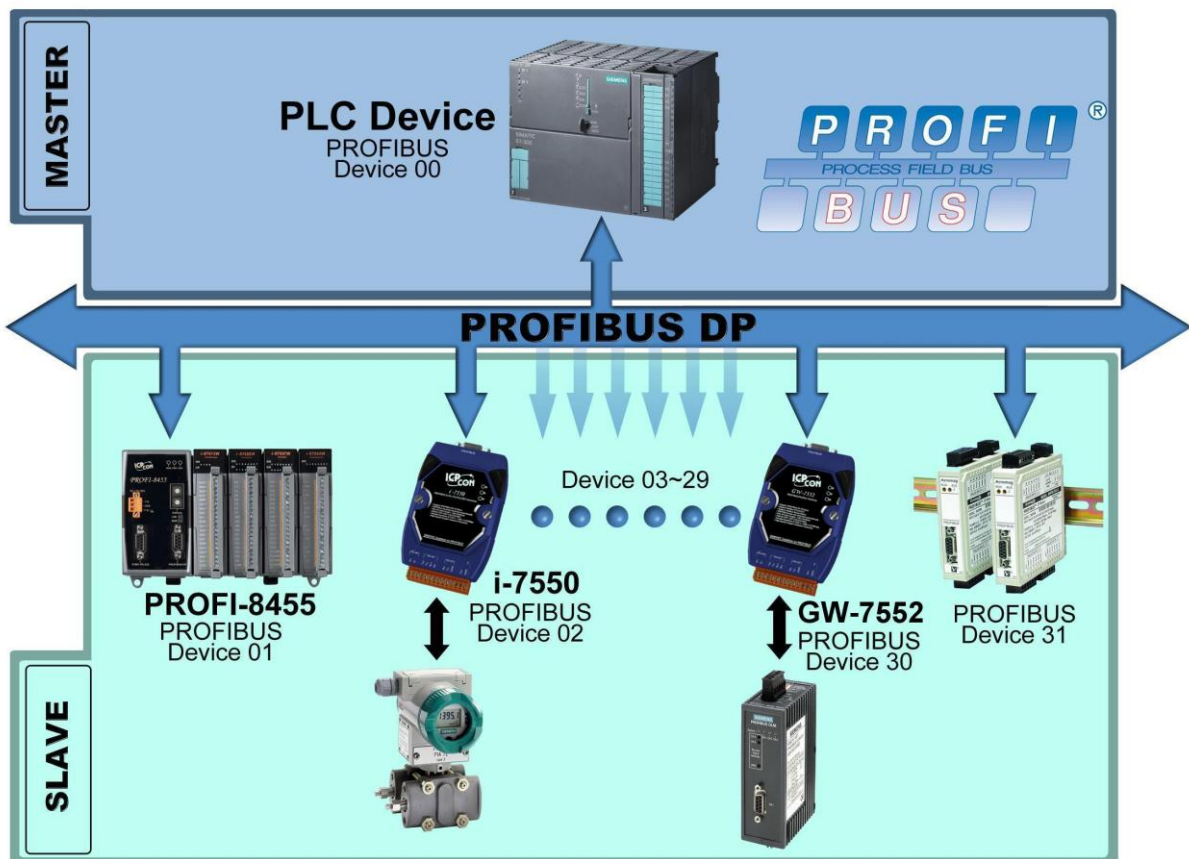

Figure 30 Mono-master system

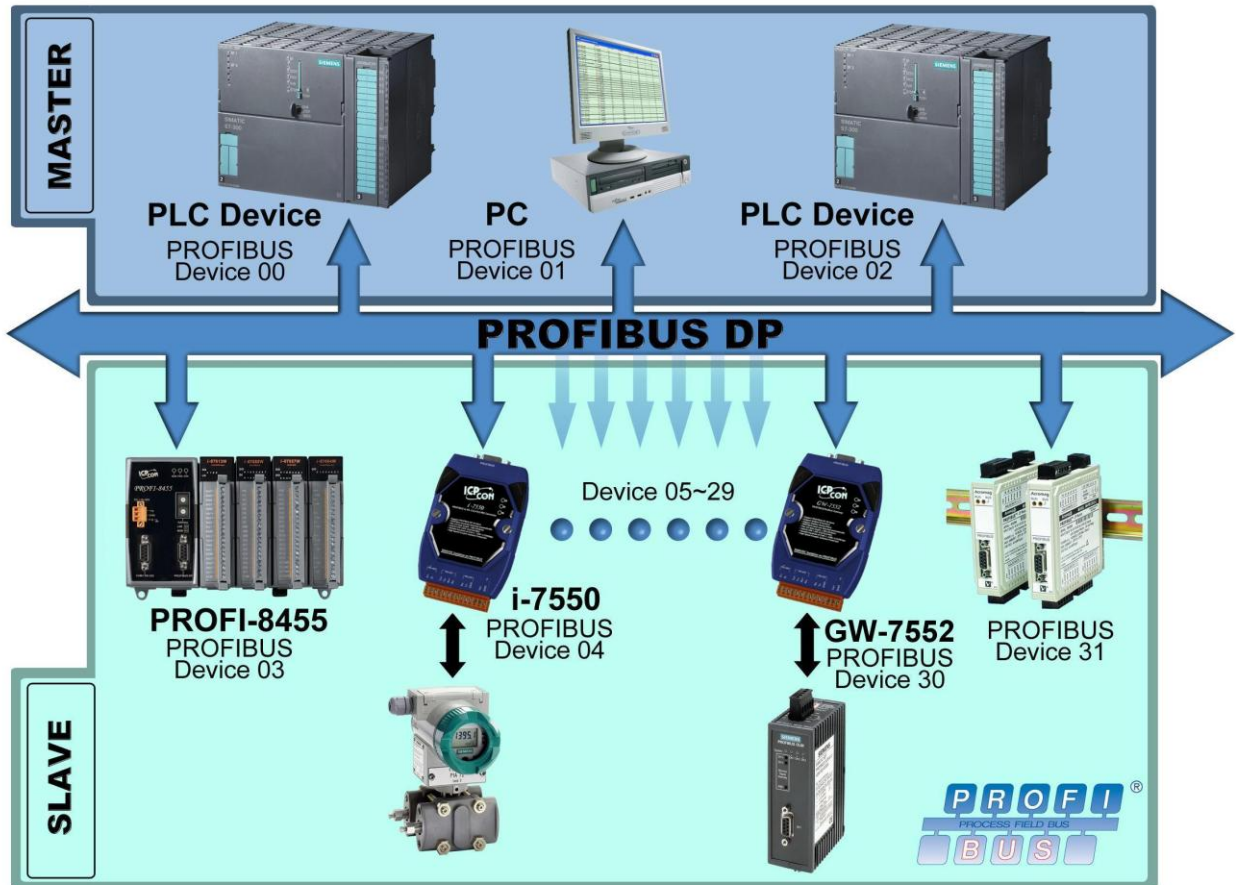

Figure 31 Multi-master system

4.2 GSD file

The characteristic (ex: baud rate, message length, number of input / output data.....) of each PROFIBUS DP device is described in the GSD file. The GSD file of the GW-7552 is in the ICP DAS companion CD-ROM (PATH--> CD: \PROFIBUS\GATEWAY\GW-7552\GSD\). The user can copy GSD file (IPDS0B87.gsd) and the Bitmap file (ICP_7552.bmp \ i_7552.bmp) to the PROFIBUS configuration tool.

4.2.1 The example of how to load GSD file

In the following examples the CIF50-PB PROFIBUS master card from Hilscher is used. The configuration and communication is done by the program “SyCon” provided by Hilscher.

Step 1: Copy the GSD file (IPDS0B87.gsd) and the Bitmap file (ICP_7552.bmp, i-7552.bmp) from CD of the GW-7552 module into the Profibus configuration tool.

File->CopyGSD

(Directory: --> CD: \PROFIBUS\GATEWAY\GW-7552\GSD\)

Step 2: Click “insert slave” button in the PROFIBUS configuration tool.

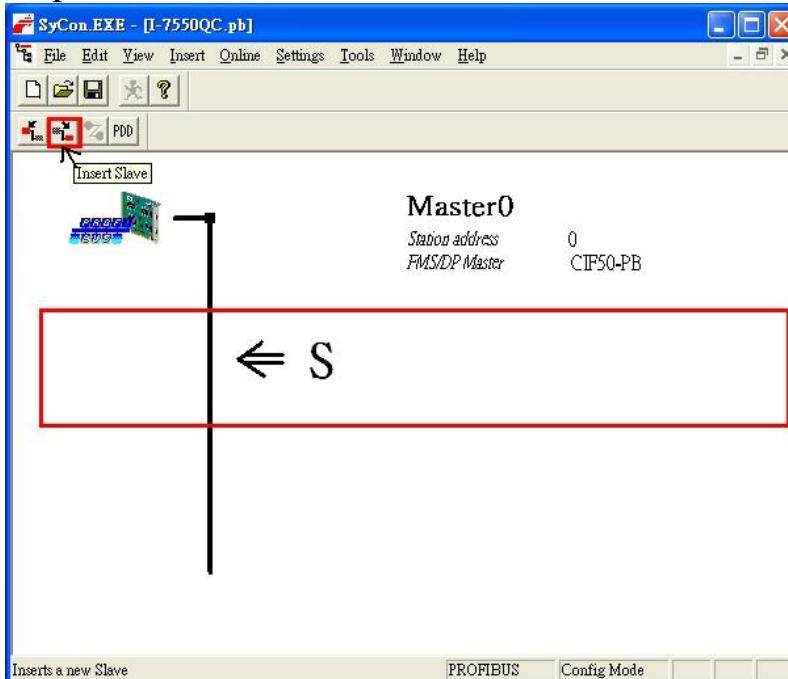

Figure 32 insert PROFIBUS slave device

Step 3: Select GW-7552 and click “Add” button to assign the GW-7552.

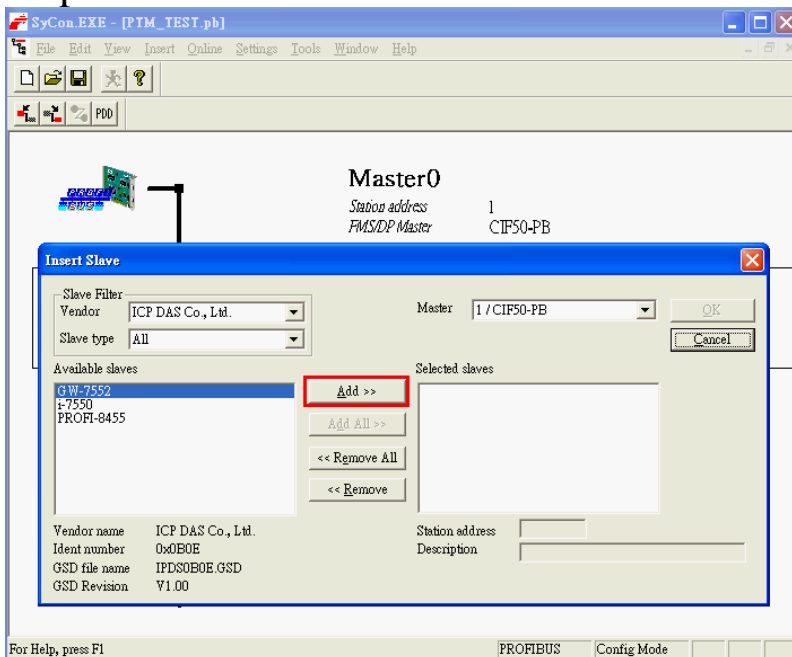

Figure 33 assign the GW-7552

Step 4: Set the address of the GW-7552 and click “OK” button.

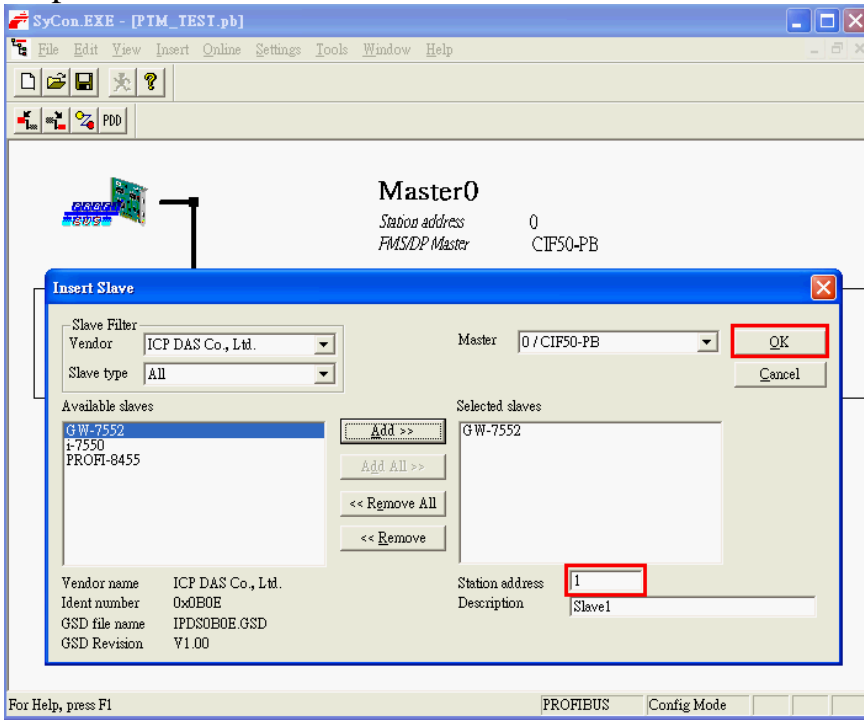

Figure 34 set the address of the GW-7552

Step 5: The GW-7552 icon is shown in the window. It adds the GW-7552 successfully in the software.

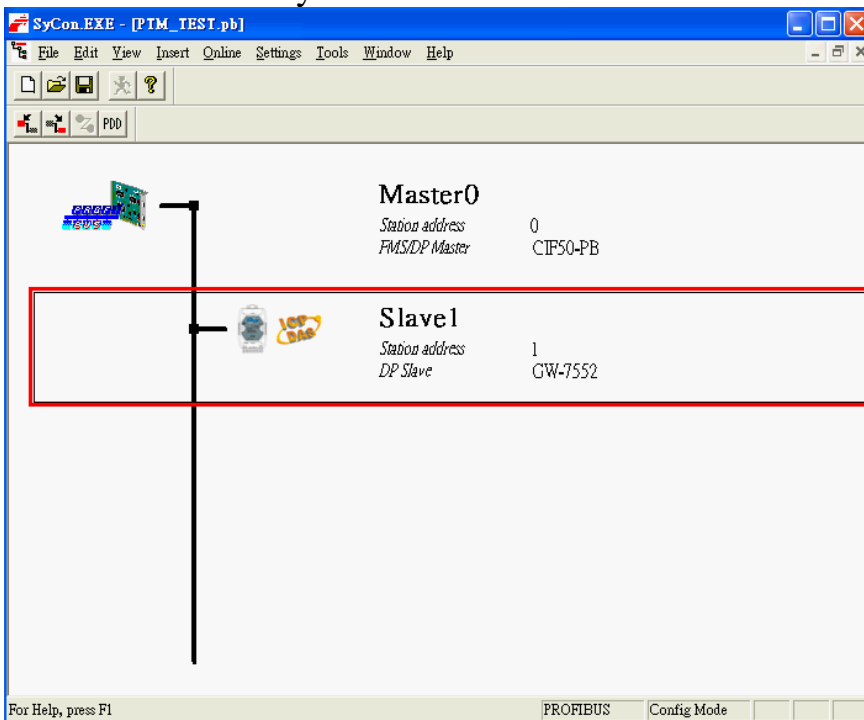

Figure 35 Finish adding the GW-7552

4.3 The Configuration of the common parameters

GW-7552 has eleven common parameters. The user can configure the common parameters to set the communication mode and data format by the PROFIBUS configuration tool. The common parameters are described below.

- COM Port baud rate : 2400/4800/9600/19200/38400/57600/115200
- COM Port parity : None/Even/Odd
- COM Port data length : 7/8 data bit
- COM Port stop bit : 1/2 stop bit
- Modbus Type : Master/Slave
- Modbus Format : RTU/ASCII
- I/O Safe Mode : Retain last value/Switch safe value
- Byte Order : Little-Endian/Big-Endian
- Output Data Mode : Manual/Auto
- Modbus Device ID(S) : 1~247
- Polling Modbus Device Interval(ms) (M) : 1~65535ms
- Query Message Timeout Value(ms)(M) : 1~65535ms

PS :

- a. When stop bit of Com Port is 2, data bit of Com Port must be 7 or else stop bit of Com Port will be set to 1.
- b. I/O Safe Mode

When GW-7552 acts as a Modbus master (Modbus Type=Master):

- i. *Data exchange between Profibus master and GW-7552 is interrupted*
“I/O Safe Mode” will be activated when the data exchange between Profibus master and GW-7552 is interrupted (e.g. no physical connection, Profibus master leaves the data exchange mode, etc.).
 - I/O safe mode = “Switch Safe Value”
The GW-7552 will set internal DIO and AIO data to safe value and send the safe values to the Modbus slave device.
 - I/O safe mode = “Retain Last Value”
Internal DIO and AIO data retain last value
- ii. *Connection between Modbus slave and the GW-7552 is interrupted*
 - I/O safe mode = “Switch Safe Value”
The GW-7552 will set the internal DI and AI data to safe value and send safe values to Profibus master device.
 - I/O safe mode = “Retain Last Value”
Internal DIO and AIO data retain last value

When GW-7552 acts as a Modbus slave (Modbus Type=Slave):

i. Data exchange between Profibus master and GW-7552 is interrupted
“I/O Safe Mode” will be activated when the data exchange between Profibus master and GW-7552 is interrupted.

- I/O safe mode = “Switch Safe Value”
The GW-7552 will set internal DIO and AIO data to safe value.
- I/O safe mode = “Retain Last Value”
Internal DIO and AIO data retain last value

ii. Connection between Modbus master and the GW-7552 is interrupted
Internal DIO and AIO data retain last value received

Please refer section 5.4 about the safe value settings

- c. Byte order is an important factor related to the memory allocation. Big-endian byte order (Motorola format) allocates more significant byte in lower memory address. On the other hand, little-endian byte order (Intel format) allocates more significant byte in higher memory address.
- d. When Output Data Mode is “Auto”, the GW-7552 will update the value of the output and input module automatically. When Output Data Mode is “Manual”, the GW-7553 will update the value of the input module automatically and the user must update manually the value of the output module (please refer to section 4.6.2 Data Output Command).
- e. Modbus device ID is a Modbus address of the GW-7552, when the GW-7552 acts as a Modbus slave device.
- f. We recommend the user to set the “query message timeout value” bigger than 3ms in order to identify the response message.
- g. (M) means the parameter is effective, when Modbus type of GW-7552 is master.
(S) means the parameter is effective, when Modbus type of GW-7552 is slave.

4.4 The Configuration of the modules

The user can set the number and size of the I/O modules in the PROFIBUS configuration tool. The settings of the modules are described below.

- Max. I/O modules : 32 modules
- System setting module : 3 byte output , 4 byte input
- Output module : Output Relay/Coil => 1~32 Bytes
Output Register => 1~64 Words
- Input module : Input Relay/Coil => 1~32 Bytes
Input Register => 1~64 Words
- Max. length of I/O data : 263 Bytes
- Output length : 0~131 Bytes
- Input length : 0~132 Bytes

The modules have module parameters about the communication settings. The module parameters are shown in the below :

A. Output Relay/Coil module parameters :

- Modbus Slave Device ID(M) : 0~247
- Start Address(M) : 0~65535
- NO. of Relay/Coil(M) : $8*(n-1)+1 \sim 8*n$ Bits
n=Module size/Byte

B. Output Register module parameters :

- Modbus Slave Device ID (M) : 0~247
- Start Address(M) : 0~65535
- Change Word Order : Enable/Disable (Even module only)

C. Input Relay/Coil module parameters :

- Modbus Slave Device ID (M) : 0~247
- Start Address(M) : 0~65535
- NO. of Relay/Coil(M) : $8*(n-1)+1 \sim 8*n$ Bits
- Module Type(M) : Read DI/DO
n=Module size/Byte

D. Input Register module parameters :

- Modbus Slave Device ID (M) : 0~247
- Start Address(M) : 0~65535
- Module Type(M) : Read AI/AO
- Change Word Order : Enable/Disable (Even module only)

Example 1:

If the user wants to read a Modbus digital input module (DI module), Device ID is 1, data address is 10010~10019, and data count is 10.

In this case, the user can select an “Input Relay/Coil=> 2 Bytes module”, module parameters are shown in the below:

Input Relay/Coil module parameters :

- Modbus Slave Device ID(M) : 1
- Start Address(M) : 9
- NO. Of Relay/Coil(M) : 10
- Module Type(M) : Read DI

Example 2:

If the user wants to write a Modbus analog output module (AO module), Device ID is 2, data address is 40001~ 40004 and data count is 4.

In this case, the user can select an “Output Register => 4 Words module”, module parameters are shown in the below:

Output Register module parameters :

- Modbus Slave Device ID(M) : 2
- Start Address(M) : 0
- Change Word Order : Disable

PS :

- a. Relay/Coil module is digital module (DI/DO module), the unit is Byte; Register module is analog module (AI/AO module), the unit is Word.
- b. Modbus Slave Device ID : It is a Modbus slave device address.
- c. Start Address : The GW-7552 and Modbus slave device exchange data from this starting address.
- d. NO. of Relay/Coil : It is data size that the GW-7552 and Modbus slave device exchange.
- e. Module Type : The user can select data type for data exchange by this setting.
 - Write DO(WDO)-- Write Digital Output
 - Write AO(WAO)-- Write Analog Output
 - Read DI(RDI)- Read Digital Input
 - Read DO(RDO)- Read Digital Output
 - Read AI(RAI)-Read Analog Input
 - Read AO(RAO)-Read Analog Output
- f. Change Word Order : When this setting is “Enable”, the GW-7552 will

- change the data between the high word and low word for reading easily.
- g. (M) means the parameter is effective, when Modbus type of GW-7552 is master.

4.5 Diagnostic messages

The GW-7552 can record maximally 10 diagnostic messages at the same time. If the number of the diagnostic messages is bigger than 10, the GW-7552 will not process other diagnostic message. The diagnostic messages have four types. They are “Module Error”, “System Setting Module Error”, “EEPROM Error” and “Input Data Error”. The diagnostic messages are shown in *table 12*.

Table 12 diagnostic messages

Messages	Description	Note
Module 1~32 Error * (0x01-0x20)	ILLEGAL FUNCTION!(0x01)	Please refer Modbus Exception Code definition for detail.
	ILLEGAL DATA ADDRESS!(0x02)	
	ILLEGAL DATA VALUE!(0x03)	
	SLAVE DEVICE FAILURE!(0x04)	
	ACKNOWLEDGE!(0x05)	
	SLAVE DEVICE BUSY!(0x06)	
	NEGATIVE ACKNOWLEDGE!(0x07)	
	MEMORY PARITY ERROR!(0x08)	
	MODBUS NOT DEFINED ERROR!(0x09)	
	GATEWAY PATH UNAVAILABLE!(0x0A)	
	DEVICE FAILED TO RESPOND!(0x0B)	
	CRC (LRC) Error!(0xFD)	
Response Message Timeout!(0xFE)		
System setting module Error(0x82)	Not find System setting module.(0x3D)	
	Position is not correct!(0x3E)	
EEPROM Error(0x81)	Read safe value error.(0xFB)	
Data Error(0x83)	Profibus master lose data .(0x3C)	
	Lose Profibus output data.(0x3F)	

* These error messages are not supported when the GW-7552 act as a Modbus slave.

PS:

Diagnostic messages will show in input data area of System setting module (Please refer to section 4.6.1).

Data Error :

a. GW-7552 acts as a Modbus master

If the polling speed between the GW-7552 device and the Modbus slave is faster than the data exchange rate between Profibus master and the GW-7552 then the Profibus master will not get all the data from the Modbus slave and therefore a diagnostic message (“Profibus lose input data”) will be send by the GW-7552 to the Profibus master

b. GW-7552 acts as a Modbus slave

If the GW-7552 receives more telegram from the Modbus master than it transmits to the Profibus master then a diagnostic message (“Profibus lose input data”) will be send by the GW-7552 to the Profibus master.

c. When the GW-7552 receives a “data output command” (output byte 0) from system setting module, and this command didn’t increased in order (ex: 0->1, 1->2,..., 255->0), the GW-7552 will think that it lose some output data of the Profibus master and a diagnostic message (“Lose Profibus output data”) will be send by the GW-7552 to the Profibus master.

4.6 I/O data exchange

The I/O data exchange is decided by Modbus type of the GW-7552 (please refer section 4.3 The Configuration of the common parameters) between Profibus master device and the GW-7552. Output data area of Profibus master device is mapped into DO/AO memory of the GW-7552 and input data area of Profibus master device is mapped into DI/AI memory of the GW-7552, when Modbus type is master. In the other way, Output data area of Profibus master device is mapped into DI/AI memory of GW-7552 and input data area of Profibus master device is mapped into DO/AO memory of GW-7552, when Modbus type is slave (please refer section 3.1 Profibus data exchange).

4.6.1 Input data area

The maximum length of input data is 132 bytes. Before arrange the input module, the user must arrange and configure the system setting module. The first four bytes belong to diagnostic message, as shown in *table 13* The user can get data and control I/O of Modbus slave device or get DI/DO/AI/AO of the GW-7552 by read input module.

Table 13 Input data area

Module	Byte	Data	Description
System setting module (diagnostic message)	0		The number of Diagnostic messages
	1	00or03	Fixed value(The value is00 when byte 0 is 0, The value is03 when byte 0 is not 0)
	2		Message(refer table 12)
	3		Description(refer table 12)
Input module	4~131	Data	Receive data

EX. Input data area in byte 0 ~ byte3 information is “04 03 02 FE” ,
 ”04” means there are 4 diagnostic messages,
 “02” means “Module 2 error!”
 “FE” means “Response Message Timeout!”

4.6.2 Output data area and communication command

The maximum length of output data is 131 bytes. Before arrange the output module, the user must arrange and configure the system setting module. The first three bytes belong to communication commands, as shown in *table 14*. The user can change data and I/O state of Modbus slave device or DI/DO/AI/AO data of GW-7552 by modify data of output module.

Table 14 Output data area

Module	Byte	Bit Position								Description
		7	6	5	4	3	2	1	0	
System setting module	0									Data output command
	1	-	-	-	-	-	-	SM	DC	Control bit
	2									Output module select
Output module	3~130									Output data

- Data output command(byte 0)
 - a. When Modbus type is master

When this byte is changed, Profibus master device will send data of output module to DO/AO data of GW-7552 and then GW-7552 will send query message to Modbus slave device for change data or output state of Modbus slave device.
 - b. When Modbus type is slave

When this byte is changed, Profibus master device will send data of output module to DO/AO data of GW-7552.

PS: When the user use this byte to trigger “data output command”, the user must increase this byte in order (ex: 0->1, 1->2,..., 255->0) or else the GW-7552 will send a diagnostic message to the Profibus master (please refer section 4.5 Diagnostic messages).

- Control bit(byte 1)

DC(bit 0) : When this bit is set (DC=1), diagnostic messages send by the GW-7552 module will all be cleared.

SM(bit 1) : When this bit is set (SM=1), the GW-7552 will enter setup mode. The utility can communicate with the GW-7552 in this mode.

When this bit is "0" (SM=0), the GW-7552 will enter normal operation mode. The GW-7552 can communicate with Modbus device in this mode.

Bit 2~7 : The remaining bits have to be set to zero.

- Output module select(byte 2)

When this byte is ‘0’ and the user change data output command(byte 0), it will trigger all data output command of output modules.

When this byte isn’t ‘0’ and the user change data output command(byte 0), it will trigger single data output command of the output module and this byte represent module address of the output module (ex: “byte 2”=3, it represent that the user want to trigger data output command of the third module)

4.7 Establish connection with GW-7552

Before establishing a connection between the DP-Master and the GW-7552, user should execute the following steps first.

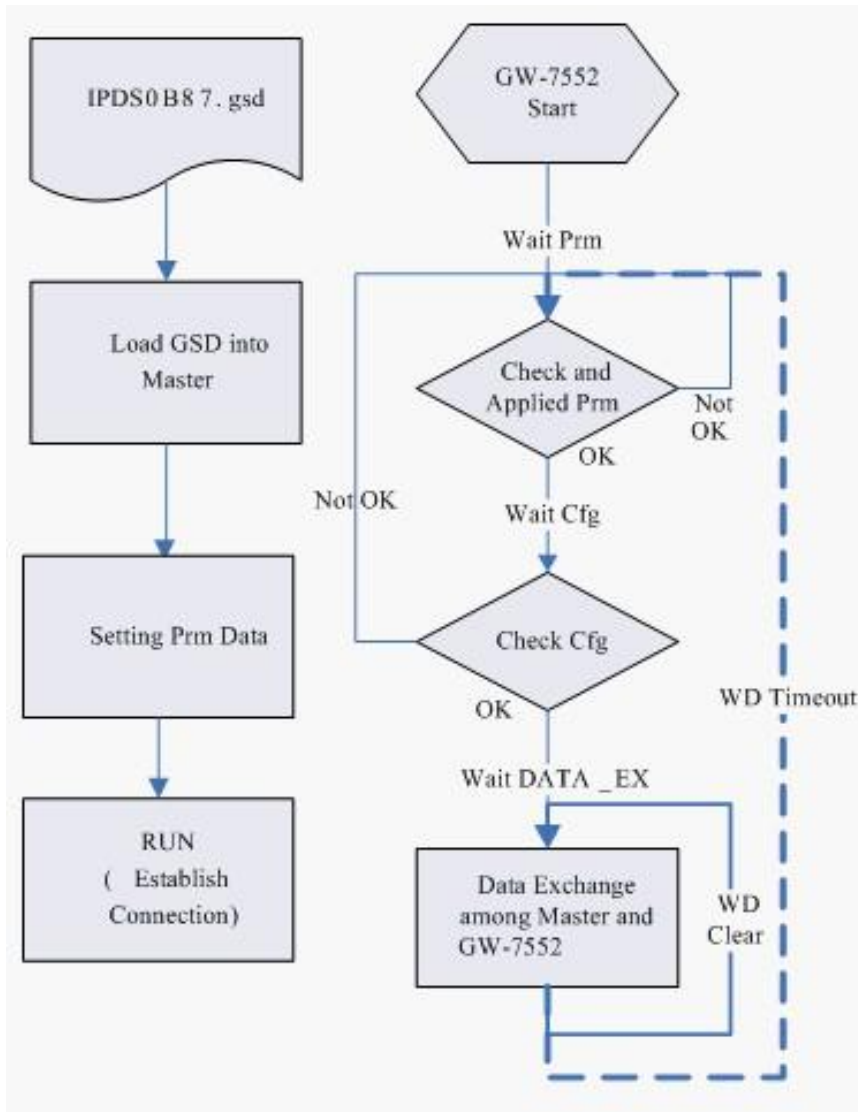

Figure 36 Establish connection with GW-7552

First, users must load the electronic device description file (GSD file) of the GW-7552 into the DP-Master, and then set the parameters. Finally change your DP-master from Offline state to Operate state. While DP-Master changes to operate mode, GW-7552 will initial the modules. Then GW-7552 allocates the memory space and waits for Set_Prm telegram. The next step is waiting for Check_Cfg telegram in order. If there is no error occurs, GW-7552 proceeds into data exchange state. Users can observe the status indicator LED to know the state of GW-7552. At the meantime, if there is any error occurs, GW-7552 will return to wait parameterization.

4.8 Data exchange example

In this example a Modbus master device simulated by a PC program sends query

message and receives response message from a Profibus master via the GW-7552 gateway.

In the following examples the CIF50-PB PROFIBUS master card from Hilscher is used. The configuration and communication is done by the program “SyCon” provided by Hilscher.

- Step 1: Copy the GSD file and assign the GW-7552 a valid station address (Please refer to the section 4.2 GSD file).
- Step 2: Connect the RS232 port of the GW-7552 module to a COM port of the PC and the Profibus port to a Profibus master (*Figure 37*).

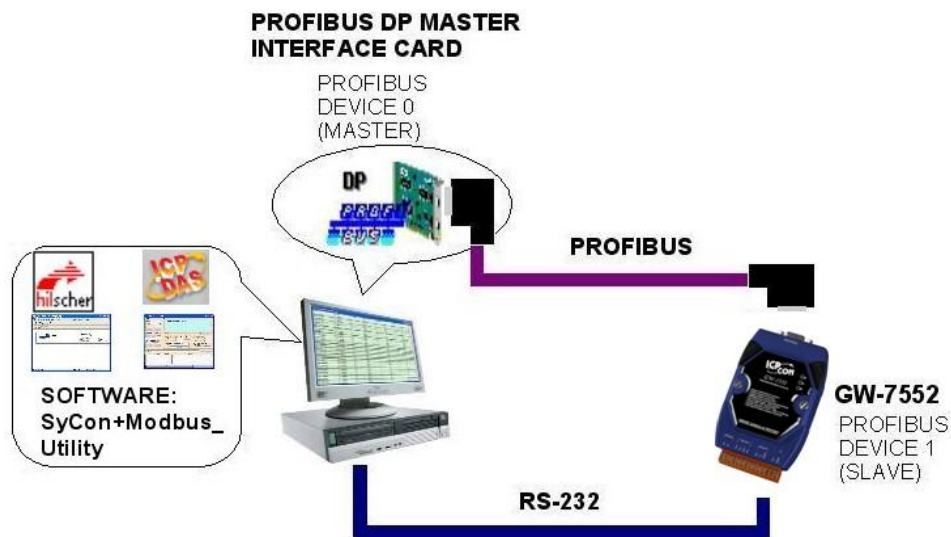

Figure 37 Wiring diagram between PC and GW-7552

- Step 3: Set the parameters of the GW-7552. We just need to change “Modbus type” to slave and the default setting is being used in the other parameters for this example. Please refer to section 4.3 the Configuration of the common parameters. The users can set parameters as shown in the below.

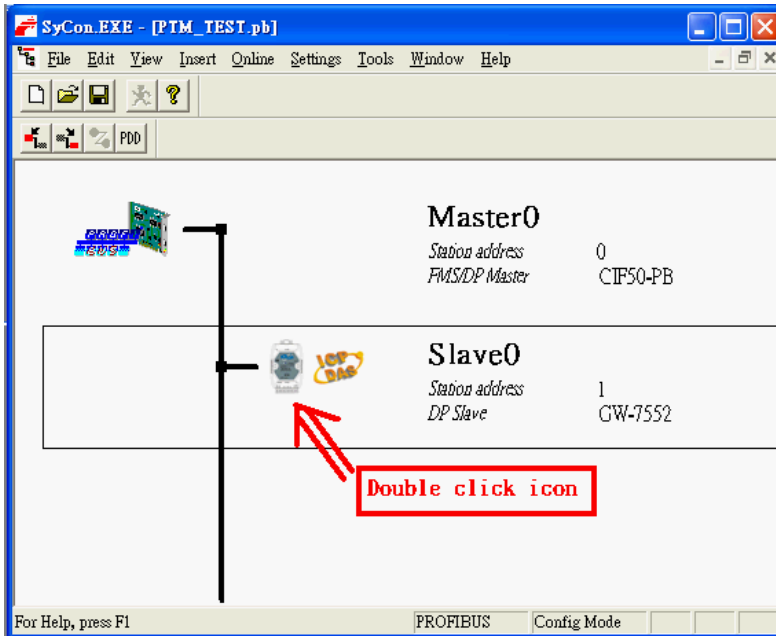

Figure 38 Double click the GW-7552 icon to open the "Slave configuration" window

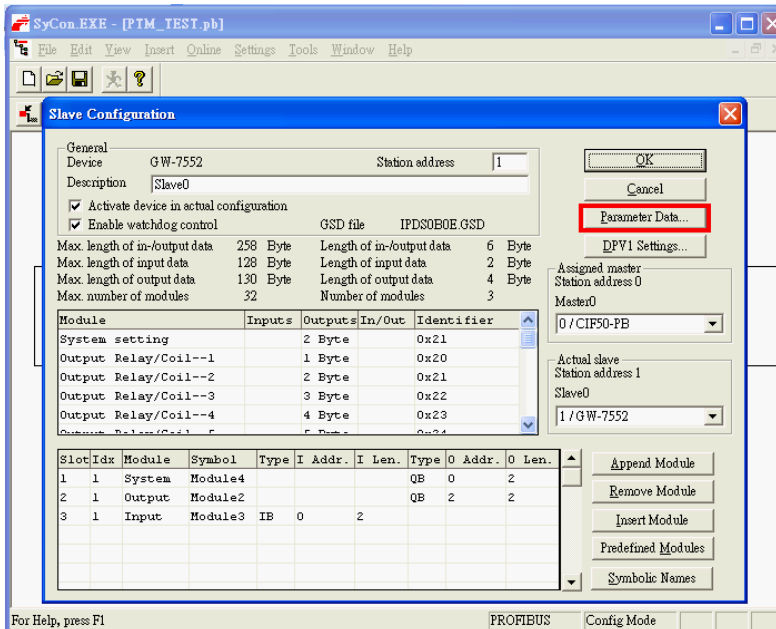

Figure 39 Click "Parameter Data..." button to open the "Parameter Data" window

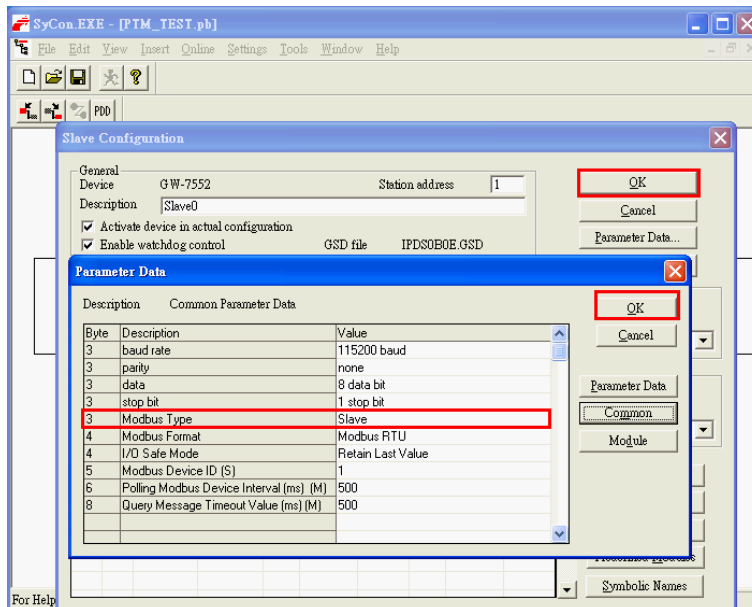

Figure 40 The user needs to change “Modbus type” to slave for this example and click “OK” button

Step 4: Set the GW-7552 modules, as shown in figure 41 and 42.

- Select “System setting” module: “System setting” module always has to be selected otherwise no communication can be established between the gateway and the Modbus network.
- Select “Output Relay/Coil” module: In this example a “Output Relay/Coil--2 Byte” module is selected.
- Select “Input Relay/Coil” module: In this example a “Input Relay/Coil--2 Byte” module is selected.

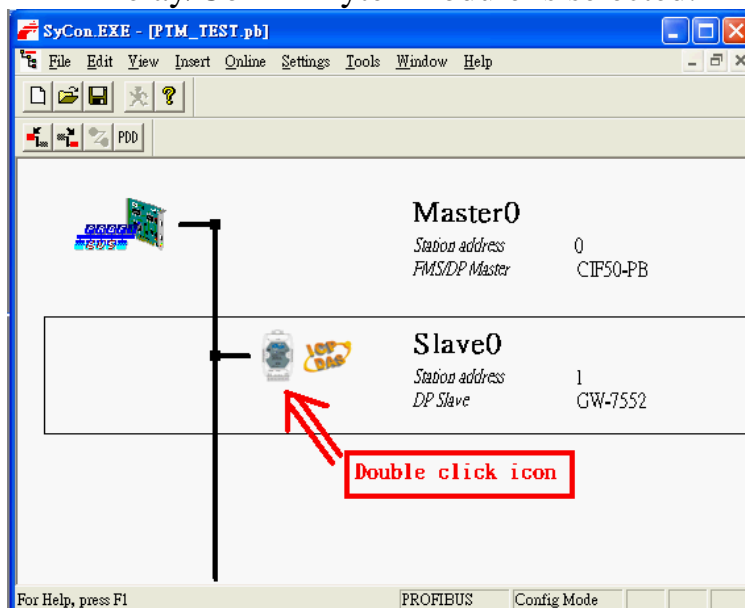

Figure 41 Double click the GW-7552 icon to open the “Slave configuration” window

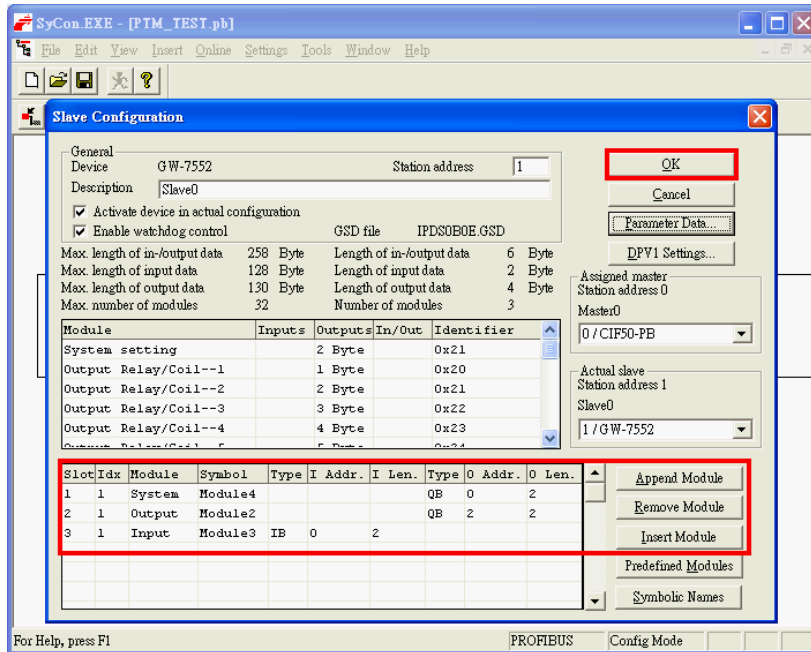

Figure 42 Select modules

Step 5: Close the “Slave Configuration” window by clicking the “OK” button.

Step 6: Now the setting done by the configuration tool has to be downloaded to the Profibus master.

Click on the master area in the graphic window then
Online -> Download...

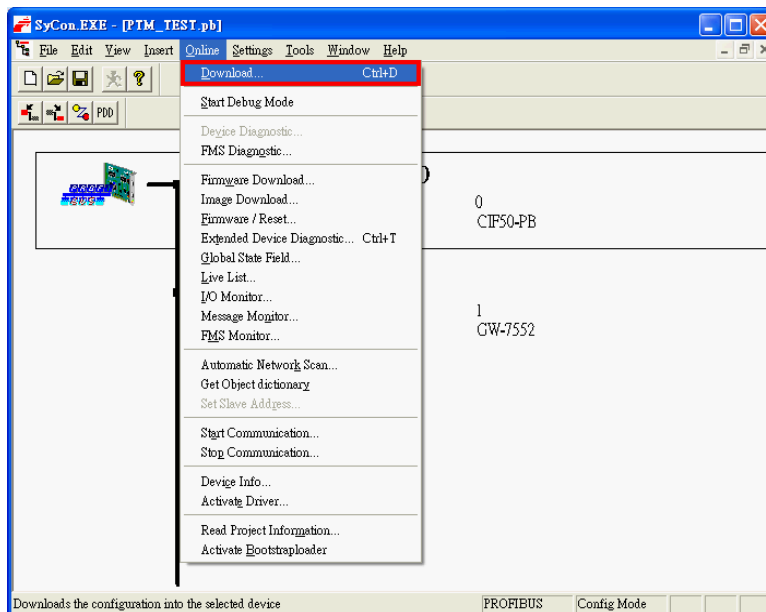

Figure 43 Click “Online->Download” to download the setting into PROFIBUS master

4.8.1 Receiving data from a Modbus master device

-- Start the test utility “MBRTU” (figure 44) on the PC.

This utility simulates a Modbus master device and is on the web site in the following directory:

http://ftp.icpdas.com.tw/pub/cd/8000cd/napdos/modbus/modbus_utility/

- (1) Set the COM port number of the PC
- (2) Set the Baud rate to 115200
- (3) Set the Line control to N,8,1
- (4) Open the connection

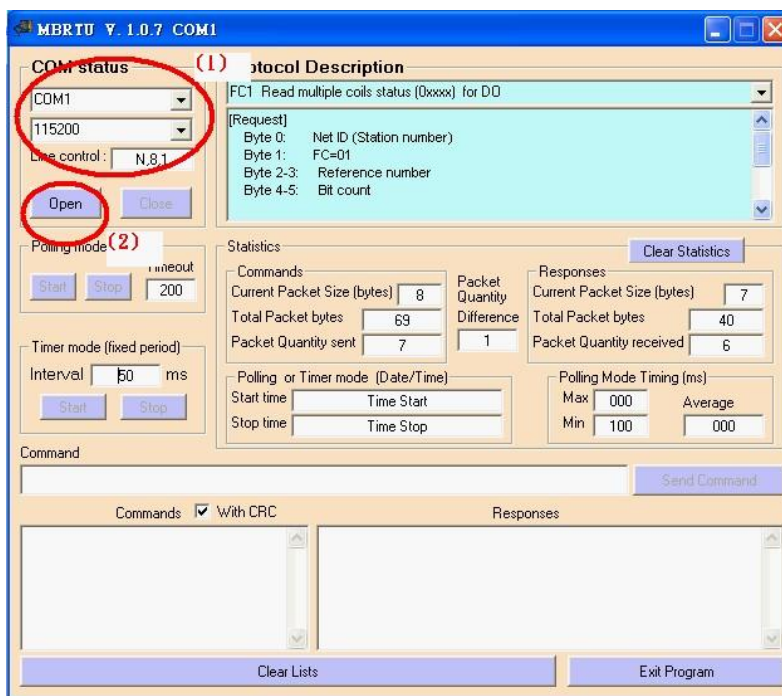

Figure 44 MBRTU Utility

--Send Command to write DO of the GW-7552

The user needs to input command (“01 0F 00 00 00 10 02 FF FF”) here and click <Send Command> button to send Modbus command: “01 0F 00 00 00 10 02 FF FF E3 90” and then MBRTU can receive response message (“01 0F 00 00 00 10 54 07”). The user can find byte 4, 5 of the input data area in the configuration program “SyCon” have changed into “FF” at this time, as shown in the below.

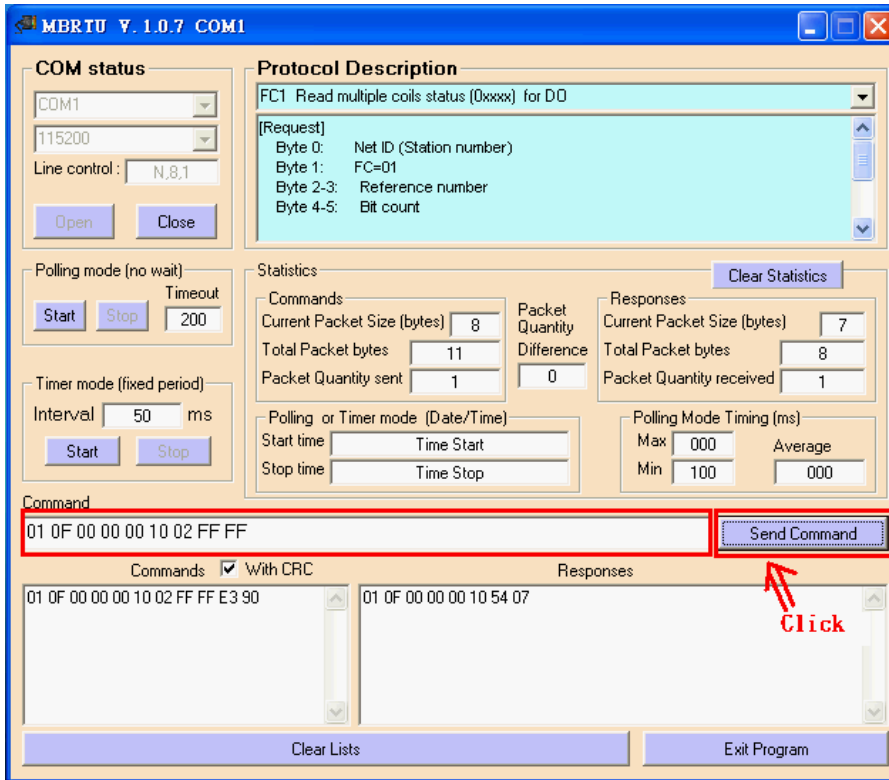

Figure 45 Send Modbus command (output data: FF, FF)

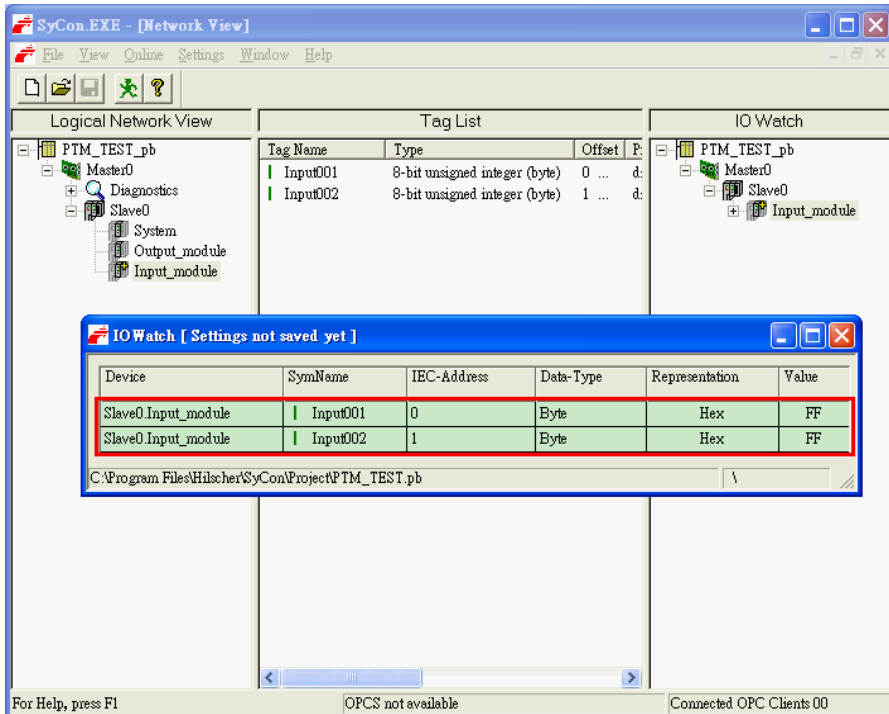

Figure 46 Receive "0xFF" in the input data area

Table 15 Receive “0xFF” in the input data area

Module	Byte	Data type	Representation	Value
Input module	Input 4	Byte	Hex	0xFF
	Input 5	Byte	Hex	0xFF

PS:

Modbus command:

Query message

DA	FC	SA (Hi)	SA (Lo)	NO (Hi)	NO (Lo)	BC	DATA		CRC check	
01	0F	00	00	00	10	02	FF	FF	E3	90

Response message

DA	FC	SA (Hi)	SA (Lo)	NO (Hi)	NO (Lo)	CRC check	
01	0F	00	00	00	10	54	07

- DA: Device Address-0x01
- FC: Function Code-0x0F=>Write multi-DO
- SA(Hi): Start Address(Hi byte)-0x00
- SA(Lo): Start Address(Lo byte)-0x00
- NO(Hi): No. Of points (Hi byte)-0x00
- NO(Lo): No. Of points (Lo byte)-0x10
- BC: Byte Count-0x02

4.8.2 Receiving data from the Profibus master device

--Send Command to read DI of the GW-7552

The user needs to input command (“ 01 02 00 00 00 10”) in MBRTU and click <Send Command> button to send Modbus command: “01 02 00 00 00 10 79 C6” and then MBRTU can receive response message (“ 01 02 02 00 00

B9 B8”). In this message, the user can know the value of DI0 & DI1 is “0” in the GW-7552.

--Send output data to write DI of the GW-7552 by the Profibus master
 The user needs to set “0xFE” & “0xDC” in byte 3 & byte 4 of output data area in the configuration program “SyCon” and then set the value of the first byte from 0 to 1 to trigger the data output command.

--Send Command to read DI of the GW-7552 again
 Now the user can input command (“ 01 02 00 00 00 10”) in MBRTU and click <Send Command> button to send Modbus command: “01 02 00 00 00 10 79 C6” again. Then MBRTU can receive response message (“ 01 02 02 FE DC F8 41”). In this message, the user can know the value of DI0 & DI1 have changed into “0xFE” & “0xDC” in the GW-7552, as shown in *figure 47, 48, 49 & table 16*.

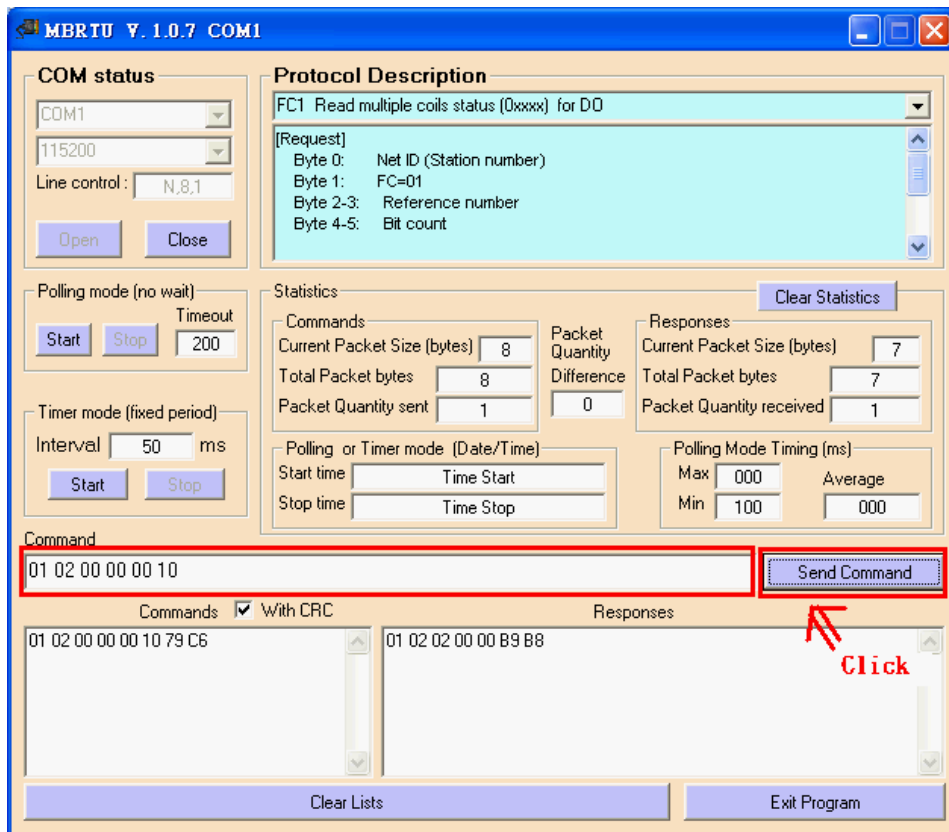

Figure 47 Send Modbus command to read DI of the GW-7552

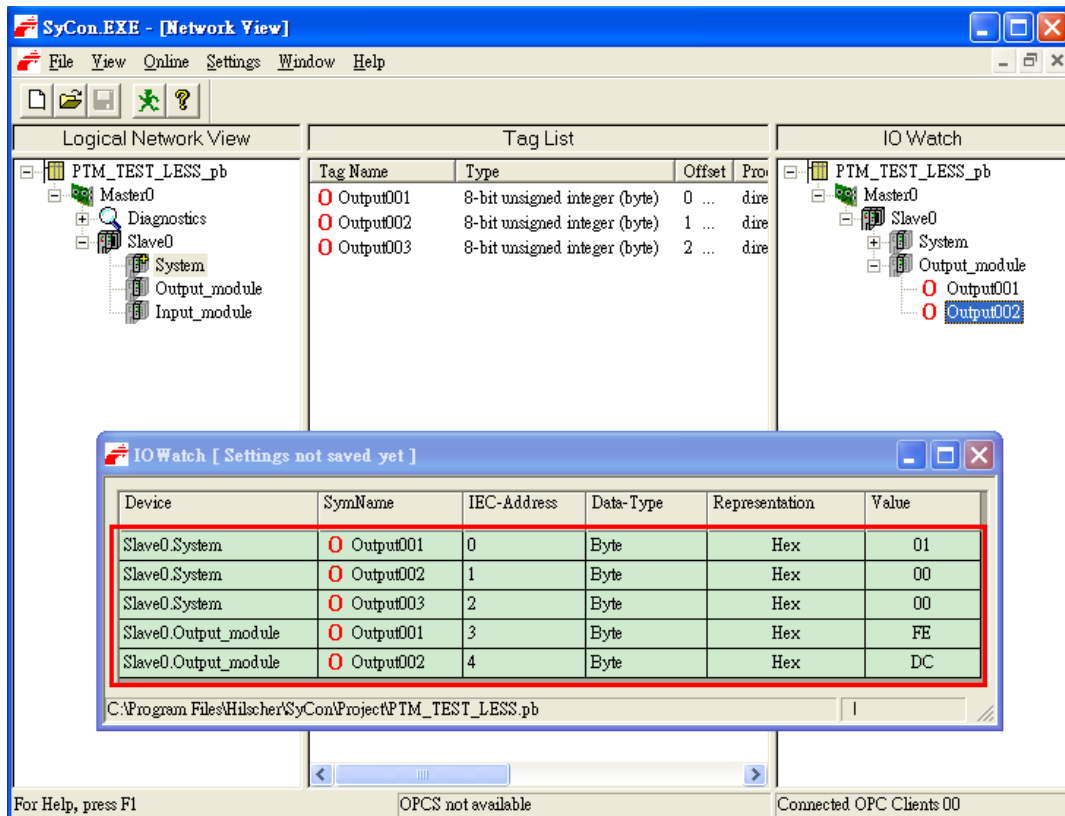

Figure48 Set output data and trigger output data command in the output data area

Table 16 Set output data and trigger output data command

Module	Byte	Data type	Representation	Value
System module	Output 0	Byte	Hex	0x00 → 0x01
	Output 1	Byte	Hex	0x00
	Output 2	Byte	Hex	0x00
Output module	Output 3	Byte	Hex	0x00 → 0xFE
	Output 4	Byte	Hex	0x00 → 0xDC

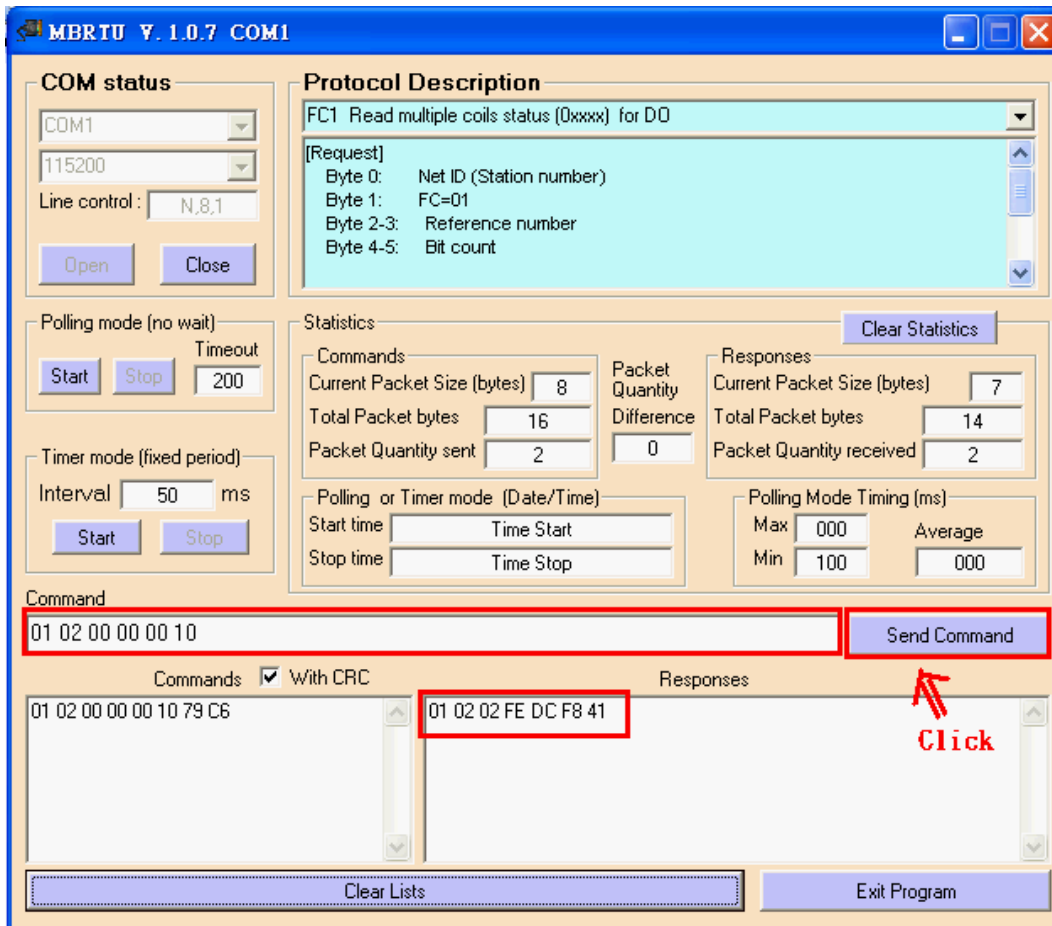

Figure 49 Send Modbus command to read DI of the GW-7552 and receive data (0xFE, 0xDC)

PS:

Modbus command:

Query message

DA	FC	SA (Hi)	SA (Lo)	NO (Hi)	NO (Lo)	CRC check	
01	02	00	00	00	10	79	C6

Response message

DA	FC	BC	DATA		CRC check	
01	02	02	FE	DC	F8	41

- DA: Device Address-0x01
- FC: Function Code-0x02:read DI
- SA(Hi): Start Address(Hi byte)-0x00
- SA(Lo): Start Address(Lo byte)-0x00
- NO(Hi): No. Of points(Hi byte)-0x00
- NO(Lo): No. Of points (Lo byte)-0x10
- BC: Byte Count-0x02

5. Application of Utility

5.1 Install Utility

Step 1 :

Download the Profibus/Modbus gateway utility setup file from the CD-ROM disk following the path of “CD:profibus\gateway\gw-7552\utilities\” or the web site

“ftp://ftp.icpdas.com.tw/pub/cd/fieldbus_cd/profibus/gateway/gw-7552/utilities/”

Step 2 :

Execute the Setup.exe file to install the Profibus/Modbus Gateway Utility.

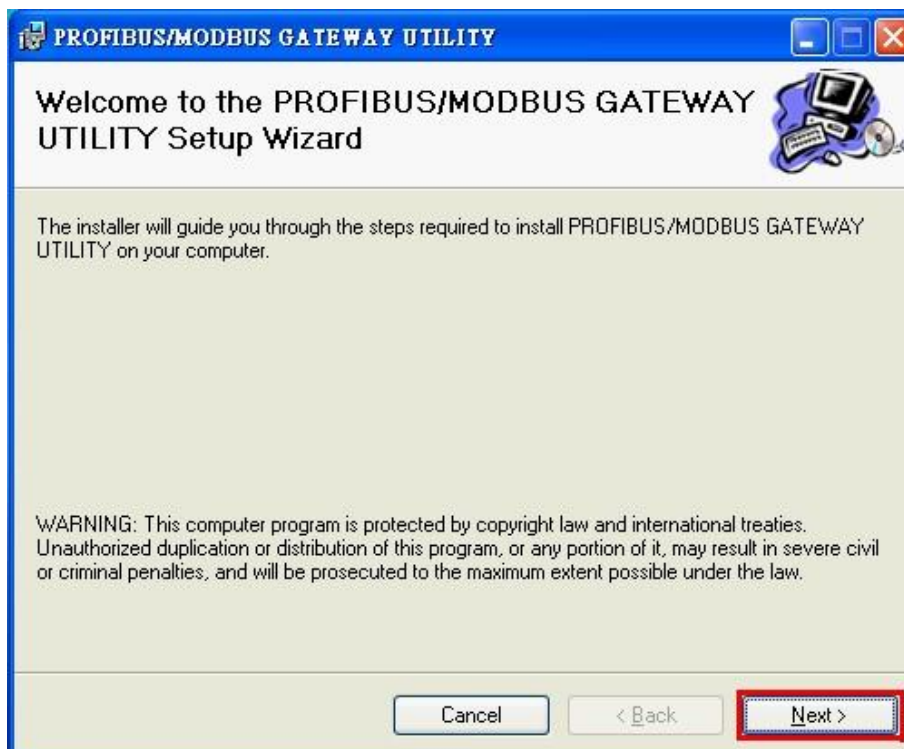

Figure 50 install the utility

Step 3 :

Click the “Next” button to continue. If you want to change the installation destination, click “Browse” button to set the installation path.

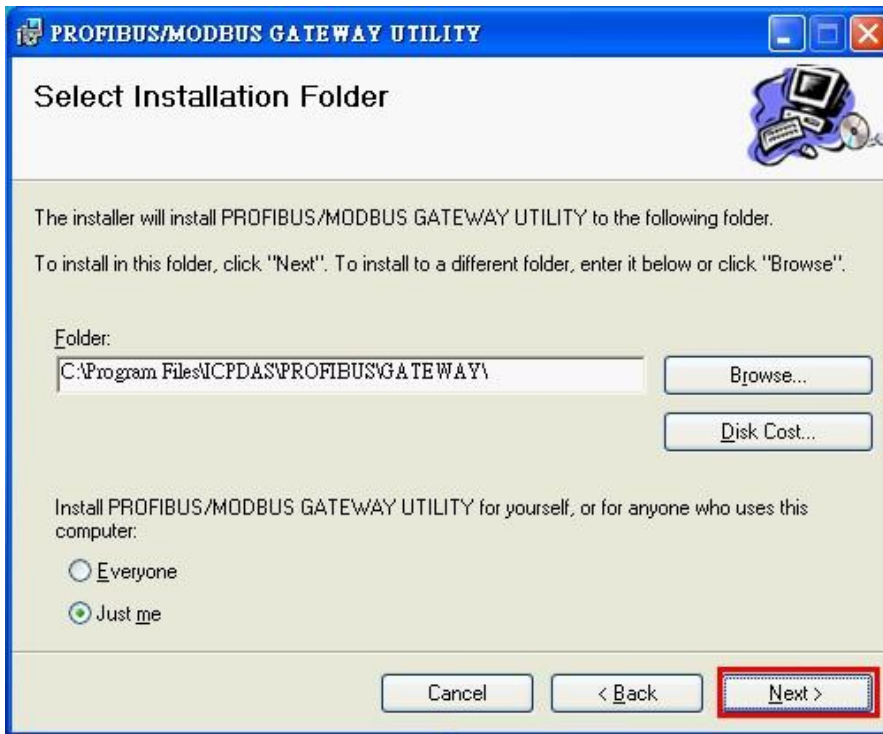

Figure 51 set the installation path

Step 4 :

Click the “Next” button to confirm installation

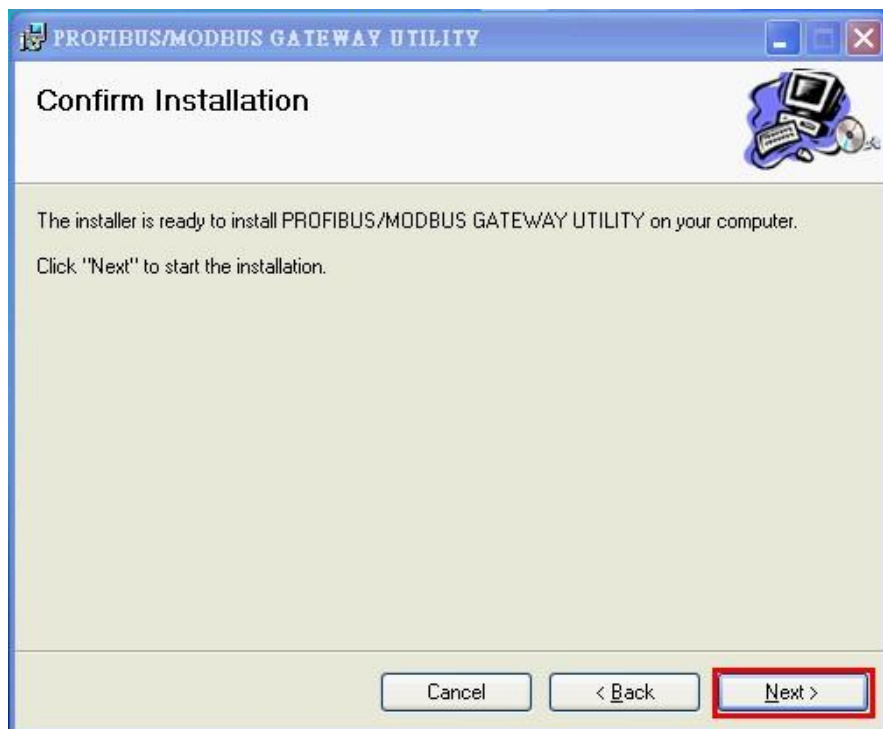

Figure 52 Confirm installation

Step 5 :

Click the “Close” button to finish and exit the installation program

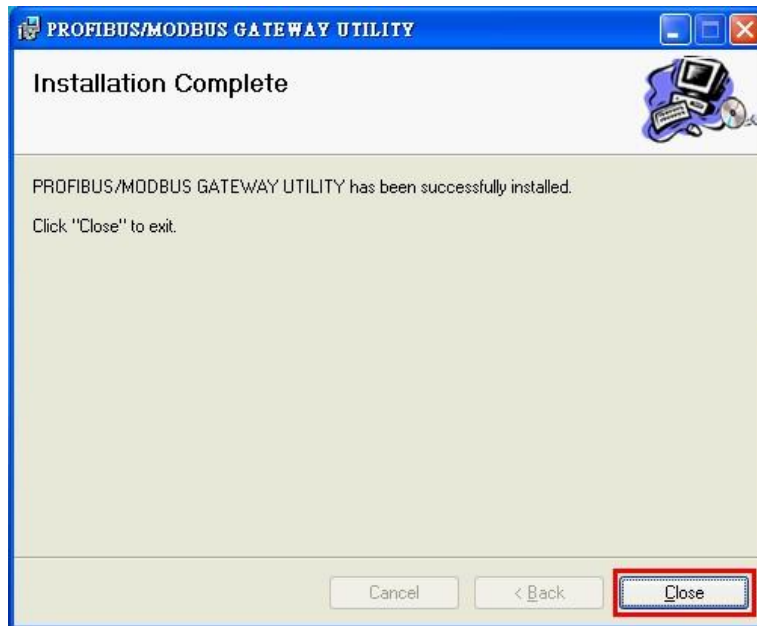

Figure 53 Installation complete

Step 6 :

After finishing the installation of the Profibus/Modbus Gateway Utility, users can find the Utility as shown in the following screen shot.



Figure 54 The path of Utility

5.2 Utility introduction

By this utility, the user can understand the module address of Profibus、Modbus and the GW-7552. The utility also support users set safe value easily. It introduces main window of the utility first as shown in *figure 55*.

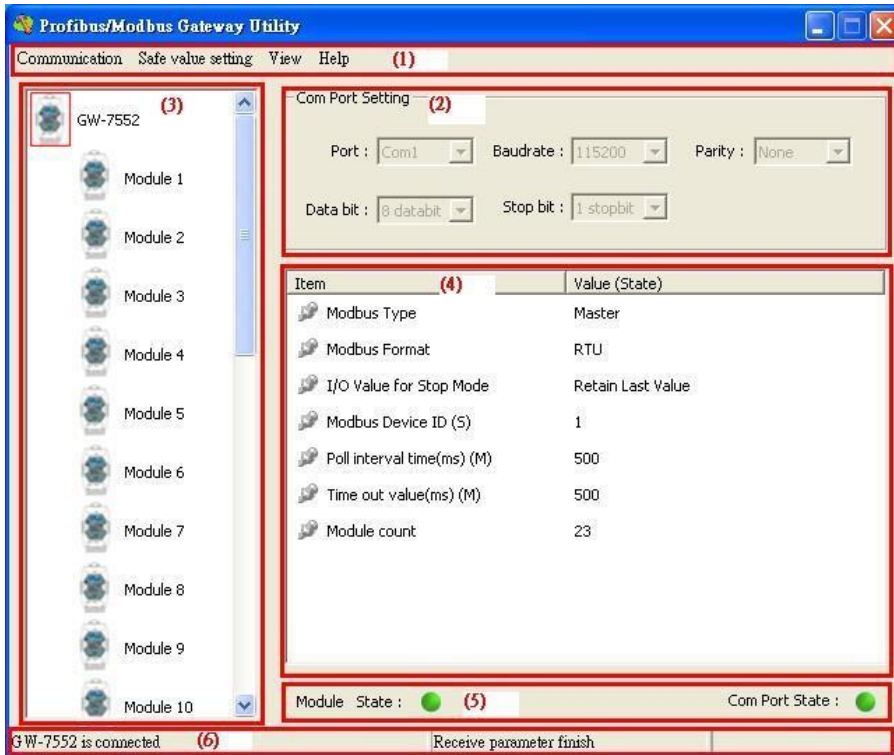

Figure 55 Main window of the utility

Main window of the utility has 6 parts, they are (1)Menu、(2)Com port settings、(3)Module state、(4)Module parameters、(5)Connection status of GW-7552 and com port、(6) Status bar, as shown in the below.

5.2.1 Menu :

1. Communication =>

- a. Connect : Open Com Port and connect with the GW-7552
- b. Disconnect : Close Com Port and disconnect with the GW-7552
- c. Exit : Exit from the utility

2. Safe Value Setting =>

- a. New Setting : Open a new safe value setting.
- b. Load from file : Load a safe value setting from the file.
- c. Load from device : Load a safe value setting from the GW-7552.

3. View =>

- a. Space configuration in device : Display memory address configuration of select module in the GW-7552.
- b. Space configuration in profibus : Display memory address configuration of select module in Profibus master station.
- c. Space configuration in modbus : Display memory address configuration of select module in the Modbus.

4. Help =>

- a. About Utility : Show about version of the utility.

5.2.2 Com Port settings :

1. Port: Com1~Com8
2. Baud rate: 2400/4800/9600/19200/38400/57600/115200
3. Parity: None/Odd/Even
4. Data bit: 8 data bit
5. Stop bit: 1 stop bit

5.2.3 Module state :

It can display the number of modules in the GW-7552 and display module parameters in the window of the module parameter by click the module's ICON.

5.2.4 Module parameters :

Display module parameters of the GW-7552.

5.2.5 Connection status of device and com port :

Module state : Display connection status between the utility and the GW-7552.

The green color means connected and the red color means disconnected.

Com Port state : Display state of the PC's com port. The green color means Com Port is open and the red color means Com Port is close.

5.2.6 Status bar :

Display messages about Com Port connection、the GW-7552 connection and the progress of data transmission.

5.3 Memory address configuration of the module

There are 3 kinds of memory address configuration. They are (1)Space configuration in device 、(2) Space configuration in profibus 、(3)Space configuration in modbus, as shown in *figure 56*.

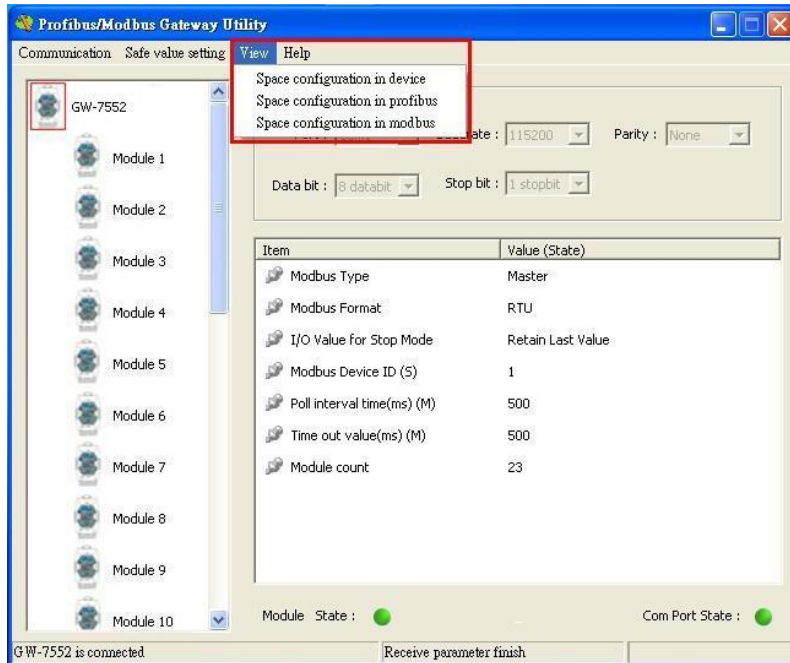

Figure 56 The menu of space configuration

5.3.1 Space configuration in device :

The user can select check box of the module to show memory address configuration of DI/DO/AI/AO in the GW-7552, as shown in *figure 57*.

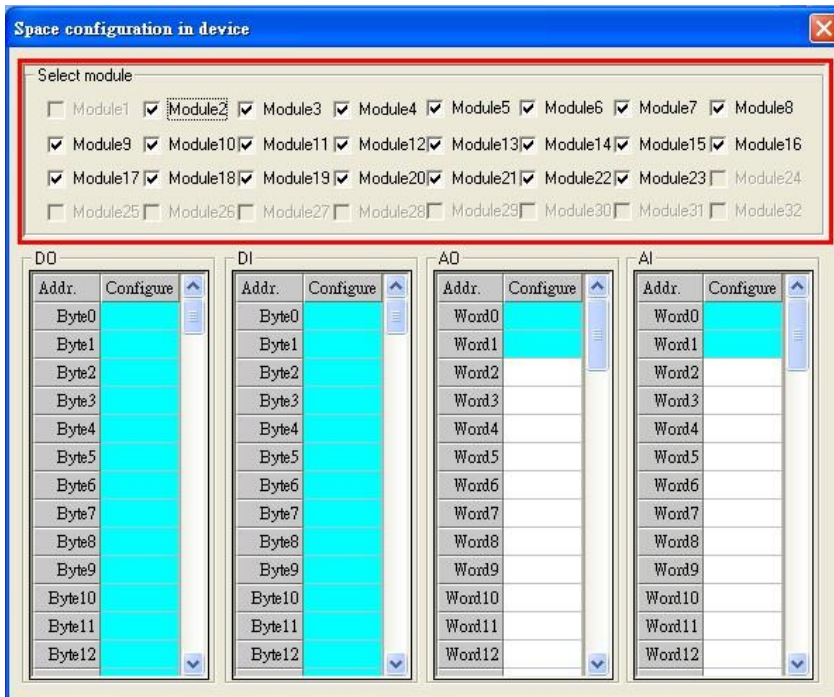

Figure 57 Space configuration in device

5.3.2 Space configuration in profibus :

The user can select check box of the module to show memory address configuration of I/O data area in the Profibus master station, as shown in *figure 58*.

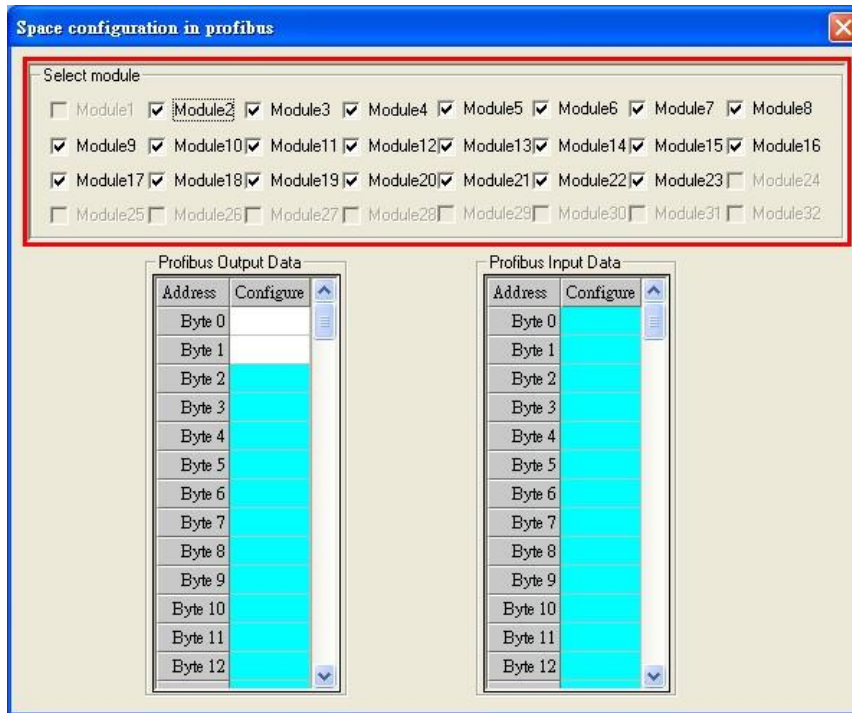

Figure 58 Space configuration in profibus

5.3.3 Space configuration in modbus :

The window of “Space Configuration in Modbus” divided into 3 parts to explain, as shown in *figure 59*.

(1) Select module:

The user can select check box of the module to show memory address configuration of DI/DO/AI/AO in Modbus network.

(2) Display interface:

The user can click “Write Output” button to show DO/AO memory address configuration of output modules in Modbus network, click “Read Input” button to show DI/AI memory address configuration of input modules in Modbus network, click “Read Output” button to show DO/AO memory address configuration of input modules in Modbus network.

(3) Color display:

The user can discriminate states of Modbus address configuration by

different color. White means the address is not used. Light blue means the address was configured by a module. Mazarine means the address was configured by many modules, but Modbus ID is not repeat in these modules. Red means the address was configured by many modules and Modbus ID is repeat in these modules. The data may be read and written by different modules at this time, it may make the data transmit and device control error easy because address configuration and Modbus ID overlap.

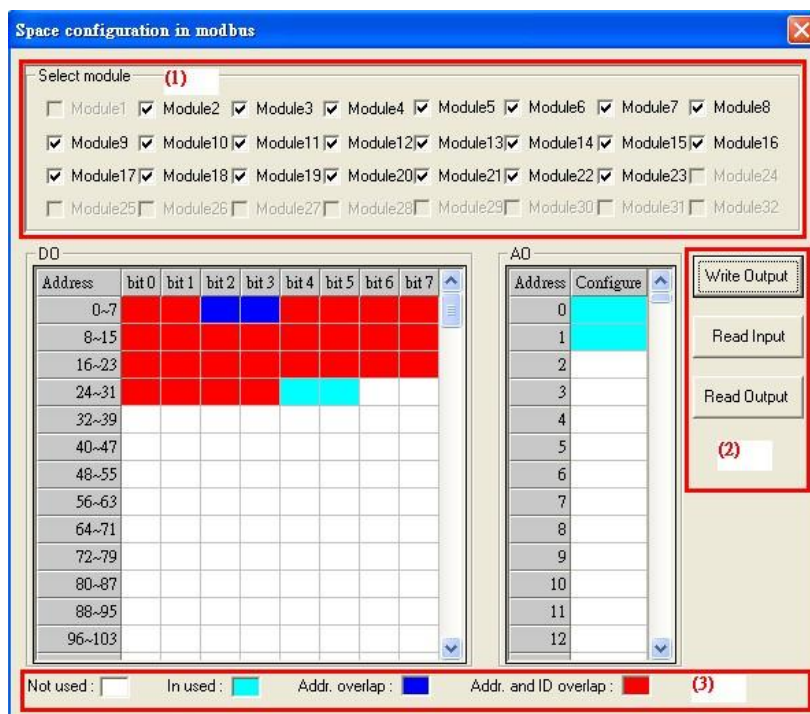

Figure 59 Space configuration in modbus

5.4 Safe value setting

There are 3 kinds of safe value setting. They are (1) Open a new setting 、(2)Load from file 、(3)Load from device, as shown in figure 60.

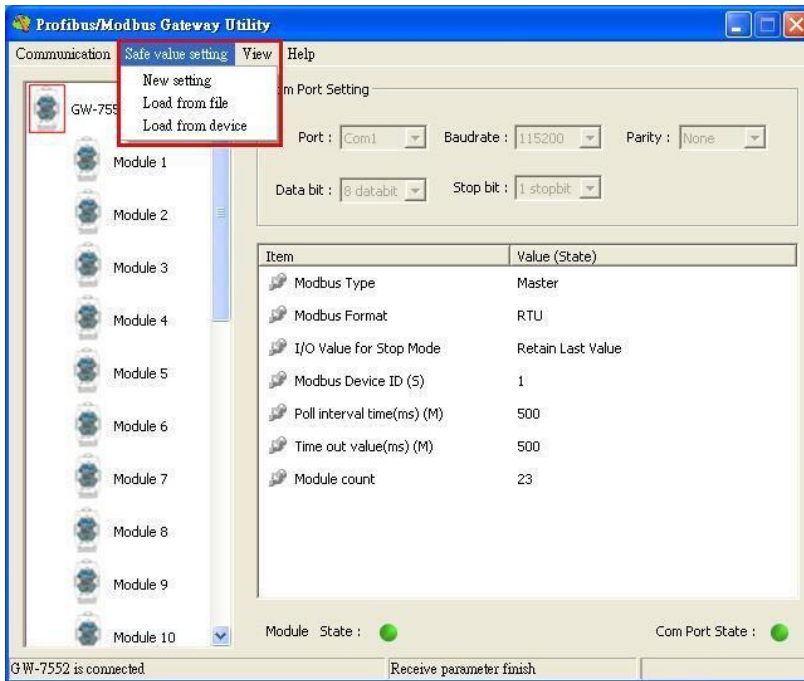

Figure 60 The menu of safe value setting

The window of “Safe Value Setting” divided into 6 parts to explain, as shown in figure 61.

(1) Select module:

The user can select check box of the module to know memory address configuration of the module for set safe value of the module.

(2) DI/O table:

The user can double click left button of mouse at the value of DI/DO to change the value from “H” to “L” or “L” to “H”.

(3) All DI/O setting:

The user can click “All set to H” button to set all of DI/DO to “H” and click “All set to L” button to set all of DI/DO to “L”.

(4) AI/O table:

The user can double click left button of mouse at the value of AI/AO to change the value into 0000~FFFF.

(5) All AI/O setting:

The user can click “All set to F” button to set all of AI/AO to “FFFF” and click “All set to 0” button to set all of AI/AO to “0000”.

(6) Display and Save interface

The user can click “Output” button to show safe value setting of DO/AO, click “Input” button to show safe value setting of DI/AI, click “Save to File” button to open “save file dialog” to save safe value setting for backup, click “Save to Device” button to save safe value setting to EEPROM of the GW-7552.

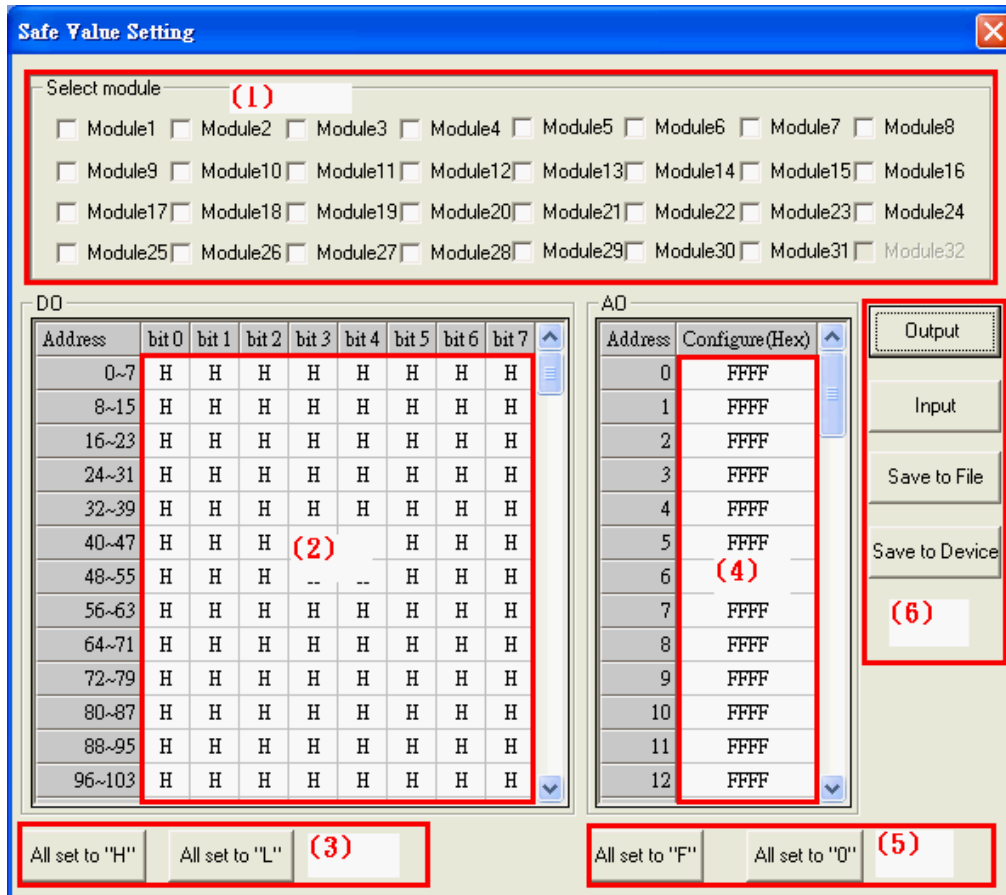

Figure 61 Safe value setting

5.5 Establish connection with GW-7552

The connection of Utility and GW-7552 is shown in *figure 62*. Please follow the steps to establish connection.

Step 1:

Wire Com Port of PC to RS-232 port of GW-7552.

Step 2:

Connect Profibus cable between Profibus master station and GW-7552 and enter data exchange mode (please refer step 1~6 of section 4.8

Profibus and Modbus data exchange demo for detail). The RUN LED of GW-7552 is going to light at this time.

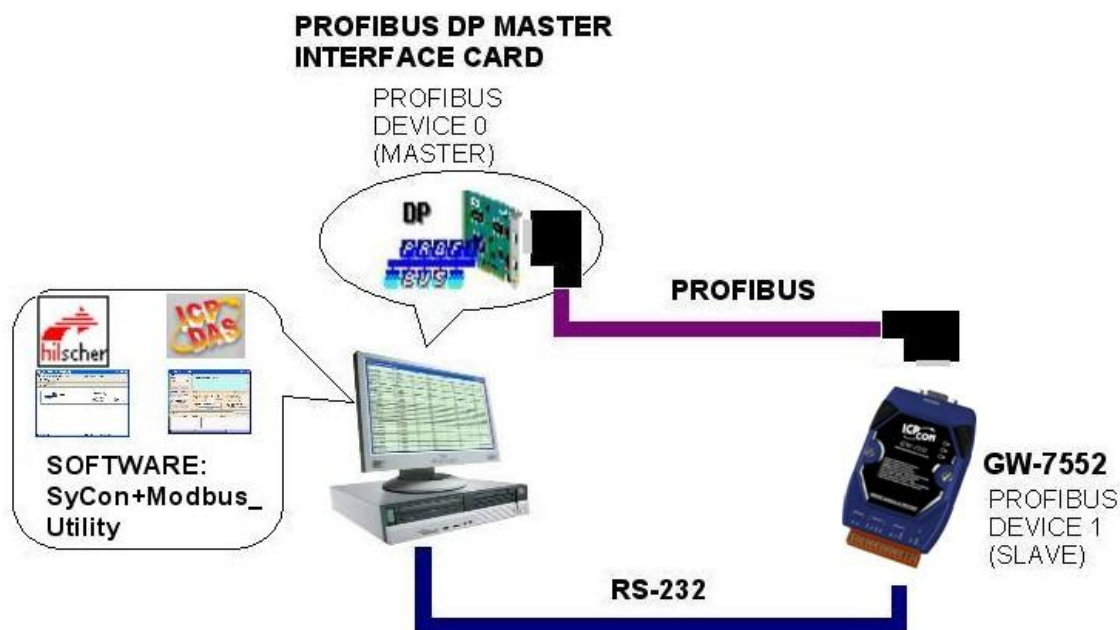

Figure 62 The connection of Utility and GW-7552

Step 3:

Set bit 2 of byte 1 to High in output data area of the Profibus master station (set the GW-7552 to setting mode; please refer section 4.6.2 Output data area and communication command).

Step 4:

Open Utility.exe on PC.



Figure 63 Open Utility

Step 5:

Set Com Port communication setting of Utility (please refer section 5.2.2 Com Port settings) the same as Com Port setting of GW-7552(please refer section 4.3 The Configuration of the common parameters)

Step 6:

Click “Communication=>Connect” button in menu.

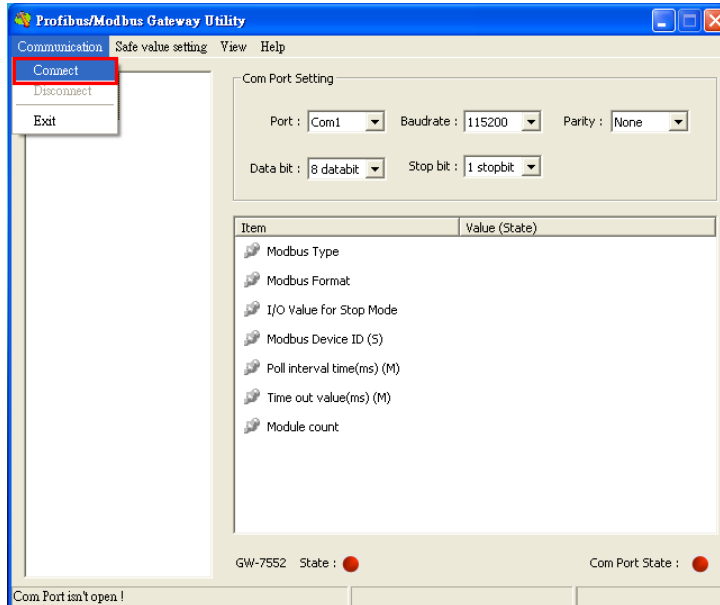

Figure 64 Communication menu

Step 7:

Module state shows green in the Utility now, it means the connection is complete.

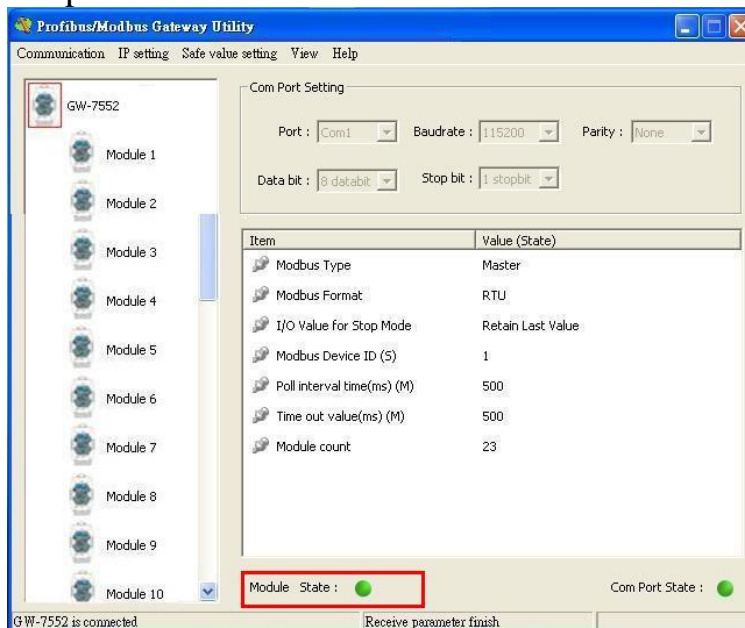

Figure 65 Display connection state

6. Troubleshooting

The troubleshooting list can help users to resolve the problems when using the GW-7552. If the problem still can't be solved, please contact with technical staff of ICP DAS.

Table 17 Errors and solutions

Item	Trouble state	Solution
1	'PWR' LED indication of the GW-7552 is always turned off	The power supply of GW-7552 has some problems. Please check the wire connection of the power and the voltage is between 10~30VDC.
2	'ERR' LED indication of the GW-7552 is always turned on	That means the GW-7552 isn't connecting to the PROFIBUS master station. Please check the wire connection and the PROFIBUS master station. The configuration and address of GW-7552 in the PROFIBUS master station are not correct.
3	'ERR' LED indication of the GW-7552 is flashing fast	It means the GW-7552 is in setting mode and connects with Utility. Please close Utility and set the GW-7552 to operation mode (please refer section 2.6 Normal/Setting Dip Switch and section 4.6.2 Output data area and communication command).
4	'ERR' LED indication of the GW-7552 is flashing slow	It means the GW-7552 has diagnostic messages. Please check diagnostic messages in the Profibus master station.
5	Profibus master station can not communicate with the Modbus device, when "RUN LED" of the GW-7552 is light and "ERR LED" of the GW-7552 is dark.	<ol style="list-style-type: none"> Please confirm the GW-7552 is working in operation mode and avoid clearing diagnostic message by communication command (please refer section 2.6 Normal/Setting Dip Switch and section 4.6.2 Output data area and communication command). Please confirm the connection between the GW-7552 and Modbus device. Please confirm Com Port setting of the GW-7552 (please refer section 4.3 The Configuration of the common parameters) the same as Com Port setting of the Modbus device. Please confirm module ID of the GW-7552 (please refer section 4.3 The Configuration of the common parameters and section 4.4 The Configuration of the modules) the same as Modbus address of Modbus device. Please confirm Setting of Start Address and NO. of Relay/Coil is correct (please refer section 4.4 The Configuration of the modules). Please confirm the output data put in correct address and have changed value of byte 0 to trigger the output command, when output data can not send to modbus device in output data area of Profibus master (please refer section 4.6.2 Output data area and communication command).

7. Dimensions

