

DOC15003-B5

This guide provides basic information for Unitronics' controllers V560-T25B.

### General Description

V560 OPLCs are programmable logic controllers that comprise a built-in operating panel containing a 5.7" Color Touchscreen. The V560 offers an alpha-numeric keypad with function keys as well as a virtual keyboard. Either may be used when the application requires the operator to enter data.

#### Communications

- 2 isolated RS232/RS485 ports
- Isolated CANbus port
- The user can order and install an Ethernet port
- Communication Function Blocks include: SMS, GPRS, MODBUS serial/IP Protocol FB enables PLC to communicate with almost any external device, via serial or Ethernet communications

#### I/O Options

V560 supports digital, high-speed, analog, weight and temperature measurement I/Os via:

- Snap-in I/O Modules  
Plug into the back of the controller to provide an on-board I/O configuration
- I/O Expansion Modules  
Local or remote I/Os may be added via expansion port or CANbus.



Installation instructions and other data may be found in the module's technical specification sheet.

#### Information Mode

This mode enables you to:

- Calibrate the touchscreen
- View & Edit operand values, COM port settings, RTC and screen contrast/brightness settings
- Stop, initialize, and reset the PLC

To enter Information Mode, press the <i> button, or press the touchscreen and maintain contact for several seconds.

#### Programming Software, & Utilities

The Unitronics Setup CD contains VisiLogic software and other utilities

- VisiLogic  
Easily configure hardware and write both HMI and Ladder control applications; the Function Block library simplifies complex tasks such as PID. Write your application, and then download it to the controller via the programming cable included in the kit.
- Utilities  
These include UniOPC server, Remote Access for remote programming and diagnostics, and DataXport for run-time data logging.

To learn how to use and program the controller, as well as use utilities such as Remote Access, refer to the VisiLogic Help system.

<b>Removable Memory Storage</b>	SD card: store datalogs, Alarms, Trends, Data Tables; export to Excel; backup Ladder, HMI & OS and use this data to 'clone' PLCs. For more data, refer to the <i>SD</i> topics in the VisiLogic Help system.
<b>Data Tables</b>	Data tables enable you to set recipe parameters and create datalogs.



Additional product documentation is in the Technical Library, located at [www.unitronicsplc.com](http://www.unitronicsplc.com).  
Technical support is available at the site, and from [support@unitronics.com](mailto:support@unitronics.com).

## Standard Kit Contents

Vision controller	Mounting brackets (x4)
3 pin power supply connector	Rubber seal
5 pin CANbus connector	Extra set of keypad slides
CANbus network termination resistor	
Battery (not installed)	

## Danger Symbols

When any of the following symbols appear, read the associated information carefully.

Symbol	Meaning	Description
	Danger	The identified danger causes physical and property damage.
	Warning	The identified danger could cause physical and property damage.
<i>Caution</i>	Caution	Use caution.

- Before using this product, the user must read and understand this document.
- All examples and diagrams are intended to aid understanding, and do not guarantee operation. Unitronics accepts no responsibility for actual use of this product based on these examples.
- Please dispose of this product according to local and national standards and regulations.
- Only qualified service personnel should open this device or carry out repairs.

 Failure to comply with appropriate safety guidelines can cause severe injury or property damage.

- Do not attempt to use this device with parameters that exceed permissible levels.
- To avoid damaging the system, do not connect/disconnect the device when power is on.

## Environmental Considerations

 Do not install in areas with: excessive or conductive dust, corrosive or flammable gas, moisture or rain, excessive heat, regular impact shocks or excessive vibration, in accordance with the standards given in the product's technical specification sheet.

- Ventilation: 10mm space required between controller's top/bottom edges & enclosure walls.
- Do not place in water or let water leak onto the unit.
- Do not allow debris to fall inside the unit during installation.
- Install at maximum distance from high-voltage cables and power equipment.

## Inserting the Battery

In order to preserve data in case of power-off, you must insert the battery.

The battery is supplied taped to the battery cover on the rear of the controller.

1. Remove the battery cover shown on page 4. The polarity (+) is marked on the battery holder and on the battery.
2. Insert the battery, ensuring that the polarity symbol on the battery is:
  - facing up
  - aligned with the symbol on the holder
3. Replace the battery cover.

## Mounting

### Dimensions

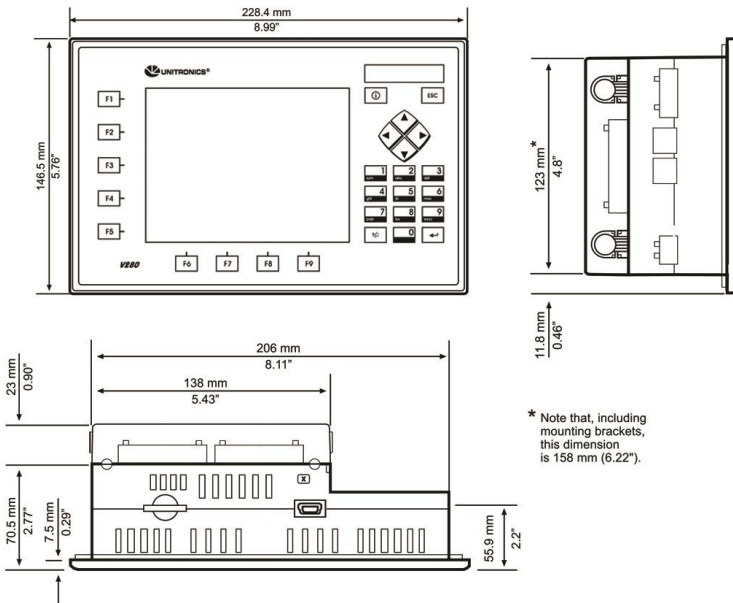

\* Note that, including mounting brackets, this dimension is 158 mm (6.22").

Note that the LCD screen may have a single pixel that is permanently either black or white.

## Panel Mounting

Before you begin, note that the mounting panel cannot be more than 5 mm thick.

1. Make a panel cut-out according to the dimensions in the figure to the right.
2. Slide the controller into the cut-out, ensuring that the rubber seal is in place.
3. Push the 4 mounting brackets into their slots on the sides of the controller as shown in the figure to the right.
4. Tighten the bracket screws against the panel. Hold the bracket securely against the unit while tightening the screw.
5. When properly mounted, the controller is squarely situated in the panel cut-out as shown below.

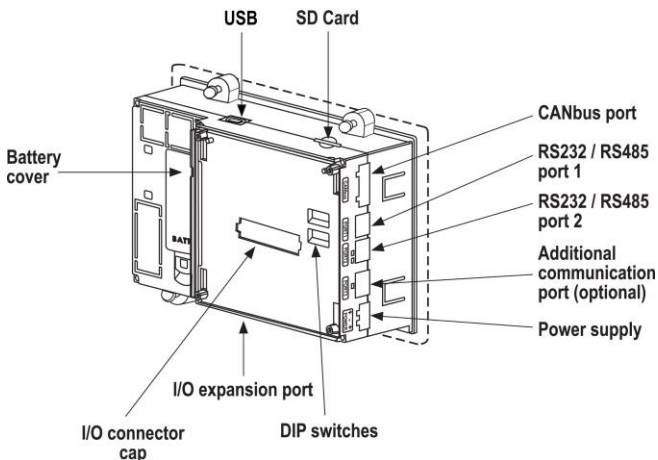
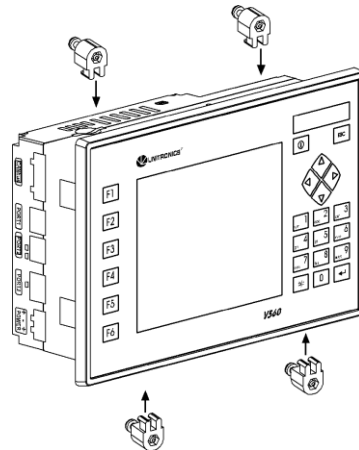
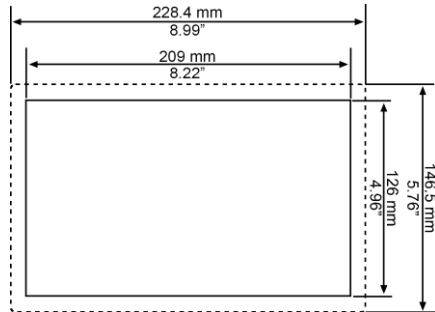

## Wiring



- Do not touch live wires.



- Install an external circuit breaker. Guard against short-circuiting in external wiring.
- Use appropriate circuit protection devices.
- Unused pins should not be connected. Ignoring this directive may damage the device.
- Double-check all wiring before turning on the power supply.

### Caution

- To avoid damaging the wire, do not exceed a maximum torque of 0.5 N·m (5 kgf·cm).
- Do not use tin, solder, or any substance on stripped wire that might cause the wire strand to break.
- Install at maximum distance from high-voltage cables and power equipment.

## Wiring Procedure

Use crimp terminals for wiring; use 26-12 AWG wire (0.13 mm<sup>2</sup>–3.31 mm<sup>2</sup>).

1. Strip the wire to a length of 7±0.5mm (0.250–0.300 inches).
2. Unscrew the terminal to its widest position before inserting a wire.
3. Insert the wire completely into the terminal to ensure a proper connection.
4. Tighten enough to keep the wire from pulling free.

## Power Supply

The controller requires either an external 12 or 24VDC power supply.

Permissible input voltage range: 10.2-28.8VDC, with less than 10% ripple.



- The power supply must include double insulation. Outputs must be rated as SELV/PELV/Class 2/Limited Power.
- Do not connect either the 'Neutral' or 'Line' signal of the 110/220VAC to device's 0V pin.



- Install an external circuit breaker. Guard against short-circuiting in external wiring.
- Double-check all wiring before turning on the power supply.
- In the event of voltage fluctuations or non-conformity to voltage power supply specifications, connect the device to a regulated power supply.

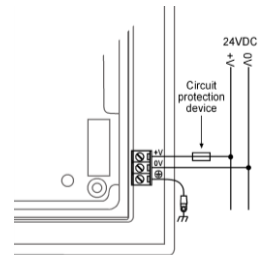

## Earthing the OPLC

To maximize system performance, avoid electromagnetic interference by:

- Mounting the controller on a metal panel.
- Connect the functional earth terminal of the OPLC, and the common and ground lines of I/Os, directly to the earth ground of your system.
- For ground wiring, use the shortest and thickest possible wire.

## Communication Ports

This series comprises a USB port, 2 RS232/RS485 serial ports and a CANbus port.



- Turn off power before making communications connections.

**Caution** ▪ Always use the appropriate port adapters.

The USB port may be used for programming, OS download, and PC access.

Note that **COM port 1 function is suspended when this port is physically connected to a PC.**

The serial ports are type RJ-11 and may be set to either RS232 or RS485 via DIP switches, in accordance with the table shown below.

Use RS232 to download programs from a PC, and to communicate with serial devices and applications, such as SCADA.

Use RS485 to create a multi-drop network containing up to 32 devices.

### Pinouts

The pinouts below show PLC port signals.

To connect a PC to a port that is set to RS485, remove the RS485 connector, and connect the PC to the PLC via the programming cable. Note that this is possible only if flow control signals are not used (which is the standard case).

RS232	
Pin #	Description
1*	DTR signal
2	0V reference
3	TXD signal
4	RXD signal
5	0V reference
6*	DSR signal

RS485**		Controller Port
Pin #	Description	
1	A signal (+)	
2	(RS232 signal)	
3	(RS232 signal)	
4	(RS232 signal)	
5	(RS232 signal)	
6	B signal (-)	

\*Standard programming cables do not provide connection points for pins 1 and 6.

\*\*When a port is adapted to RS485, Pin 1 (DTR) is used for signal A, and Pin 6 (DSR) signal is used for signal B.

### RS232 to RS485: Changing DIP Switch Settings

The ports are set to RS232 by factory default.

To change the settings, first remove the Snap-in I/O Module, if one is installed, and then set the switches according to the following table.

#### RS232/RS485: DIP Switch Settings

The settings below are for each COM port.

	Switch Settings					
	1	2	3	4	5	6
RS232*	ON	ON	ON	OFF	ON	OFF
RS485	OFF	OFF	OFF	ON	OFF	ON
RS485 with termination**	ON	ON	OFF	ON	OFF	ON

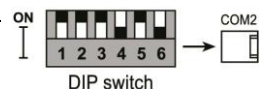
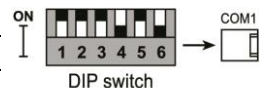

\*Default factory setting

\*\*Causes the unit to function as an end unit in an RS485 network

### **Removing a Snap-in I/O Module**

1. Locate the four screws on the sides of the controller, two on either side.
2. Press the buttons and hold them down to open the locking mechanism.
3. Gently rock the module from side to side, easing the module from the controller.

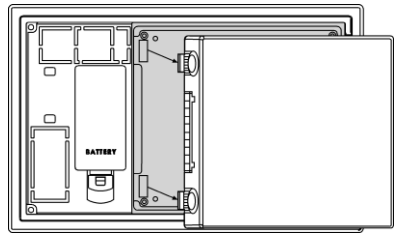
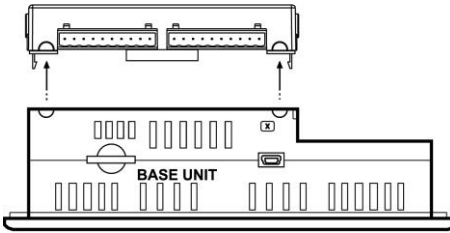

### **Re-installing a Snap-in I/O Module**

1. Line the circular guidelines on the controller up with the guidelines on the Snap-in I/O Module as shown below.
2. Apply even pressure on all 4 corners until you hear a distinct 'click'. The module is now installed. Check that all sides and corners are correctly aligned.

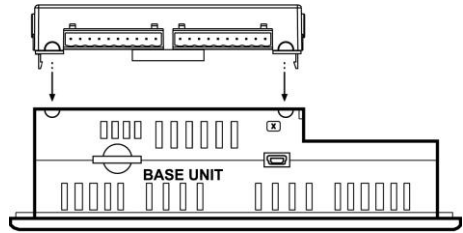
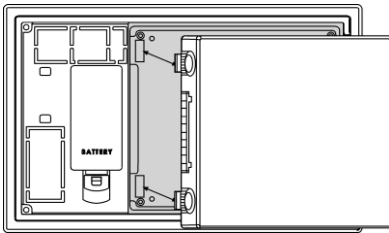

## CANbus

These controllers comprise a CANbus port. Use this to create a decentralized control network using one of the following CAN protocols:

- CANopen: 127 controllers or external devices
- CANLayer 2
- Unitronics' proprietary UniCAN: 60 controllers, (512 data bytes per scan)

The CANbus port is galvanically isolated.

## CANbus Wiring

Use twisted-pair cable. DeviceNet® thick shielded twisted pair cable is recommended.

Network terminators: These are supplied with the controller. Place terminators at each end of the CANbus network.

Resistance must be set to 1%, 121  $\Omega$ , 1/4W.

Connect ground signal to the earth at only one point, near the power supply.

- The network power supply need not be at the end of the network.

## CANbus Connector

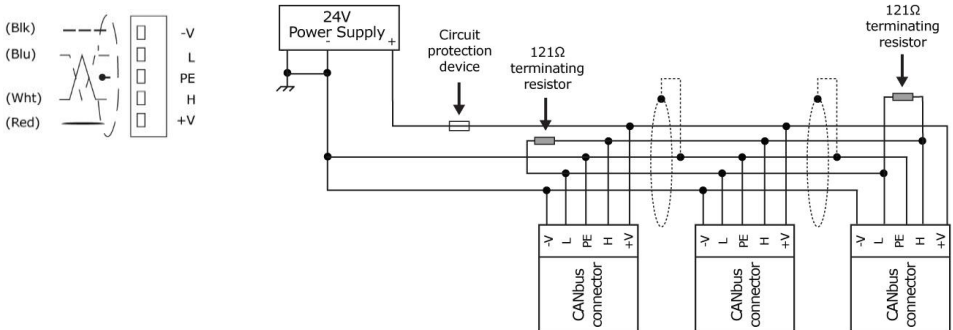

The information in this document reflects products at the date of printing. Unitronics reserves the right, subject to all applicable laws, at any time, at its sole discretion, and without notice, to discontinue or change the features, designs, materials and other specifications of its products, and to either permanently or temporarily withdraw any of the foregoing from the market.

All information in this document is provided "as is" without warranty of any kind, either expressed or implied, including but not limited to any implied warranties of merchantability, fitness for a particular purpose, or non-infringement. Unitronics assumes no responsibility for errors or omissions in the information presented in this document. In no event shall Unitronics be liable for any special, incidental, indirect or consequential damages of any kind, or any damages whatsoever arising out of or in connection with the use or performance of this information.

The tradenames, trademarks, logos and service marks presented in this document, including their design, are the property of Unitronics (1989) (R<sup>g</sup>) Ltd. or other third parties and you are not permitted to use them without the prior written consent of Unitronics or such third party as may own them.