



## Features

- Excellent C/P ratio (cost/performance)
- High-resolution color touch screen
- Multiple serial communication interfaces
- RTC (Real Time Clock)
- GUI design
- Free HMIWorks development tool
- Supports the popular C programming language and Ladder Designer
- Supports the custom communication protocol (C language)
- Modbus RTU and DCON protocol
- ESD Protection: 4 kV
- Operating temperature: -20 ~ 50°C



## Introduction

TPD 4.3 inch series is a series of tiny touch HMI and designed for building and home automation. TPD 4.3 inch series is equipped with high resolution TFT color touch screen seamlessly integrated with rich I/O modules and presents beautiful, flexible and user-defined picture frame. In short, it is the best choice to upgrade the mechanical switch to intelligent control pads.

For PLC users, HMIWorks provides Ladder Designer, and for IT users, C language environment is provided. Especially, it only takes no more than 30 minutes to learn how to create an application program of TPD-series devices when using Ladder Designer. It supports Modbus RTU protocols so that it enables remote control of I/O modules and integration with SCADA software. With all the features provided, TPD-series touch HMI Devices must be the most cost effective HMI Device ever been in the market.

## Applications

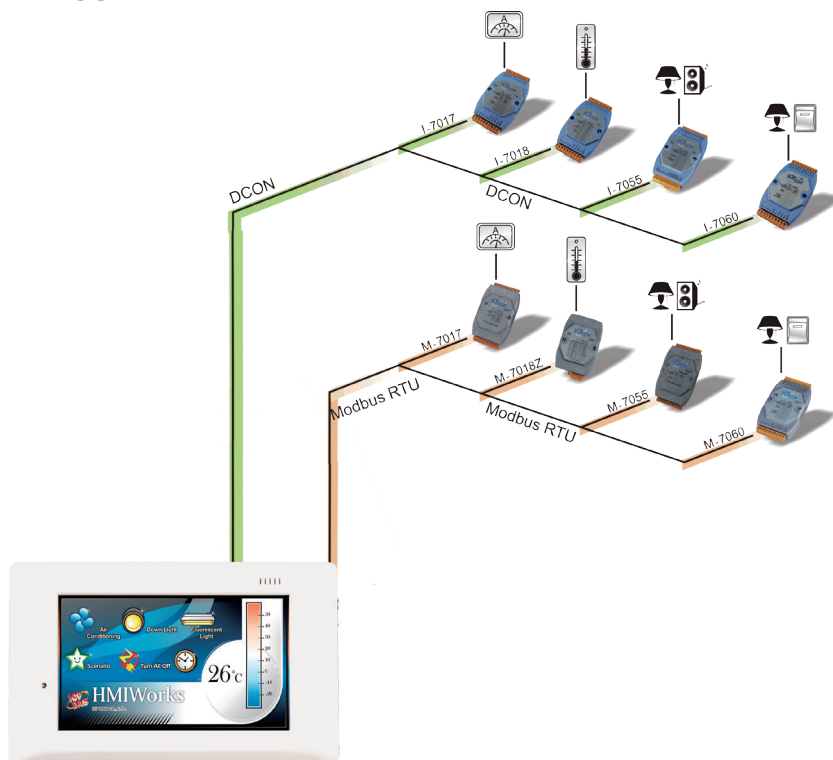

TPD-432F-H with External Wall Box EWB-T43F



TPD-432F-H with Outlet Box OB140F

## Specifications

Models	TPD-432F-H
<b>CPU Module</b>	
CPU	32-bit RISC CPU
Memory Expansion	16 MB SDRAM / 16 MB Flash
Real Time Clock (RTC)	Yes
Buzzer	Yes
Rotary Switch (0~9)	Yes
<b>Communication Interface</b>	
COM1	RS-485 (including Self-Tuner)
COM2	RS-485 (including Self-Tuner)
Ethernet	-
USB 1.1 Client	Firmware updates only
<b>MMI (Main Machine Interface)</b>	
LCD	4.3" TFT(Resolution 480 X 272 X 16), defective pixels <= 3
Backlight Life	20,000 hours
Brightness	400 cd/m2
Touch Panel	Yes
LED Indicator	Yes
Reset Button	Yes
<b>Electrical</b>	
Powered from Terminal Block	+12 ~ 48 VDC
Powered from PoE	-
Power Consumption	2.5 W
<b>Mechanical</b>	
Dimensions (W x L x H)	140 mm x 87 mm x 42 mm
Installation	Wall Mount
<b>Environmental</b>	
Operating Temperature	-20 ~ +50°C
Storage Temperature	-30 ~ +80°C
Ambient Relative Humidity	10 ~ 90% RH, non-condensing

## Appearance

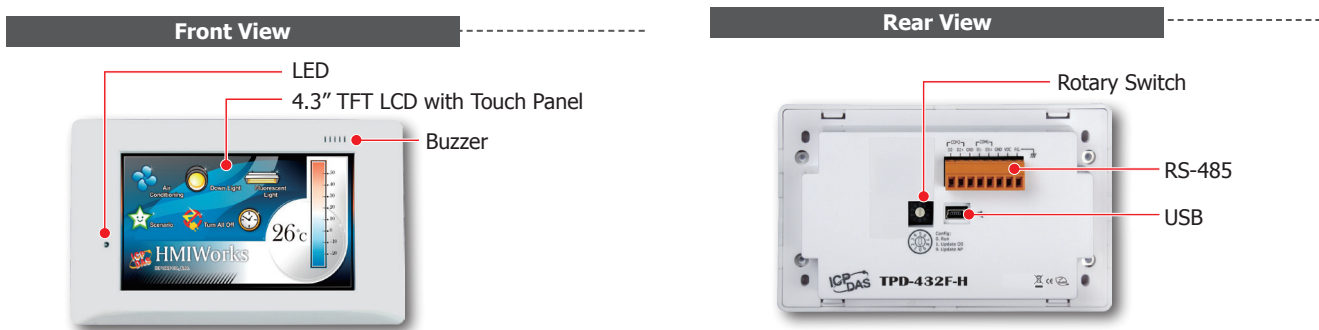

## Pin Assignments

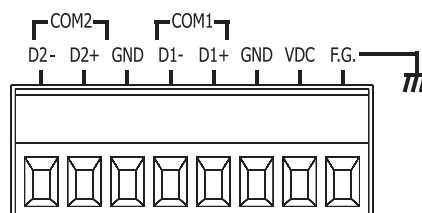



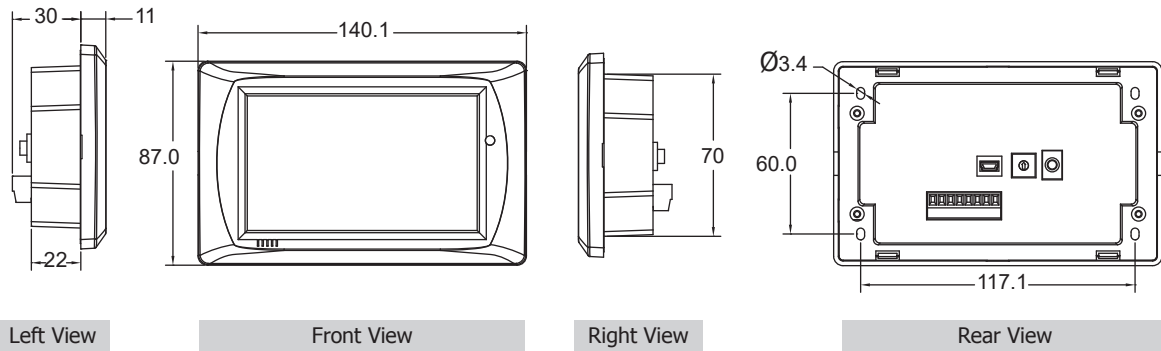



## ■ Dimensions (Units: mm)



## ■ Ordering Information

TPD-432F-H CR	4.3" Touch HMI device with RS-485 x 2, USB, RTC (RoHS)
---------------	--

## ■ Accessories

	CA-USB10	USB to 5P Mini-USB, 28AWG, 1.5 m
	1C016	2.4 mm Screw driver
	MDR-60-24 CR	24 VDC/2.5 A, 60 W Power Supply with DIN-Rail Mounting (RoHS)
	DIN-KA52F CR	24 VDC/1.04 A, 25 W Power Supply with DIN-Rail Mounting (RoHS)
	EWB-T43F	External Wall Box for TPD-432F-H
	OB140F	Outlet Box for TPD-432F-H
	OB140FP	Plastic outlet Box for TPD-432F-H