

# **MBB-1000AF Series**

**Intel® 12<sup>th</sup>/13<sup>th</sup> Gen. Core™ DT Processor  
Based  
ATX Motherboard**

## **User's Manual**

Version 1.0c  
(February 2024)

## **Copyright**

© 2024 IBASE Technology, Inc. All rights reserved.

No part of this publication may be reproduced, copied, stored in a retrieval system, translated into any language or transmitted in any form or by any means, electronic, mechanical, photocopying, or otherwise, without the prior written consent of IBASE Technology, Inc. (hereinafter referred to as “IBASE”).

## **Disclaimer**

IBASE reserves the right to make changes and improvements to the products described in this document without prior notice. Every effort has been made to ensure the information in the document is correct; however, IBASE does not guarantee this document is error-free.

IBASE assumes no liability for incidental or consequential damages arising from misapplication or inability to use the product or the information contained herein, nor for any infringements of rights of third parties, which may result from its use.

## **Trademarks**

All the trademarks, registrations and brands mentioned herein are used for identification purposes only and may be trademarks and/or registered trademarks of their respective owners.

## Compliance



This product has passed CE tests for environmental specifications and limits. This product is in accordance with the directives of the European Union (EU). In a domestic environment, this product may cause radio interference in which case users may be required to take adequate measures.



This product has been tested and found to comply with the limits for a Class B device, pursuant to Part 15 of the FCC Rules. These limits are designed to provide reasonable protection against harmful interference in a residential installation. This equipment generates, uses and can radiate radio frequency energy and, if not installed and used in accordance with manufacturer's instructions, may cause harmful interference to radio communications.

## WEEE



This product must not be disposed of as normal household waste, in accordance with the EU directive of for waste electrical and electronic equipment (WEEE - 2012/19/EU). Instead, it should be disposed of by returning it to a municipal recycling collection point. Check local regulations for disposal of electronic products.

## Green IBASE



This product is compliant with the current RoHS restrictions and prohibits use of the following substances in concentrations exceeding 0.1% by weight (1000 ppm) except for cadmium, limited to 0.01% by weight (100 ppm).

- Lead (Pb)
- Mercury (Hg)
- Cadmium (Cd)
- Hexavalent chromium (Cr6+)
- Polybrominated biphenyls (PBB)
- Polybrominated diphenyl ether (PBDE)

## Important Safety Information

Carefully read the precautions before using the board.

### Environmental conditions:

- Use this product in environments with ambient temperatures between 0°C and 60°C.
- Do not leave this product in an environment where the storage temperature may be below -20° C or above 80° C. To prevent from damages, the product must be used in a controlled environment.

### Care for your iBASE products:

- Before cleaning the PCB, unplug all cables and remove the battery.
- Clean the PCB with a circuit board cleaner or degreaser, or use cotton swabs and alcohol.
- Vacuum the dust with a computer vacuum cleaner to prevent the fan from being clogged.



### WARNING

### Attention during use:

- Do not use this product near water.
- Do not spill water or any other liquids on this product.
- Do not place heavy objects on the top of this product.

### Anti-static precautions

- Wear an anti-static wrist strap to avoid electrostatic discharge.
- Place the PCB on an anti-static kit or mat.
- Hold the edges of PCB when handling.
- Touch the edges of non-metallic components of the product instead of the surface of the PCB.
- Ground yourself by touching a grounded conductor or a grounded bit of metal frequently to discharge any static.



### CAUTION

Danger of explosion if the internal lithium-ion battery is replaced by an incorrect type. Replace only with the same or equivalent type recommended by the manufacturer. Dispose of used batteries according to the manufacturer's instructions or recycle them at a local recycling facility or battery collection point.

## Warranty Policy

- **IBASE standard products:**

24-month (2-year) warranty from the date of shipment. If the date of shipment cannot be ascertained, the product serial numbers can be used to determine the approximate shipping date.

- **3<sup>rd</sup>-party parts:**

12-month (1-year) warranty from delivery for the 3<sup>rd</sup>-party parts that are not manufactured by IBASE, such as CPU, CPU cooler, memory, storage devices, power adapter, panel and touchscreen.

- \* PRODUCTS, HOWEVER, THAT FAIL DUE TO MISUSE, ACCIDENT, IMPROPER INSTALLATION OR UNAUTHORIZED REPAIR SHALL BE TREATED AS OUT OF WARRANTY AND CUSTOMERS SHALL BE BILLED FOR REPAIR AND SHIPPING CHARGES.

## Technical Support & Services

1. Visit the IBASE website at [www.ibase.com.tw](http://www.ibase.com.tw) to find the latest information about the product.
2. If you need any further assistance from your distributor or sales representative, prepare the following information of your product and elaborate upon the problem.
  - Product model name
  - Product serial number
  - Detailed description of the problem
  - The error messages in text or in screenshots if there is any
  - The arrangement of the peripherals
  - Software in use (such as OS and application software, including the version numbers)
3. If repair service is required, you can download the RMA form at <http://www.ibase.com.tw/english/Supports/RMAService/>. Fill out the form and contact your distributor or sales representative.

# Table of Contents

---

<b>Chapter 1</b>	<b>General Information.....</b>	<b>1</b>
1.1	Introduction .....	2
1.2	Features.....	2
1.3	Packing List.....	3
1.4	Optional Accessories.....	3
1.5	Specifications .....	4
1.6	Block Diagram .....	7
1.7	Product View .....	8
1.8	Dimensions .....	10
<b>Chapter 2</b>	<b>Hardware Configuration .....</b>	<b>11</b>
2.1	Essential Installations Before You Begin.....	12
2.1.1	Installing the Memory .....	12
2.2	Setting the Jumpers.....	13
2.3	Jumper & Connector Locations.....	14
2.4	Jumpers Quick Reference .....	15
2.4.1	PCIe (x16) Bifurcation Select (JP1) .....	15
2.4.2	Clear CMOS Data (JP2).....	16
2.4.3	Clear RTC (JP3).....	16
2.4.4	AT / ATX Select (JP4) .....	17
2.4.5	Sierra EM9191 5G Card USB/PCIe Select (JP5) .....	18
2.4.6	Flash Descriptor Security Override (JP6).....	18
2.5	Connectors Quick Reference.....	19
2.5.1	COM1 & COM2 RS-232/422/485 Ports (CN7) .....	20
2.5.2	Front Panel Audio Connector (J1) .....	21
2.5.3	COM3, COM4 RS232 Serial Ports (J2, J3).....	22
2.5.4	Digital I/O Connector (4 in, 4 out) (J5) .....	23
2.5.5	PS2 Keyboard/Mouse Connector (J7) .....	24
2.5.6	DVI-D Connector (J8).....	25
2.5.7	SATA Connectors (CN8, CN9, CN10, CN11) .....	26
2.5.8	USB 2.0 Connector (J10) .....	27
2.5.9	USB 3.1 Connector (J11) .....	28
2.5.10	S3 Status Connector (J19) .....	29
2.5.11	Front Panel Settings Connector (J20).....	30
2.5.12	24-pin ATX Power (J22) .....	31
2.5.13	AT 12V Power Connector (ATX_12V_2X1) .....	32

2.5.14	CPU Fan Power Connector (CPU_FAN1) .....	33
2.5.15	System Fan Power Connector (SYS_FAN1, SYS_FAN2) .....	34
<b>Chapter 3</b>	<b>Drivers Installation .....</b>	<b>35</b>
3.1	Introduction .....	36
3.2	Intel® Chipset Software Installation Utility .....	36
3.3	VGA Driver Installation .....	38
3.4	Realtek HD Audio Driver Installation .....	40
3.5	Intel® ME Drivers Installation .....	41
3.6	Intel® Serial IO Drivers Installation .....	42
3.7	LAN Drivers Installation .....	43
<b>Chapter 4</b>	<b>BIOS Setup .....</b>	<b>45</b>
4.1	Introduction .....	46
4.2	BIOS Setup .....	46
4.3	Main Settings .....	47
4.4	Advanced Settings .....	48
4.5	Chipset Settings .....	60
4.6	Security Settings .....	65
4.7	Boot Settings .....	68
4.8	Save & Exit Settings .....	69
<b>Appendix</b>	<b>.....</b>	<b>71</b>
A.	I/O Port Address Map .....	72
B.	Interrupt Request Lines (IRQ) .....	74
C.	Watchdog Timer Configuration .....	76
D.	Onboard Connector Types .....	80
E.	MBB1000 USB Power Control Bit Mapping .....	81

This page is intentionally left blank.



# Chapter 1

## General Information

The information provided in this chapter includes:

- Features
- Packing List
- Optional Accessories
- Specifications
- Block Diagram
- Product View
- Board Dimensions

## 1.1 Introduction

MBB-1000AF is an ATX motherboard based on 12<sup>th</sup>/13<sup>th</sup> Gen Intel® Core™ i9/i7/i5/i3 and Pentium/ Celeron processors. With support for four DDR4 memory slots that accommodate up to 128GB, it features up to four independent displays with HDMI (2.0b), DVI-D, and DisplayPort (1.4) (DP++) and graphics interfaces. This high-performance platform is embedded with high-speed connectivity, to meet stringent demands in next-generation applications in imaging, AI, and edge computing, including dual Intel® LAN, 10 USB ports, four SATA III, four serial ports, and expansion interfaces such as 1x PCI-E(x16), 2x PCI-E(x4), 1x PCI-E(x1), 2x PCI, and 4x M.2 (B-Key, E-Key/ 2x M-Key).

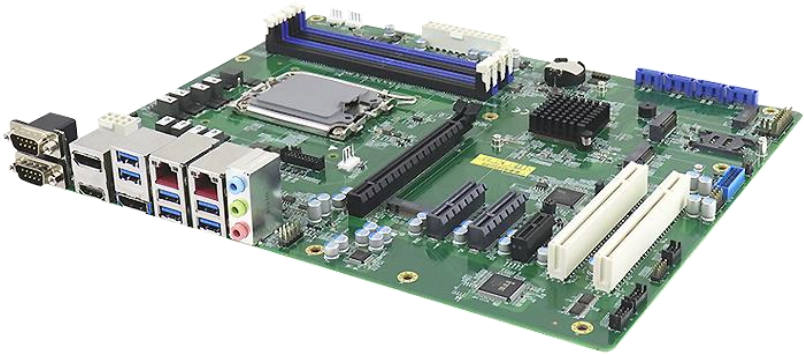

MBB-1000AF

## 1.2 Features

- 12th/13th Gen Intel® Core™ i9/i7/i5/i3 and Pentium/ Celeron processors
- 4x DDR4 DIMM, Max.128GB
- HDMI (2.0b), DVI-D, and DisplayPort (1.4) (DP++) graphics interfaces
- Dual Intel® LAN, 8x USB (3.1/3.2), 2x USB 2.0, 4x SATA 3.0, 4x COM
- 1x PCI-E(x16) (Gen5.0), 2x PCI-E(x4) (Gen4.0), 1x PCI-E(x1) (Gen3.0), 2x PCI
- 4x M.2 (B-Key, E-Key/ 2x M-Key)
- Watchdog timer, Digital I/O, iAMT (16.0), TPM

## 1.3 Packing List

Your MBB-1000AF package should include the items listed below. If any of the items below is missing, contact the distributor or dealer from whom you purchased the product.

- MBB-1000AF x 1
- IO Shield x 1
- SATA cable x 1
- COM cable x 1
- Disk (containing drivers) x 1
- This User's Manual x 1

## 1.4 Optional Accessories

IBASE provides optional accessories as follows:

- Audio cable
- USB 2.0 cable
- USB 3.0 cable
- PS/2 keyboard & mouse cable

## 1.5 Specifications

Model	MBB-1000AF-R	MBB-1000AF-Q	MBB-1000AF-W
Chipset	Intel® R680E	Intel® Q670E	Intel® W680
Form Factor	ATX Motherboard		
<b>System</b>			
Operating System	<ul style="list-style-type: none"> <li>Windows 10 (64-bit)</li> <li>Ubuntu (64-bit)</li> </ul>		
CPU Type	Intel® 12 <sup>th</sup> /13 <sup>th</sup> Gen. / Core™ i / Pentium® Gold / Celeron® DT processors **MBB-1000AF-W not support Pentium® Gold / Celeron® DT processors**		
CPU Socket	LGA1700		
Cache	Up to 30MB Intel Smart Cache		
Memory	4x DDR4-3200 MHz @1.2V, Max. = 128GB **ECC supported with R680E / W680 chipset**		
Storage	NVMe		
Graphics	12 <sup>th</sup> /13 <sup>th</sup> Gen Intel® Core™ i9/i7/i5/i3 processors integrated		
Ethernet	Intel® I226LM and Intel® I226V		
Super I/O	Fintek F81964D-I		
Audio Codec & Controller	Intel® ADL PCH-S built-in High Definition Audio controller Realtek audio codec ALC888S-VD2-GR w/ 7.1 channels		
System Voltage	ATX standard 24-pin type & 8-pin type		
Watchdog Timer	Yes (256 segments, 0, 1, 2...255 sec / min)		
BIOS	AMI BIOS		
iAMT 16.0	Supported by Intel® Core i9/i7/i5 CPU SKUs only		
H/W Monitor	Yes		
RAID	RAID 0/1/5/10		
TPM	Support fTPM		
Peripheral Device Power Control	USB 3.1 Type A stack connector (1 x GPIO)		

	M.2 E-Key (1 x GPIO) <b>**B-Key &amp; E-Key with PDPC feature, but CNVi modules is not supported**</b>
--	--

<b>Dimensions</b>	305mm x 244mm (12" x 9.6")
<b>RoHS 2</b>	Yes
<b>Certification</b>	CE, FCC Class B, LVD
<b>Others</b>	<ul style="list-style-type: none"> <li>- LAN Wakeup</li> <li>- Direct Connect Interface (Reserved)</li> <li>- AT mode boot-up by jumper (via Super I/O)</li> <li>- PDPC (Peripheral Device Power Control)</li> <li>- W680 is NOT in IoTG embedded use condition</li> </ul>
<b>I/O Ports</b>	
<b>Display</b>	Supports up to 4 independent displays: <ul style="list-style-type: none"> <li>- HDMI 2.0b (up to 4096 x 2160 @ 60 Hz)</li> <li>- DisplayPort /DP++ (via port C, DP1.4a, up to 7680 x 4320)</li> <li>- DisplayPort /DP++ (via port D, DP1.4a, up to 7680 x 4320)</li> <li>- DVI-D (up to 1920x1200 resolution, via box header)</li> </ul>
<b>LAN</b>	2 x RJ45 GbE LAN (Intel® I226LM 2.5G Intel® I226V 2.5GbE)
<b>USB</b>	<ul style="list-style-type: none"> <li>• 4x USB 3.2 Gen2 (10Gbps)</li> <li>• 2x USB 3.1 Gen1 (5Gbps)</li> <li>• 2x USB 3.1 Gen1 (5Gbps via box-header)</li> <li>• 2x USB 2.0 (via pin header)</li> </ul>
<b>Serial</b>	4 x COM ports: <ul style="list-style-type: none"> <li>• COM1 &amp; COM2: RS-232/422/485 (jumper-less selection)</li> <li>• COM3 &amp; COM4: RS-232 only (via box-headers)</li> </ul>
<b>SATA</b>	4 x SATA III
<b>Audio</b>	<ul style="list-style-type: none"> <li>• Line-In</li> <li>• Line-Out</li> <li>• Microphone-Input</li> </ul>
<b>Digital IO</b>	4-In & 4-Out

<b>Expansion Slots</b>	<ul style="list-style-type: none"><li>• 1x PCI-E(x16) (Gen5.0)</li><li>• 2x PCI-E(x4) (Gen4.0)</li><li>• 1x PCI-E(x1) (Gen3.0)</li><li>• 2x PCI</li><li>• 4x M.2 (B-Key, E-Key/ 2x M-Key)</li></ul>
<b>Mini Type Slots</b>	<ul style="list-style-type: none"><li>• 1x M.2 (M-Key, type:2280, supports NVMe with PCI-E(x4) Gen.4 signal only)</li><li>• 1x M.2 (M-Key, type:2280 , supports PCIe Gen.4 &amp; SATA)</li><li>• 1x M.2 (E-Key, type: 2230, supports CNVi)</li><li>• 1x M.2 (B-Key, type:3052, supports 5G/4G/LTE)</li></ul>
<b>Environment</b>	
<b>Temperature</b>	<ul style="list-style-type: none"><li>• Operating: 0 ~ 60 °C (32 ~ 140 °F)</li><li>• Storage: -20 ~ 80 °C (-4 ~ 176 °F)</li></ul>
<b>Relative Humidity</b>	0 ~ 90 %, non-condensing at 60 °C

All specifications are subject to change without prior notice.

## 1.6 Block Diagram

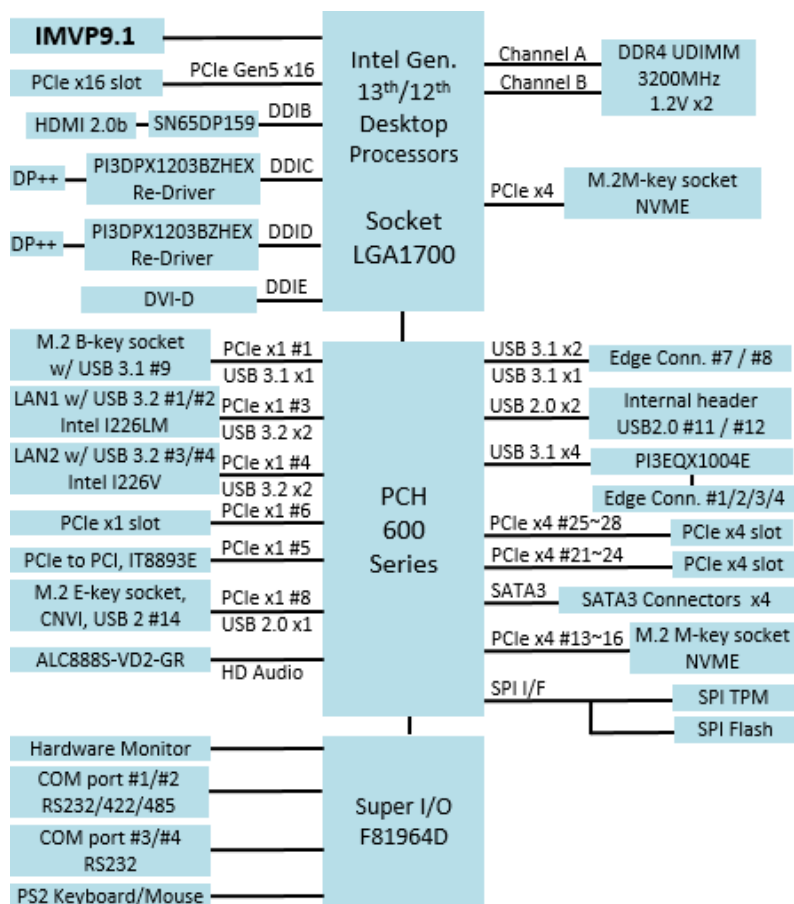

## 1.7 Product View

### Top View

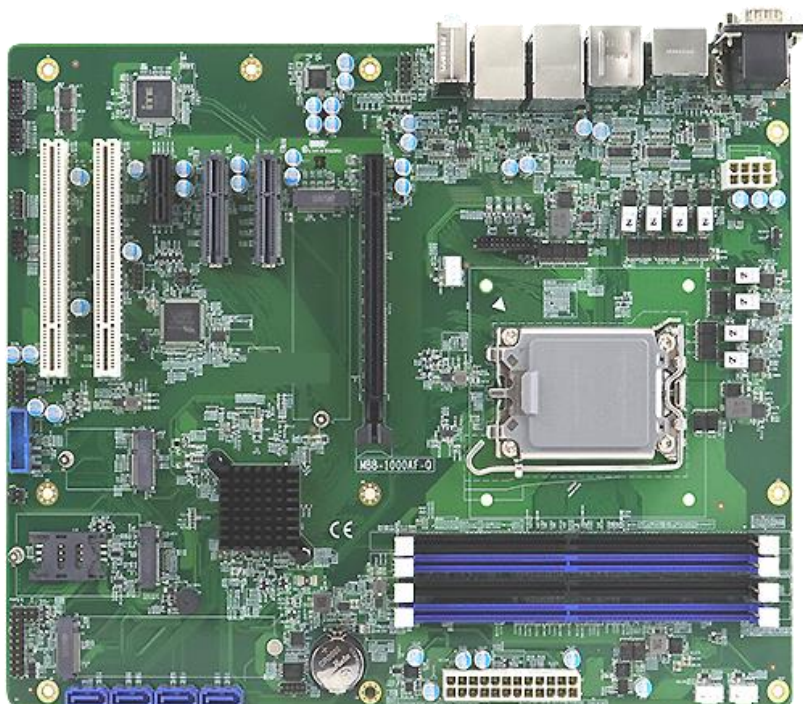

**MBB-1000AF**



## I/O View

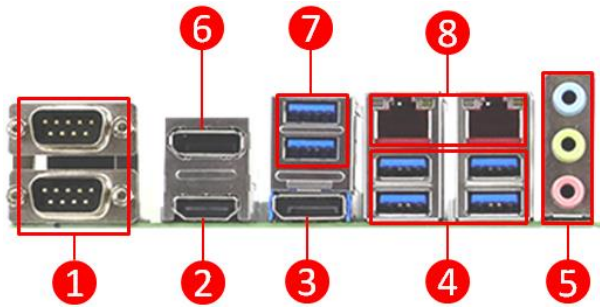

No.	Name	No.	Name
1	COM1 RS-232/422/485 (top) COM2 RS-232/422/485 (bottom)	5	Line In, Line Out, Microphone
2	HDMI	6	DisplayPort
3	DisplayPort	7	USB 3.1 Ports
4	USB 3.2 Ports	8	RJ45 for 2.5G Ethernet

## 1.8 Dimensions

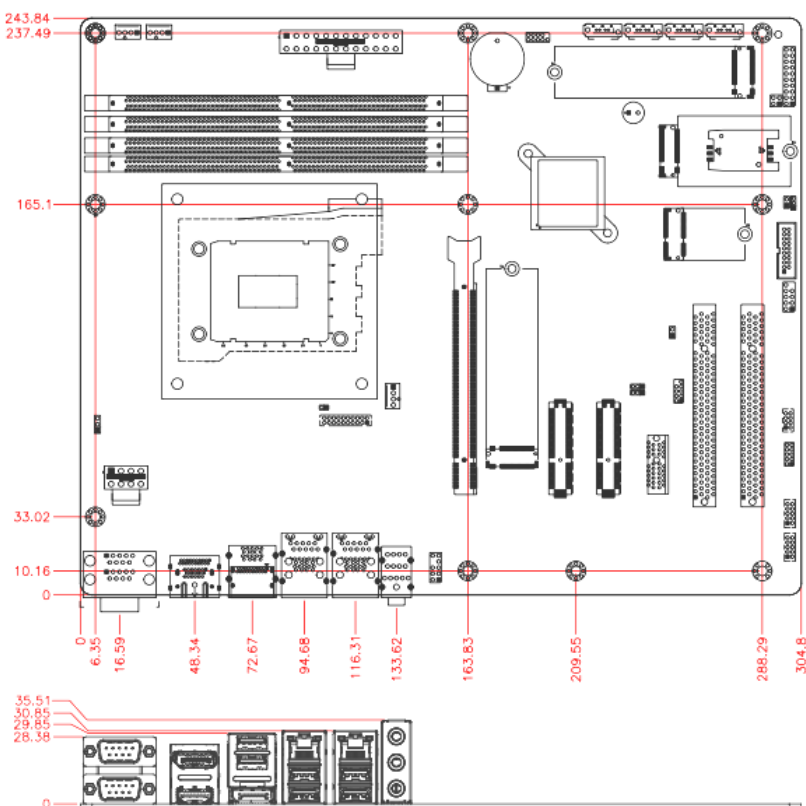

# Chapter 2

## Hardware Configuration

This section provides information on jumper settings and connectors on the MBB-1000AF and other installation information in order to set up a workable system. The topics covered are:

- Essential installations before you begin
- Jumper and connector locations
- Jumper settings and information of connectors

## 2.1 Essential Installations Before You Begin

Follow the instructions below to install the memory modules.

### 2.1.1 Installing the Memory

To install the modules, locate the memory slot on the board and perform the following steps:

1. Align the key of the memory module with that on the memory slot and insert the module slantwise.

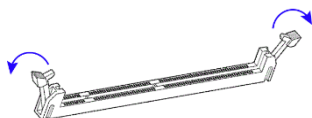

2. Gently push the module in an upright position until the clips of the slot close to hold the module in place when the module touches the bottom of the slot.

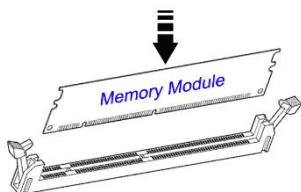

To remove the module, press the ejector tabs at both ends outwards.

## 2.2 Setting the Jumpers

Set up and configure your MBB-1000AF by using jumpers for various settings and features according to your needs and applications. Contact your supplier if you have doubts about the best configuration for your use.

### 2.2.1 How to Set Jumpers

Jumpers are short-length conductors consisting of several metal pins with a non-conductive base mounted on the circuit board. Jumper caps are used to have the functions and features enabled or disabled. If a jumper has 3 pins, you can connect either PIN1 to PIN2 or PIN2 to PIN3 by shorting.

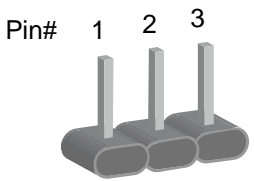

A 3-pin jumper

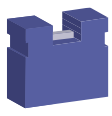

A jumper cap

Refer to the illustration below to set jumpers.

Pin closed	Oblique view	Illustration
Open		
1-2		
2-3		

When two pins of a jumper are encased in a jumper cap, this jumper is **closed**, i.e., turned **On**.

When a jumper cap is removed from two jumper pins, this jumper is **open**, i.e., turned **Off**.



## 2.4 Jumpers Quick Reference

Jumper	Function
JP1	PCIe (x16) Bifurcation Selection
JP2	Clear CMOS Data
JP3	Clear RTC
JP4	AT/ATX Select
JP5	Sierra EM919x 5G card USB/PCIe Select
JP6	Flash Descriptor Security Override (Factory use only)

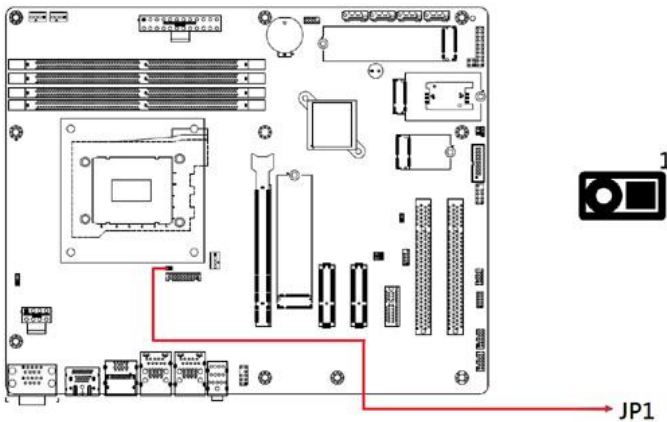

### 2.4.1 PCIe (x16) Bifurcation Select (JP1)



Function	Pin closed	Illustration
1 x PCIe (x16) <i>(default)</i>	Open	1
2 x PCIe (x8)	Close	1

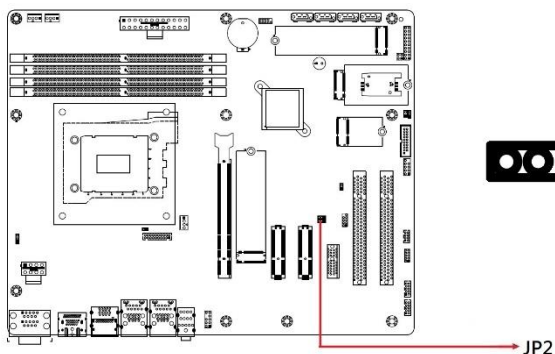

## 2.4.2 Clear CMOS Data (JP2)

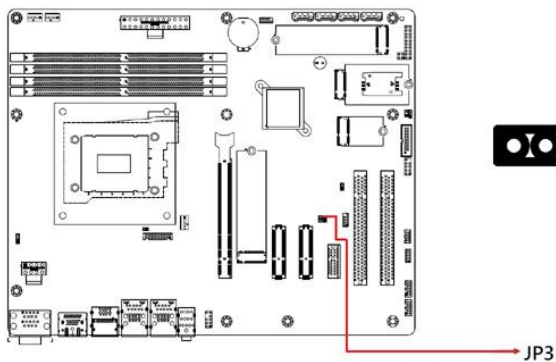

Function	Pin closed	Illustration
Normal (default)	1-2	 1
Clear CMOS	2-3	 1

## 2.4.3 Clear RTC (JP3)





Function	Pin closed	Illustration
Normal (default)	1-2	 1
Clear RTC	2-3	 1



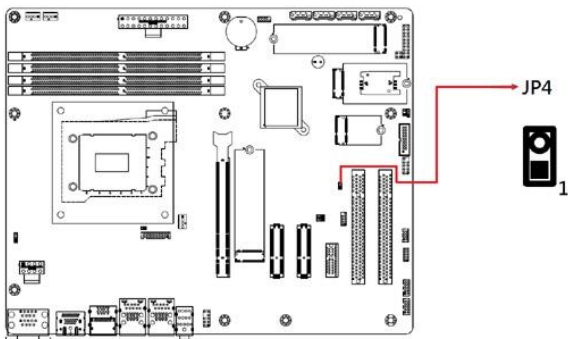

### 2.4.4 AT / ATX Select (JP4)



Function	Pin closed	Illustration
ATX (Default)	Open	 1
AT	Close	 1

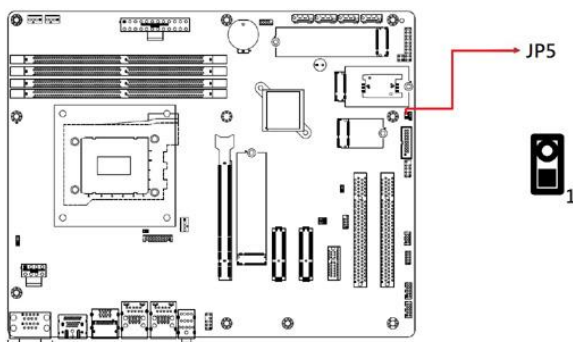

## 2.4.5 Sierra EM9191 5G Card USB/PCIe Select (JP5)

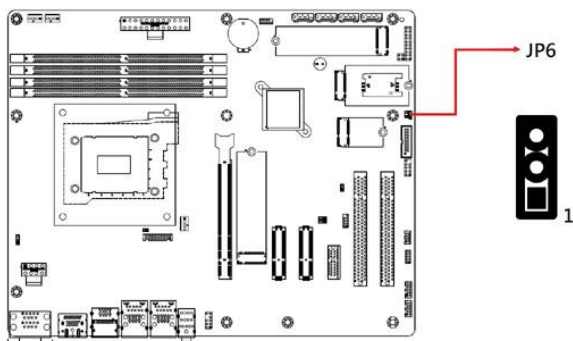

Function	Pin closed	Illustration
USB	1-2	 1
PCIe (default)	2-3	 1

## 2.4.6 Flash Descriptor Security Override (JP6)



Flash Descriptor Security Override	Pin	Illustration
Disabled (default)	Open	 1
Enabled	Close	 1

## 2.5 Connectors Quick Reference

Connector	Function
CN1	Audio Jack
CN2	2.5G LAN (KTI226V)+ USB3.2 GEN2 #3/#4
CN3	2.5G LAN (KTI226LM) + USB3.2 GEN2 #1/#2
CN4	DisplayPort
CN5	USB 3.2 #7/#8 (w/ power control)
CN6	DisplayPort (upper) and HDMI (bottom)
CN7	COM1 (upper) and COM2 (bottom)
CN8, CN9, CN10, CN11	SATA #4, SATA #5, SATA #6, SATA #7
J1	Front Panel Audio
J2	COM3
J3	COM4
J4	M.2 M-Key NVME (CPU)
J5	Digital I/O (4in, 4out)
J6	PWM programming (Factory use only)
J7	PS2 KB/MS
J8	DVI-D (HK_DF11-20S-PA66H)
J9	eSPI Debug (Factory use only)
J10	USB2.0 #11/#12
J11	USB3.2 #5/#6
J12	M.2 E-Key W/CNV1 (w/power control)
J13	DDR4 UDIMM CHA 0
J14	M.2 B-Key
J15	SIM Card slot
J16	DDR4 UDIMM CHA 1
J17	DDR4 UDIMM CHB 0
J18	DDR4 UDIMM CHB 1
J19	S3 Status connector
J20	Front Panel Settings
J21:	M.2 M-Key
J22:	24-pin ATX power connector
J23:	SPI Flash Connector (Factory use only)
CPU_FAN1	CPU fan power connector (PWM Only)
SYS_FAN1	System fan power connector (PWM Only)
SYS_FAN2	System fan power connector (PWM Only)

## 2.5.1 COM1 & COM2 RS-232/422/485 Ports (CN7)

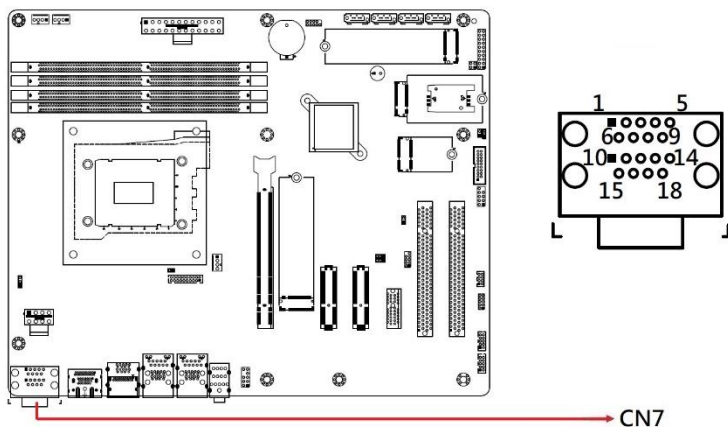

Pin	Signal Name		
	RS-232	RS-422	RS-485
1	DCD	TX-	DATA-
2	RX	TX+	DATA+
3	TX	RX+	NC
4	DTR	RX-	NC
5	Ground	Ground	Ground
6	DSR	NC	NC
7	RTS	NC	NC
8	CTS	NC	NC
9	RI	NC	NC
10	NC	NC	NC

## 2.5.2 Front Panel Audio Connector (J1)

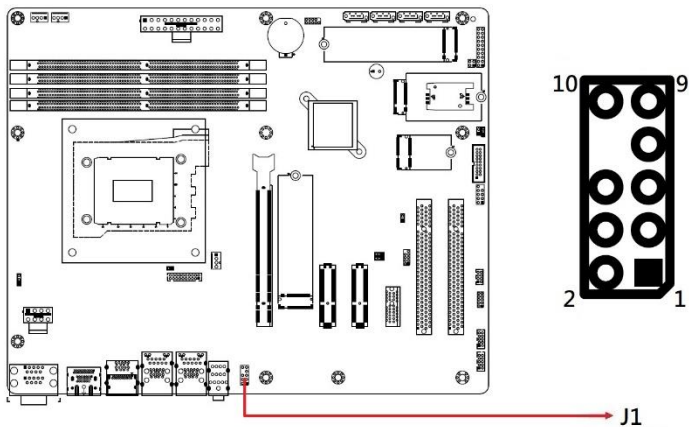

Pin	Signal Name	Pin	Signal Name
1	MIC IN_L	2	Ground
3	MIC IN_R	4	DET
5	LINE_R	6	Ground
7	Sense	8	Key
9	LINE_L	10	Ground

### 2.5.3 COM3, COM4 RS232 Serial Ports (J2, J3)

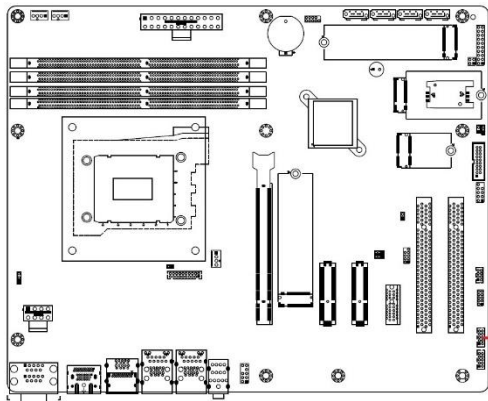
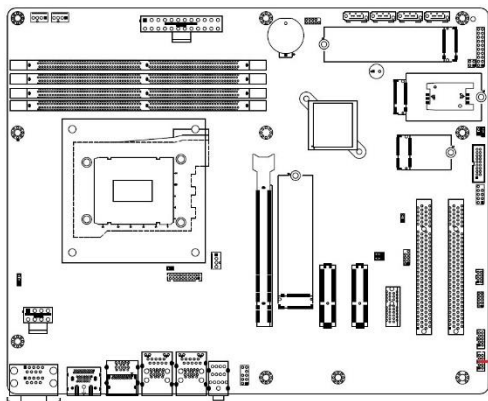

Pin	Signal Name	Pin	Signal Name
1	DCD#	2	SIN#
3	SOUT	4	DTR#
5	GND	6	DSR#
7	RTS#	8	CTS#
9	RI#	10	Key

Connector type: HK\_DF11-10S-PA66H

## 2.5.4 Digital I/O Connector (4 in, 4 out) (J5)

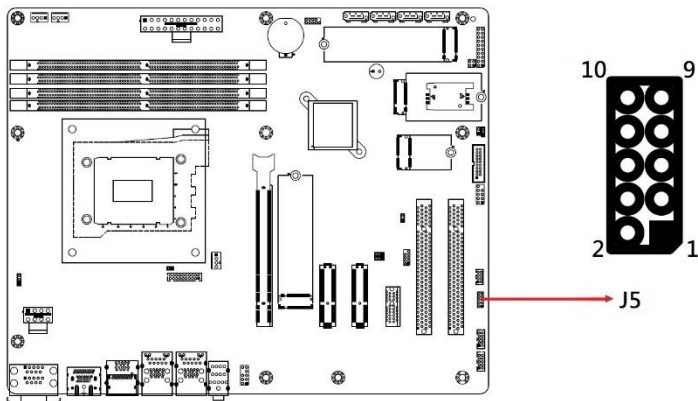

Pin	Signal Name	Pin	Signal Name
1	Ground	2	+5V
3	Out3	4	Out1
5	Out2	6	Out0
7	IN3	8	IN1
9	IN2	10	IN0

## 2.5.5 PS2 Keyboard/Mouse Connector (J7)

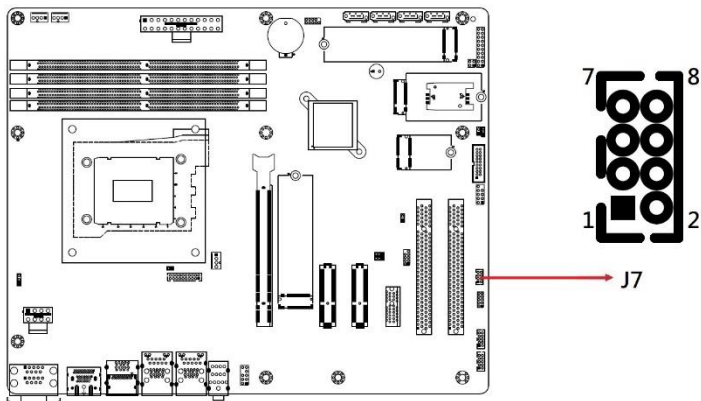

Pin	Signal Name	Pin	Signal Name
1	VCC	2	VCC
3	MDA	4	KBDA
5	MCL	6	KBCL#
7	GND	8	GND

Connector type: HK\_DF11-8S-PA66H



## 2.5.6 DVI-D Connector (J8)

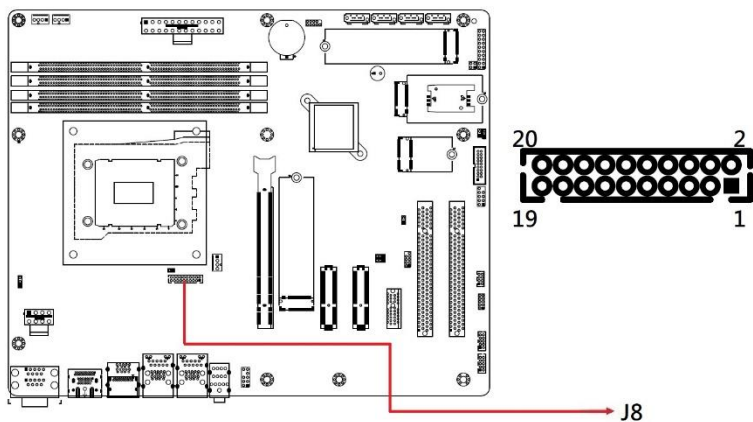

Pin	Signal Name	Pin	Signal Name
1	DATA1_P	2	DATA1_N
3	Ground	4	Ground
5	CLK_P	6	CLK_N
7	Ground	8	VCC
9	HPD	10	NC
11	DATA2_P	12	DATA2_N
13	Ground	14	Ground
15	DATA0_P	16	DATA0_N
17	NC	18	NC
19	SDA	20	SCL

Connector type: HK\_DF11-20S-PA66H

## 2.5.7 SATA Connectors (CN8, CN9, CN10, CN11)

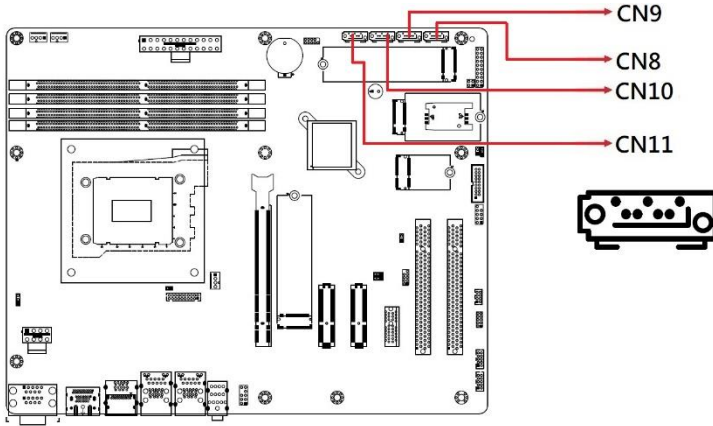

Pin	Signal Name
1	Ground
2	TX+
3	TX-
4	Ground
5	RX-
6	RX+
7	Ground

## 2.5.8 USB 2.0 Connector (J10)

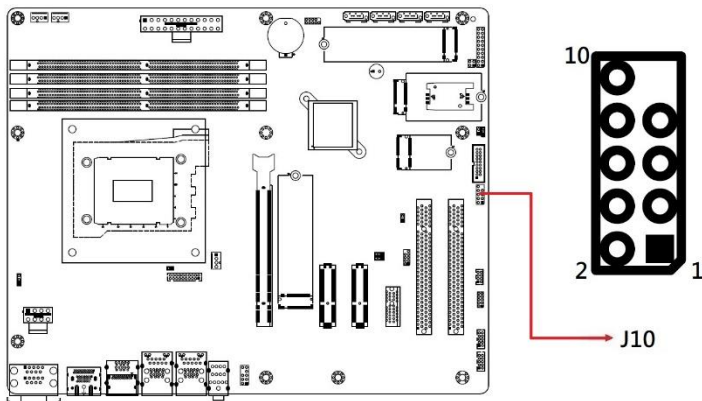

Pin	Signal Name	Pin	Signal Name
1	Vcc	2	VCC
3	D0-	4	D1-
5	D0+	6	D1+
7	Ground	8	Ground
9	Key	10	NC

## 2.5.9 USB 3.1 Connector (J11)

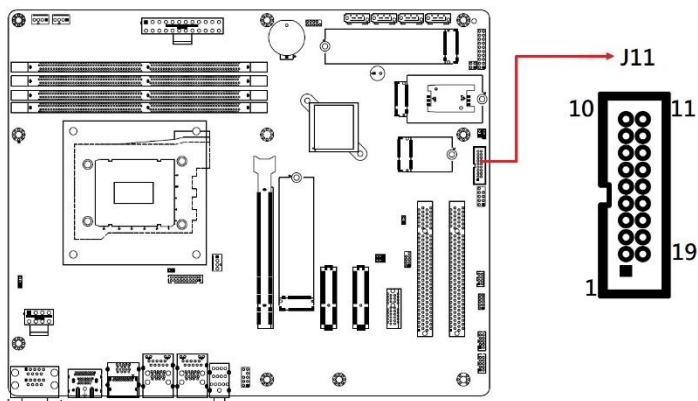

Pin	Signal Name	Pin	Signal Name
1	VCC	X	
2	P1_SSRX-	19	VCC
3	P1_SSRX+	18	P2_SSRX-
4	GND	17	P2_SSRX+
5	P1_SSTX-	16	GND
6	P1_SSTX+	15	P2_SSTX-
7	GND	14	P2_SSTX+
8	P1_U2_D-	13	GND
9	P1_U2_D+	12	P2_U2_D
10	NC	11	P2_U2_D+

Connector type: PINREX\_52X-40-20GU52

### 2.5.10 S3 Status Connector (J19)

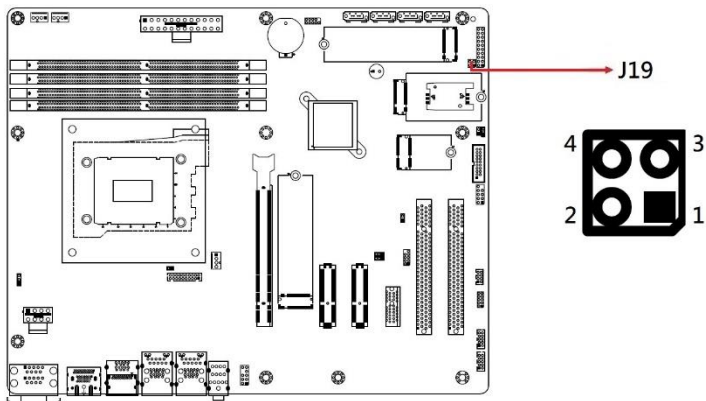

Pin	Signal Name	Pin	Signal Name
1	3VDUAL	2	Ground
3	VCC3	4	Ground

## 2.5.11 Front Panel Settings Connector (J20)

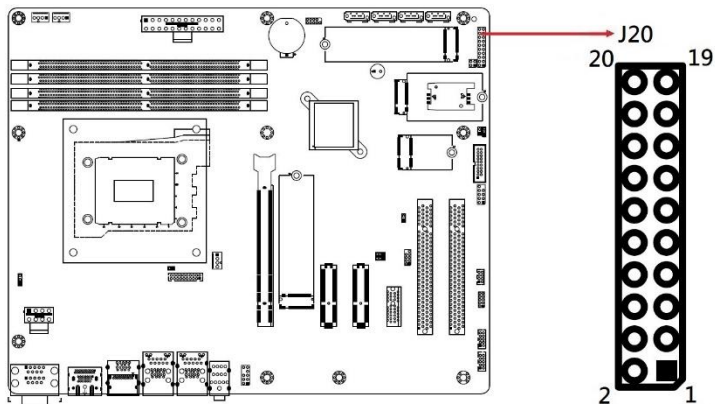

Pin	Signal Name	Pin	Signal Name
1	Power LED+	2	SPK
3	GND	4	NC
5	Power LED-	6	GND
7	NC	8	SPK(VCC)
9	GND	10	NC
11	GND	12	NC
13	Power BTN	14	Power BTN
15	NC	16	NC
17	Reset BTN	18	Reset BTN
19	HDD LED+	20	HDD LED-

### 2.5.12 24-pin ATX Power (J22)

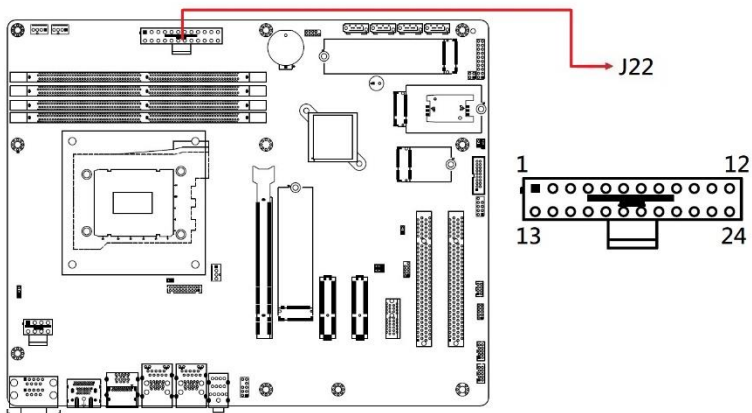

Pin	Signal Name	Pin	Signal Name
13	3.3V	1	3.3V
14	-12V	2	3.3V
15	Ground	3	Ground
16	PS-ON	4	+5V
17	Ground	5	Ground
18	Ground	6	+5V
19	Ground	7	Ground
20	NC	8	Power good
21	+5V	9	5VSB
22	+5V	10	+12V
23	+5V	11	+12V
24	Ground	12	3.3V

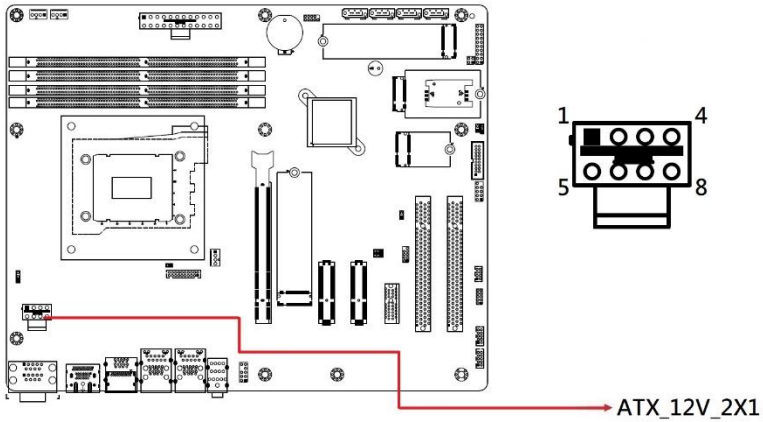
**2.5.13 AT 12V Power Connector (ATX\_12V\_2X1)**

Pin	Signal Name	Pin	Signal Name
1	Ground	5	+12V
2	Ground	6	+12V
3	Ground	7	+12V
4	Ground	8	+12V



## 2.5.14 CPU Fan Power Connector (CPU\_FAN1)

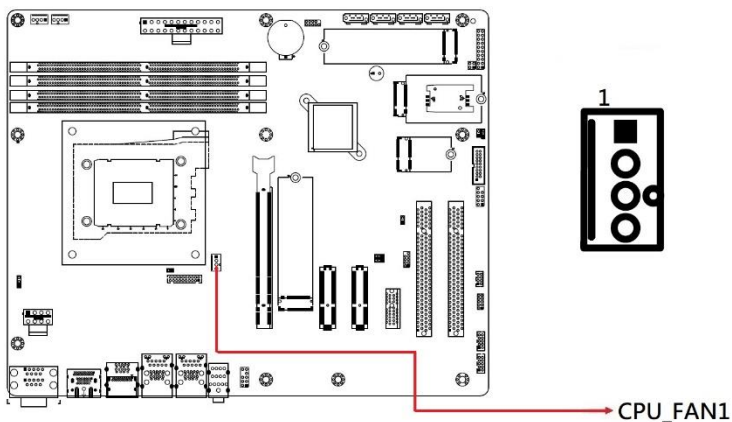

Pin	Signal Name
1	Ground
2	+12V
3	Rotation detection
4	Control

**Note: PWM Only**

## 2.5.15 System Fan Power Connector (SYS\_FAN1, SYS\_FAN2)

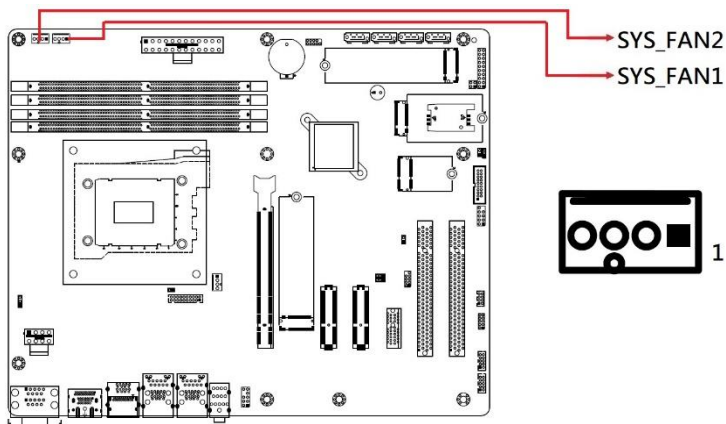

Pin	Signal Name
1	Ground
2	+12V
3	Rotation detection
4	Control

**Note: PWM Only**

# Chapter 3

## Drivers Installation

This chapter introduces installation of the following drivers:

- Intel® Chipset Software Installation Utility
- VGA Driver
- HD Audio Driver
- Intel® Trusted Execution Engine Drivers
- Intel® Serial I/O Drivers
- LAN Drivers

## 3.1 Introduction

This section describes the installation procedures for software and drivers. The software and drivers are included with the motherboard. If you find anything missing, please contact the distributor where you made the purchase. The contents of this section include the following:

---

**Note:** After installing your Windows operating system, you must install the Intel® Chipset Software Installation Utility first before proceeding with the drivers installation.

---

## 3.2 Intel® Chipset Software Installation Utility

The Intel® Chipset drivers should be installed first before the software drivers to install INF files for Plug & Play function for Intel chipset components. Follow the instructions below to complete the installation.

1. Insert the disk enclosed in the package. Click **Intel** on the left pane and then **Intel(R) AlderLake-S/RaptorLake-S Chipset Drivers**, and **Intel(R) Chipset Software Installation Utility** on the right pane.





2. When the *Welcome* screen to the Intel® Chipset Device Software appears, click **Next** to continue.

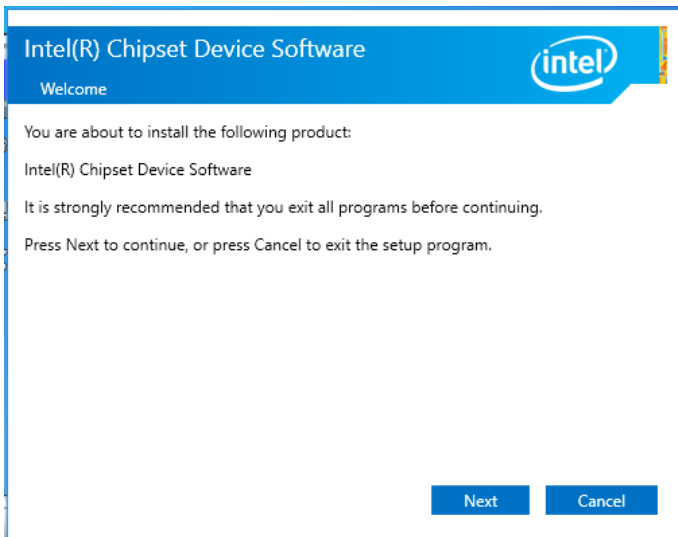

3. Accept the *License Agreement* and click **Accept**.
4. On the *Readme File Information* screen, click **Install**.
5. When the driver has been completely installed, click **Finish** to complete the setup process.

## 3.3 VGA Driver Installation

1. Click **Intel** on the left pane and then **Intel(R) AlderLake-S/ RaptorLake-S Chipset Drivers**, and **Intel(R) HD Graphics Driver** on the right pane.

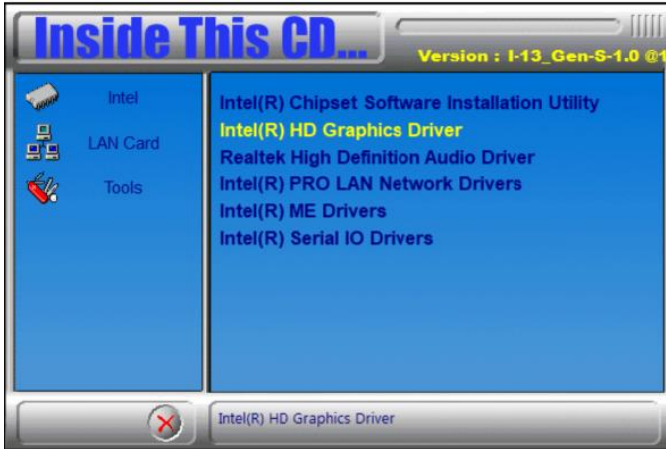

2. When the **Intel Graphics Driver Installer** screen appears, click **Begin installation**.



3. Click **I agree** to accept the INTEL SOFTWARE LICENSE AGREEMENT.
4. In the Pre-Install stage, "The installer will install the following components:
  - Intel® Graphics Driver
  - Intel® Graphics Command CenterClick **Start** to start installing the new graphics driver.
5. The next screen will indicate that the new graphics driver is being installed. When the message "**Installation complete!**" appears, restart your system in order to apply the driver changes.

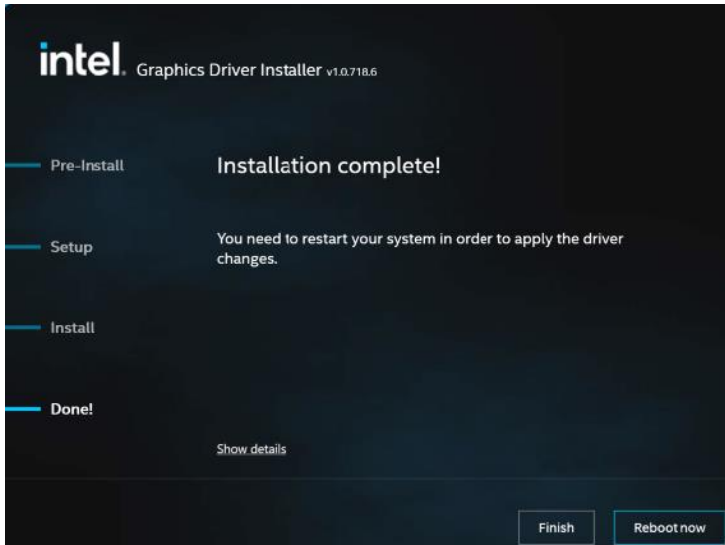

## 3.4 Realtek HD Audio Driver Installation

1. Click **Intel** on the left pane and then **Intel(R) AlderLake-S/ RaptorLake-S Chipset Drivers**, and **Realtek High Definition Audio Driver** on the right pane.



2. On the *Welcome* screen of the InstallShield Wizard, click **Next** to install the drivers.

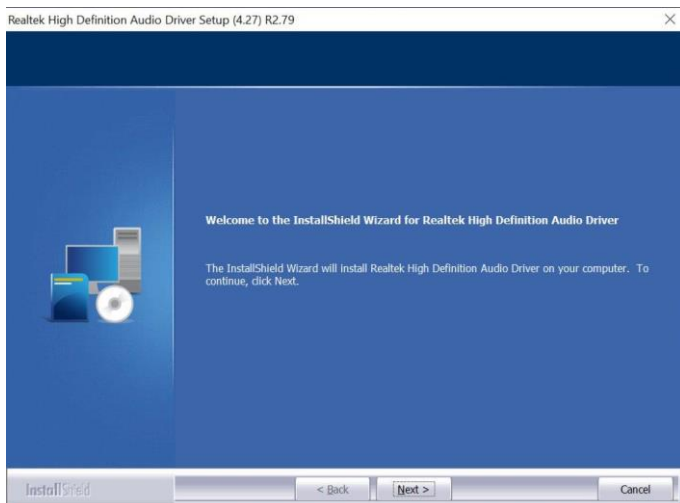

3. When the audio driver has been successfully, click **Finish** to restart the computer.



### 3.5 Intel® ME Drivers Installation

1. Click **Intel** on the left pane and then **Intel(R) AlderLake-S/ RaptorLake-S Chipset Drivers**, and **Intel(R) ME Drivers** on the right pane.



2. When the *Welcome* screen to the **Intel® Management Engine Components** appears, click **Next**.
3. Accept the terms in the License Agreement and click **Next**.
4. On the next screen, click **Next** to install to the default folder.
5. Click **Finish** when the necessary components have been successfully installed.

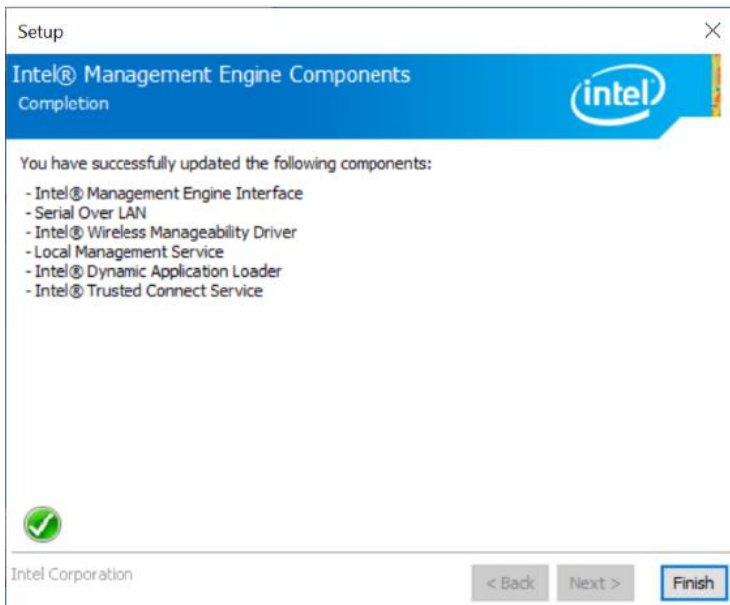

## 3.6 Intel® Serial IO Drivers Installation

1. Click **Intel** on the left pane and then **Intel(R) AlderLake-S/RaptorLake-S Chipset Drivers**, and **Intel(R) Serial IO Drivers** on the right pane.



2. When the *Welcome* screen to the Intel® Serial IO appears, click **Next**.

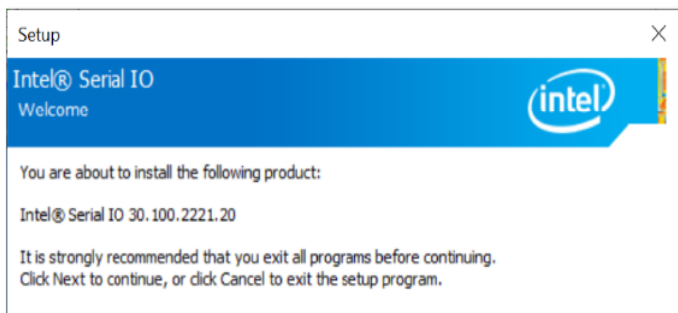

3. Accept the terms in the license agreement and click **Next**.
4. On the **Readme File Information** and **Confirmation** screens, click **Next**.
5. Click **Finish** when the **Completion** screen appears.

### 3.7 LAN Drivers Installation

1. Click **LAN Card** on the left pane and then **Intel PRO LAN Network Drivers** on the right pane.

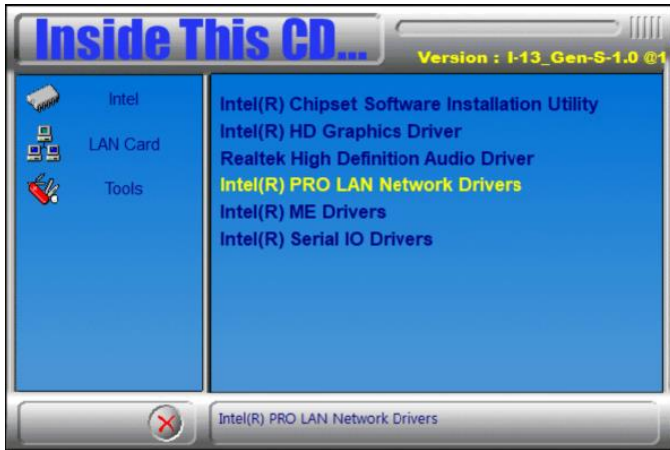

2. Click **Intel Drivers and Software**.

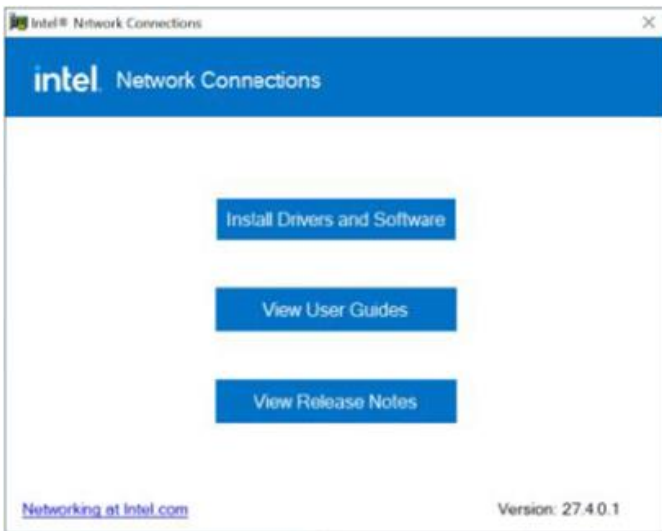

## iBASE

- When the *Welcome to the install wizard for Intel(R) Network Connection* screen appears, click **Next**. On the next screen, accept the terms in the License Agreement and click **Next**.
- On the *Setup Options* screen, select the program features you want installed. Then click **Next** to continue.

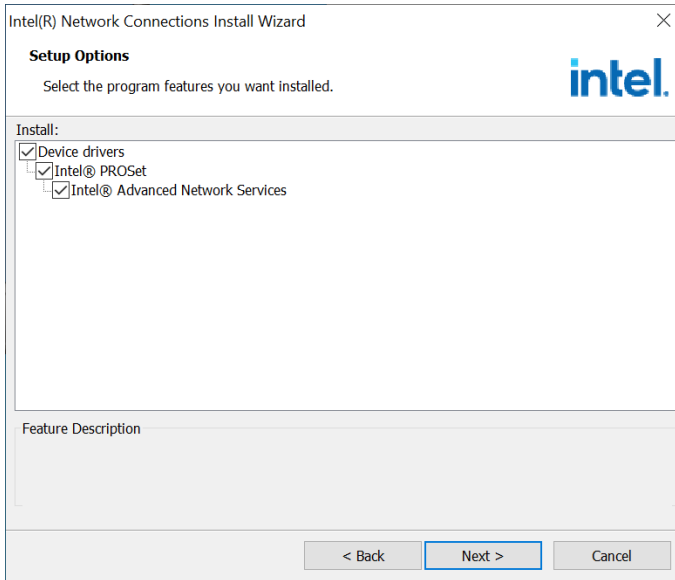

- On the *Ready to Install the Program* screen, click **Install** to begin the installation.
- When the *Install wizard Completed* screen appears, click **Finish**.

# Chapter 4

## BIOS Setup

This chapter describes the different settings available in the AMI BIOS that comes with the board. The topics covered in this chapter are as follows:

- Main Settings
- Advanced Settings
- Chipset Settings
- Security Settings
- Boot Settings
- Save & Exit

## 4.1 Introduction

The BIOS (Basic Input/Output System) installed in the ROM of your computer system supports Intel® processors. The BIOS provides critical low-level support for standard devices such as disk drives, serial ports and parallel ports. It also provides password protection as well as special support for detailed fine-tuning of the chipset controlling the entire system.

## 4.2 BIOS Setup

The BIOS provides a Setup utility program for specifying the system configurations and settings. The BIOS ROM of the system stores the Setup utility. When you turn on the computer, the BIOS is immediately activated. Press the <Del> key immediately allows you to enter the Setup utility. If you are a little bit late pressing the <Del> key, POST (Power On Self Test) will continue with its test routines, thus preventing you from invoking the Setup.

If you still need to enter Setup, restart the system by pressing the "Reset" button or simultaneously pressing the <Ctrl>, <Alt> and <Delete> keys. You can also restart by turning the system Off and back On again.

The following message will appear on the screen:

```
Press <DEL> to Enter Setup
```

In general, press the arrow keys to highlight items, <Enter> to select, the <PgUp> and <PgDn> keys to change entries, <F1> for help, and <Esc> to quit.

When you enter the BIOS Setup utility, the *Main Menu* screen will appear on the screen. The Main Menu allows you to select from various setup functions and exit choices.

---

**Warning:** It is strongly recommended that you avoid making any changes to the chipset defaults.

These defaults have been carefully chosen by both AMI and your system manufacturer to provide the absolute maximum performance and reliability. Changing the defaults could make the system unstable and crash in some cases.

---

## 4.3 Main Settings



BIOS Setting	Description
System Date	Sets the date. Use the <Tab> key to switch between the data elements.
System Time	Set the time. Use the <Tab> key to switch between the data elements.

## 4.4 Advanced Settings

This section allows you to configure, improve your system and allows you to set up some system features according to your preference.

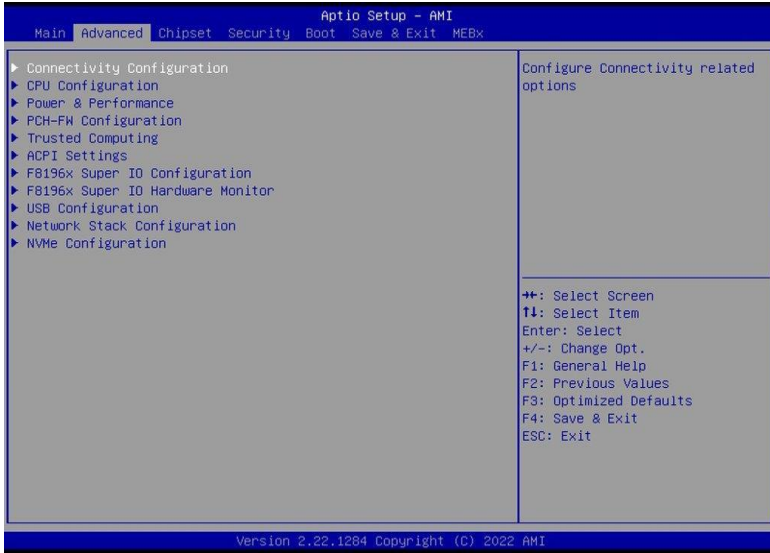



### 4.4.1 Connectivity Configuration

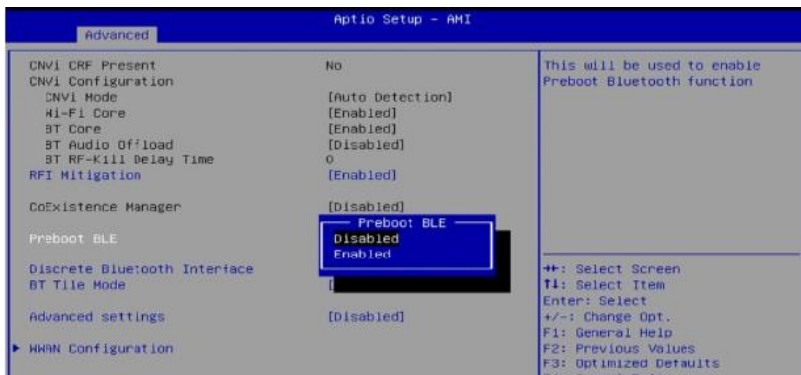

BIOS Setting	Description
RFI Mitigation	This is an option intended to enable/disable DDR-RFIM feature for Connectivity
Preboot BLE	This will be used to enable Preboot Bluetooth function.
Discrete Bluetooth Interface	Seriallo UART0 needs to be enabled to select BT interace.
BT Tile Mode	Enable/Disable Tile.
Advanced Settings	Configure ACPI objects for wireless devices.
WWAN Configuration	Configure WWAN related options.
WWAN Device	Select the M.2 WWAN Device options to enable 4G – 7360/7560 (Intel), 5G- M80 (MediaTek) Modems



## 4.4.2 CPU Configuration

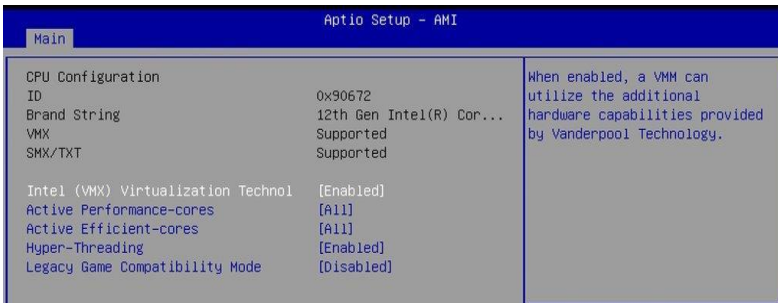

BIOS Setting	Description
Intel (VMX) Virtualization Technology	When enable, a VMM can utilize the additional hardware capabilities provided by Vanderpool Technology.
Active Efficient-cores Active Efficient-cores	Number of P-cores to enable in each processor package. Note: Number of Cores and E-cores are looked at together. When both are (0,0), Pcode will enable all cores
Hyper-Threading	Enable or disable Hyper-Threading Technology.
Legacy Game Compatibility Mode	When enable, pressing the scroll lock key will toggle the Efficient-cores between being parked when Scroll Lock LED is on and un-parked when LED is off.

### 4.4.3 Power & Performance

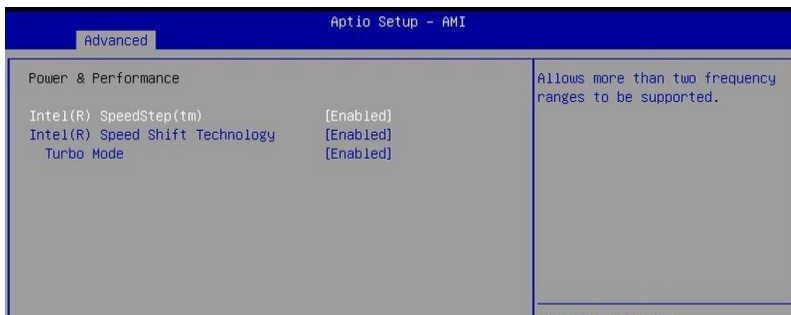

BIOS Setting	Description
Intel(R) SpeedStep(tm)	Allows more than two frequency ranges to be supported.
Intel(R) Speed Shift Technology	Enable/Disable Intel(R) Speed Shift Technology support. Enabling will expose the CPPC v2 interface to allow for hardware controlled P-states.
Turbo Mode	Enable/Disable processor Turbo Mode (requires EMTTM enabled too). AUTO means enabled.

## 4.4.4 PCH-FW Configuration

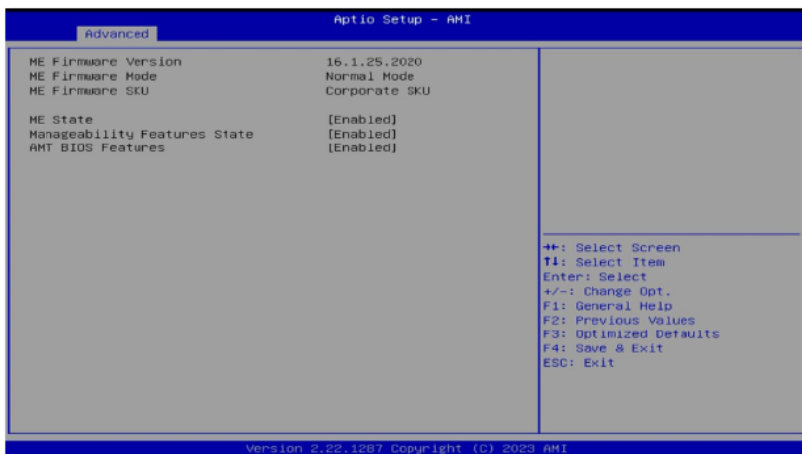

BIOS Setting	Description
ME State	When Disabled ME will be put into ME Temporarily Disabled Mode.
Manageability Features State	Enable/Disable Intel(R) Manageability features. <b>Note:</b> This option disables/enables Manageability Features support in FW. To disable support platform must be in an unprovisioned state first.
AMT BIOS Features	When disabled AMT BIOS Features are no longer supported and user is no longer able to access MEBx Setup. <b>Note:</b> This option does not disable Manageability Features in FW.

### 4.4.5 Trusted Computing

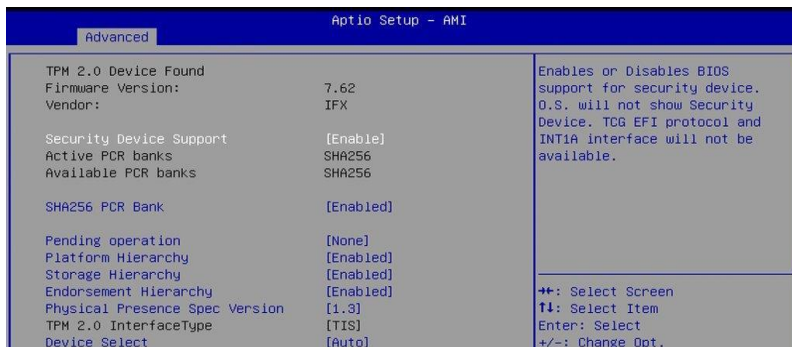

BIOS Setting	Description
Security Device Support	Enables / Disables BIOS support for security device. OS will not show security device. TCG EFI protocol and INTIA interface will not be available.
SHA256 PCR Bank	Enables / Disables SHA256 PCR Bank.
Pending operation	Schedule an operation for the security device. Note: Your computer will reboot during restart in order to change state of security device.
Platform Hierarchy	Enables / Disables platform hierarchy.
Storage Hierarchy	Enables / Disables storage hierarchy.
Endorsement Hierarchy	Enables / Disables endorsement hierarchy.
Physical Presence Spec Version	Selects to show the PPI Spec Version (1.2 or 1.3) that the OS supports. <b>Note:</b> Some HCK tests might not support 1.3.
Device Select	<ul style="list-style-type: none"> <li>• <b>TPM 1.2</b> will restrict support to TPM 1.2 devices only.</li> <li>• <b>TPM 2.0</b> will restrict support to TPM 2.0 devices only.</li> <li>• <b>Auto</b> will support both with the default being set to TPM 2.0 devices if not found, and TPM 1.2 device will be enumerated.</li> </ul>

## 4.4.6 ACPI Settings

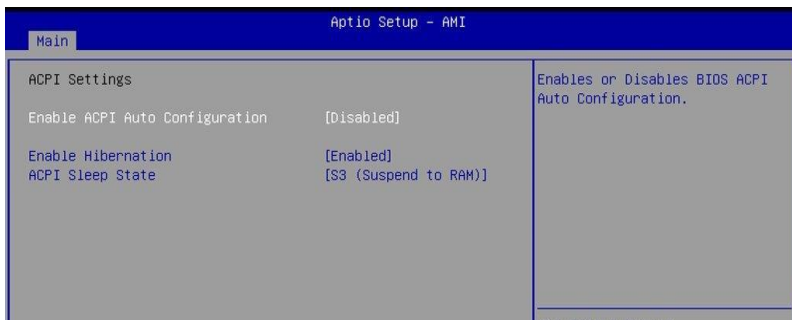

BIOS Setting	Description
Enable ACPI Auto Configuration	Enables or Disables BIOS ACPI Auto Configuration
Enable Hibernation	Enables / Disables the system ability to hibernate (OS/S4 Sleep State). This option may be not effective with some OS.
ACPI Sleep State	Selects an ACPI sleep state where the system will enter when the Suspend button is pressed. Options: Suspend Disabled, S3 (Suspend to RAM)

## 4.4.7 F8196x Super IO Hardware Monitor



BIOS Setting	Description
Power Failure	Options: Always on, Always off
Serial Port Configuration	Sets parameters of Serial Ports. Enables / Disables the serial port and select an optimal setting for the Super IO device.

### 4.4.7.1. Serial Port 1 Configuration

BIOS Setting	Description
Serial Port	Enables / Disables the serial port.
Change Settings	Selects an optimal settings for Super I/O device. <ul style="list-style-type: none"> <li>• Auto</li> <li>• IO = 3F8h; IRQ = 4</li> <li>• IO = 3F8h; IRQ = 3, 4, 5, 6, 7, 9, 10, 11, 12</li> <li>• IO = 2F8h; IRQ = 3, 4, 5, 6, 7, 9, 10, 11, 12</li> <li>• IO = 3E8h; IRQ = 3, 4, 5, 6, 7, 9, 10, 11, 12</li> <li>• IO = 2E8h; IRQ = 3, 4, 5, 6, 7, 9, 10, 11, 12</li> </ul>
Device Mode	Changes the serial port mode. <ul style="list-style-type: none"> <li>• RS232</li> <li>• RS485 TX Low Active</li> <li>• RS485 with Termination TX Low Active</li> <li>• RS422</li> <li>• RS422 with Termination</li> </ul>

## 4.4.7.2. Serial Port 2 Configuration

BIOS Setting	Description
Serial Port	Enables / Disables the serial port.
Change Settings	<p>Selects an optimal settings for Super I/O device. Options:</p> <ul style="list-style-type: none"> <li>• Auto</li> <li>• IO = 2F8h; IRQ = 3</li> <li>• IO = 3F8h; IRQ = 3, 4, 5, 6, 7, 9, 10, 11, 12</li> <li>• IO = 2F8h; IRQ = 3, 4, 5, 6, 7, 9, 10, 11, 12</li> <li>• IO = 3E8h; IRQ = 3, 4, 5, 6, 7, 9, 10, 11, 12</li> <li>• IO = 2E8h; IRQ = 3, 4, 5, 6, 7, 9, 10, 11, 12</li> </ul>
Device Mode	<p>Changes the serial port mode. Options:</p> <ul style="list-style-type: none"> <li>• RS232</li> <li>• RS485 TX Low Active</li> <li>• RS485 with Termination TX Low Active</li> <li>• RS422</li> <li>• RS422 with Termination</li> </ul>

## 4.4.7.3. Serial Port 3 Configuration

BIOS Setting	Description
Serial Port	Enables / Disables the serial port.
Change Settings	<p>Selects an optimal settings for Super I/O device.</p> <ul style="list-style-type: none"> <li>• Auto</li> <li>• IO = 3E8h; IRQ = 7</li> <li>• IO = 3E8h; IRQ = 3, 4, 5, 6, 7, 9, 10, 11, 12</li> <li>• IO = 2E8h; IRQ = 3, 4, 5, 6, 7, 9, 10, 11, 12</li> <li>• IO = 2F0h; IRQ = 3, 4, 5, 6, 7, 9, 10, 11, 12</li> <li>• IO = 2E0h; IRQ = 3, 4, 5, 6, 7, 9, 10, 11, 12</li> </ul>

## 4.4.7.4. Serial Port 4 Configuration

BIOS Setting	Description
Serial Port	Enables / Disables the serial port.
Change Settings	<p>Selects an optimal settings for Super I/O device.</p> <ul style="list-style-type: none"> <li>• Auto</li> <li>• IO = 2E8h; IRQ = 7</li> <li>• IO = 3E8h; IRQ = 3, 4, 5, 6, 7, 9, 10, 11, 12</li> <li>• IO = 2E8h; IRQ = 3, 4, 5, 6, 7, 9, 10, 11, 12</li> <li>• IO = 2F0h; IRQ = 3, 4, 5, 6, 7, 9, 10, 11, 12</li> <li>• IO = 2E0h; IRQ = 3, 4, 5, 6, 7, 9, 10, 11, 12</li> </ul>



### 4.4.8 F8196x Super IO Hardware Monitor

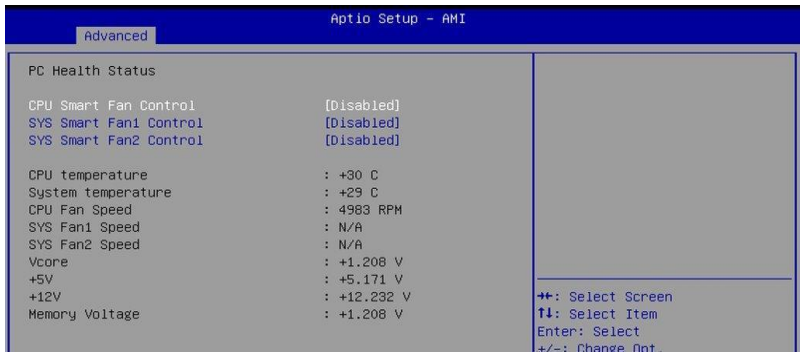

BIOS Setting	Description
CPU Smart Fan Control	Enables / Disables the CPU smart fan feature. Options: Disabled / 50 °C / 60 °C / 70 °C / 80 °C
System Smart Fan Control	Enables / Disables the system smart fan feature. Options: Disabled / 50 °C / 60 °C / 70 °C / 80 °C
Temperatures / Voltages	These fields are the parameters of the hardware monitoring function feature of the motherboard. The values are read-only values as monitored by the system and show the PC health status.

## 4.4.9 USB Configuration

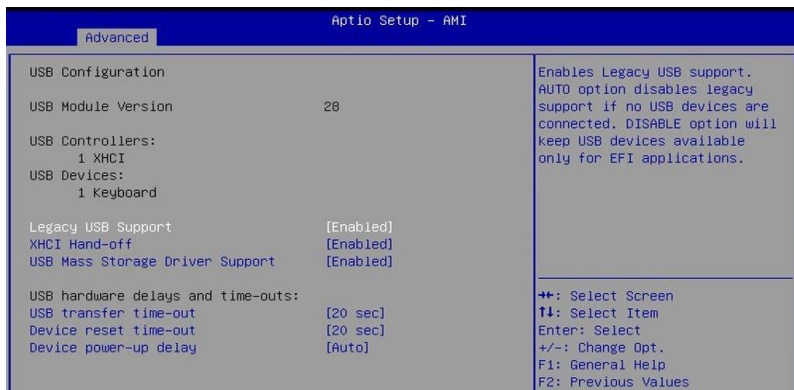

BIOS Setting	Description
Legacy USB Support	<ul style="list-style-type: none"> <li>• <b>Enabled</b> enables Legacy USB support.</li> <li>• <b>Auto</b> disables legacy support if there is no USB device connected.</li> <li>• <b>Disabled</b> keeps USB devices available only for EFI applications.</li> </ul>
XHCI Hand-off	This is a workaround for OSeS without XHCI hand-off support. The XHCI ownership change should be claimed by XHCI driver.
USB Mass Storage Driver Support	Enables / Disables the support for USB mass storage driver.
USB Transfer time-out	The time-out value (1 / 5 10 / 20 secs) for Control, Bulk, and Interrupt transfers.
Device reset time-out	Gives seconds (10 / 20 / 30 / 40 secs) to delay execution of Start Unit command to USB mass storage device.
Device power-up delay	The maximum time the device will take before it properly reports itself to the Host Controller. <b>Auto</b> uses default value for a Root port it is 100ms. But for a Hub port, the delay is taken from Hub descriptor.

### 4.4.10 Network Stack Configuration



BIOS Setting	Description
Network Stack	Enables / Disables UEFI Network Stack.
IPv4 PXE Support	Enables / Disables IPv4 PXE Boot Support. If disabled, Ipv4 PXE boot option will not be created.
IPv4 HTTP Support	Enables / Disables IPv4 HTTP Boot Support. If disabled, Ipv4 HTTP boot option will not be created.
IPv6 PXE Support	Enables / Disables IPv6 PXE Boot Support. If disabled, Ipv4 PXE boot option will not be created.
IPv6 HTTP Support	Enables / Disables IPv6 HTTP Boot Support. If disabled, Ipv4 HTTP boot option will not be created.
PXE boot wait time	Assigns a period of time to press ESC key to abort the PXE boot.
Media detect count	Assigns a number of times to check the presence of media.

## 4.5 Chipset Settings

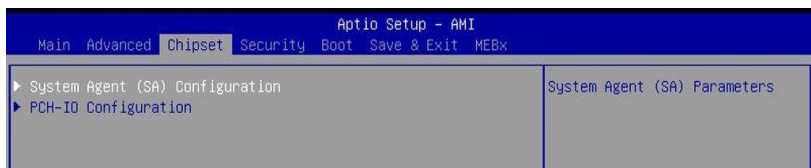

BIOS Setting	Description
System Agent (SA) Configuration	System Agent (SA) parameters
PCH-IO Configuration	PCH parameters

### 4.5.1 System Agent (SA) Configuration

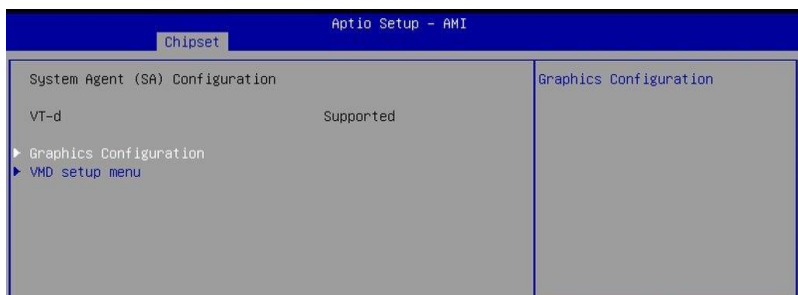

BIOS Setting	Description
Graphics Configuration	Configures the graphics settings.
VMD setup meu	VMD configuration settings.

### 4.5.1.1. Graphics Configuration

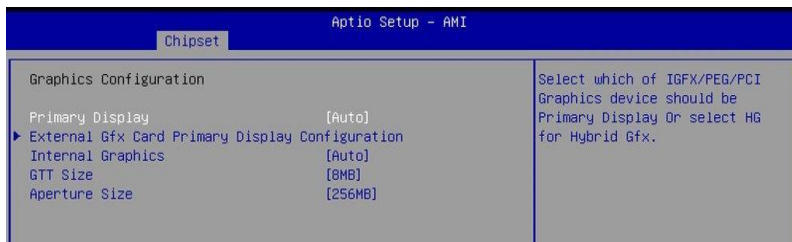

BIOS Setting	Description
Primary Display	Select which of IGFX/PEG/PCI Graphics device should be primary display or select HG for Hybrid Gfx. Options: Auto, IGFX, PEG Slot, PCH PCI, HG
External Gfx Card Primary Display Configuration	External Gfx Card Primary Display Configuration
Primary PEG	Select PEG0/PEG1/PEG3 Graphics device should be Primary PEG.
Primary PCIE	Select the graphics device as Primary PCIE.
Internal Graphics	Keep IGFX enabled based on the setup options. Options: Auto, Disabled, Enabled
GTT Size	Sets the GTT size as 2 MB, 4 MB, or 8 MB.
Aperture Size	Sets the aperture size as 128 MB, 256 MB, 512 MB, 1024 MB or 2048 MB. <b>Note:</b> Above 4 GB MMIO BIOS assignment is automatically enabled when selecting 2048 MB aperture. To use this feature, disable CSM support.



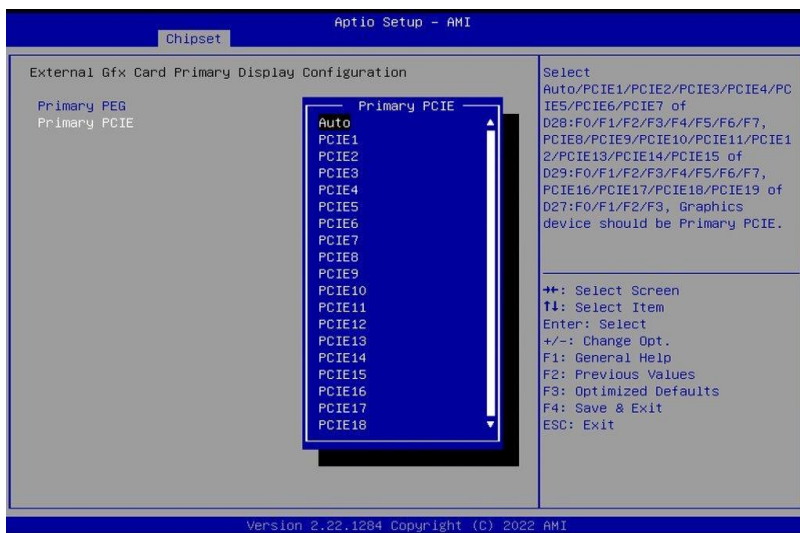

BIOS Setting	Description
GTT Size	Sets the GTT size as 2 MB, 4 MB, or 8 MB.
Aperture Size	<p>Sets the aperture size as 128 MB, 256 MB, 512 MB, 1024 MB or 2048 MB.</p> <p><b>Note:</b> Above 4 GB MMIO BIOS assignment is automatically enabled when selecting 2048 MB aperture. To use this feature, disable CSM support.</p>

## 4.5.2 PCH-IO Configuration



BIOS Setting	Description
PCH-IO Configuration	PCH Parameters
SATA Configuration	SATA Devices Options Settings

### 4.5.2.1. SATA Configuration:

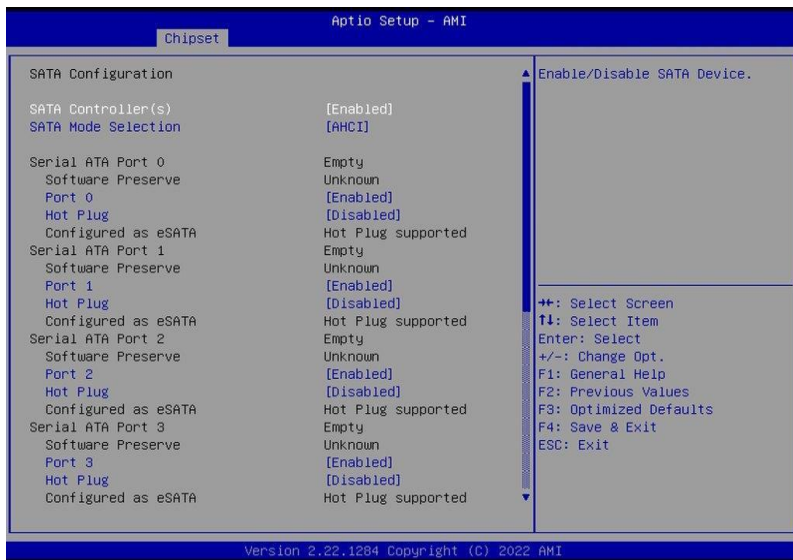

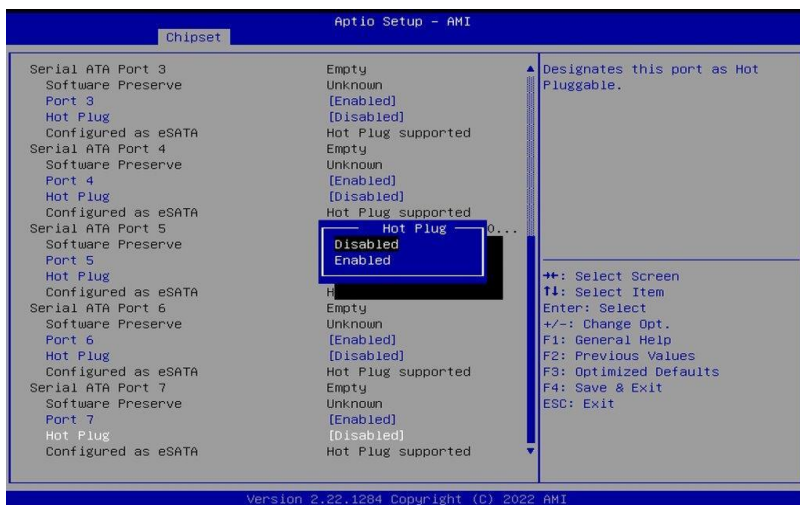

BIOS Setting	Description
SATA Controller(s)	Enables / Disables the SATA device.
SATA Mode Selection	Determines how SATA controller(s) operate.
Serial ATA Ports	Enables / Disables SATA ports.
Hot Plug	Designates the port as Hot Pluggable.



## 4.6 Security Settings

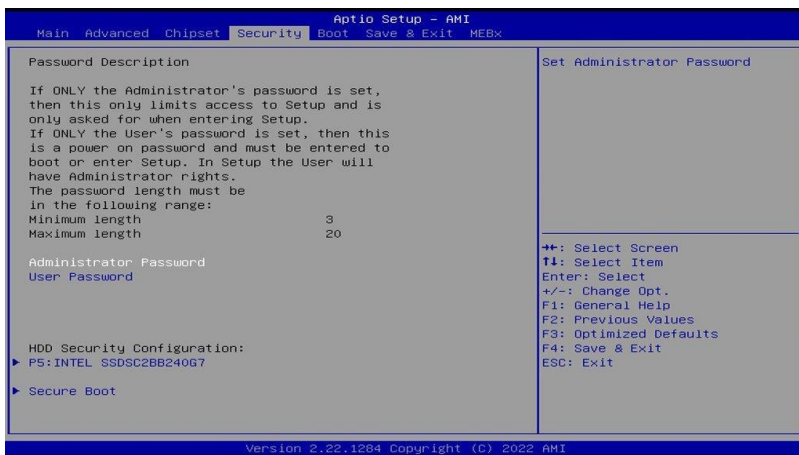

BIOS Setting	Description
Administrator Password	Sets an administrator password for the setup utility.
User Password	Sets a user password.
Secure Boot	Configures Secure Boot.

### 4.6.1 Secure Boot

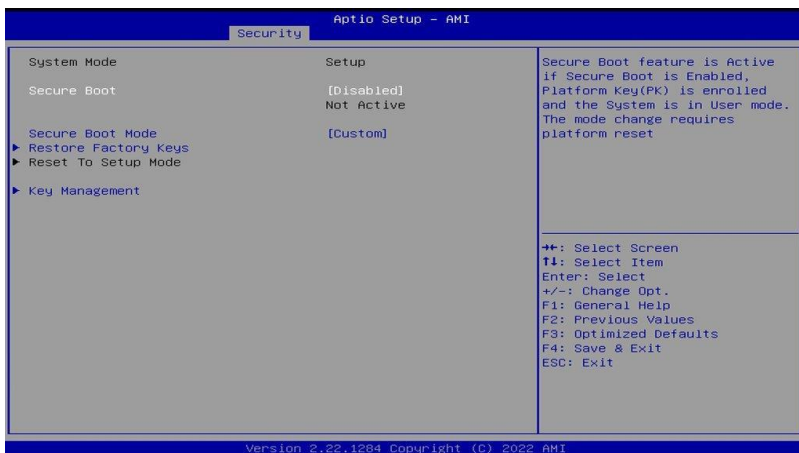

BIOS Setting	Description
Secure Boot	Secure Boot feature is Active if Secure Boot is enabled. Platform Key (PK) Is enrolled and the system is in User mode. The mode change requires platform reset.
BIOS Setting	Description
Secure Boot Mode	Secure Boot mode options: Standard or Custom.  In Custom mode, Secure Boot policy variables can be configured by a physically present user without full authentication.
Restore Factory Keys	Forces system to user mode. Install factory default Secure Boot key databases.
Key Management	Enables expert users to modify Secure Boot Policy variables without full authentication.

## 4.6.1.1. Key Management

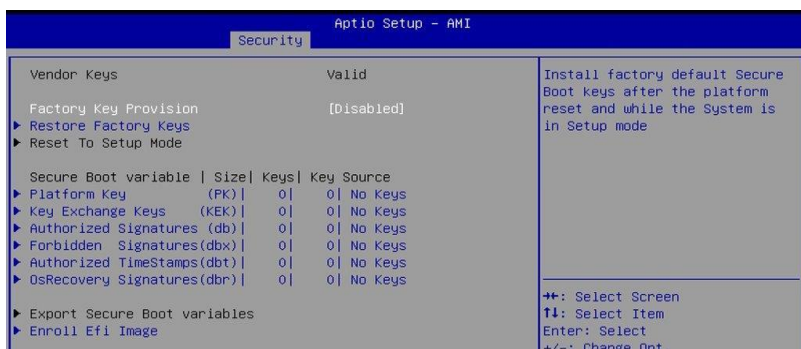

BIOS Setting	Description
Factory Key Provision	Install factory default Secure Boot keys after the platform reset and while the system is in Setup mode.
Restore Factory Keys	Forces system to use mode. Install factory default Secure Boot Key databases.
Enroll Efi Image	Allow the image to run in Secure Boot mode. Enroll SHA256 Hash certificate of a PE image into Authorized Signature Database (db).

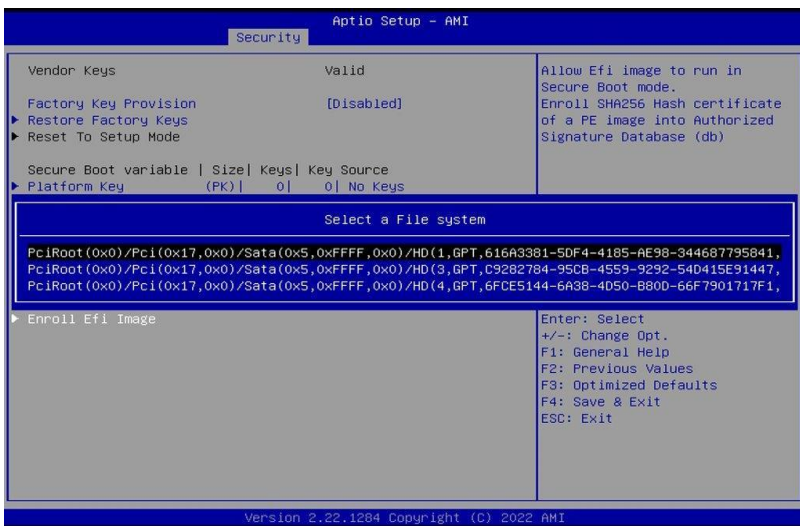
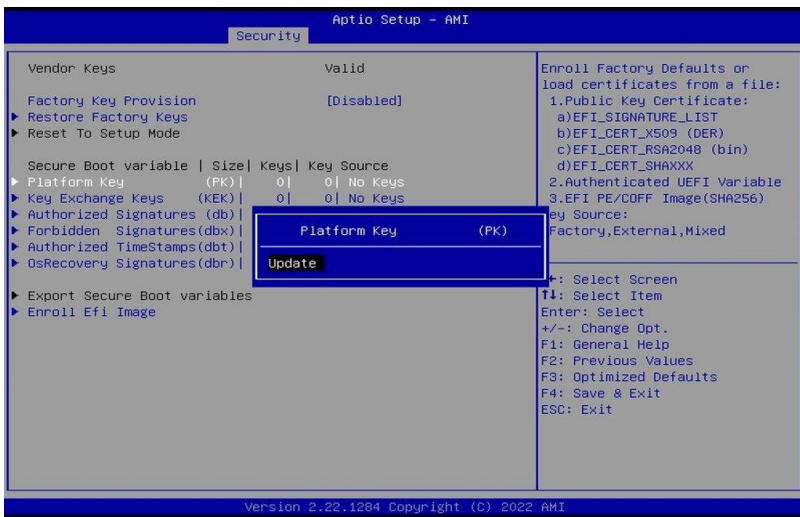

## 4.7 Boot Settings

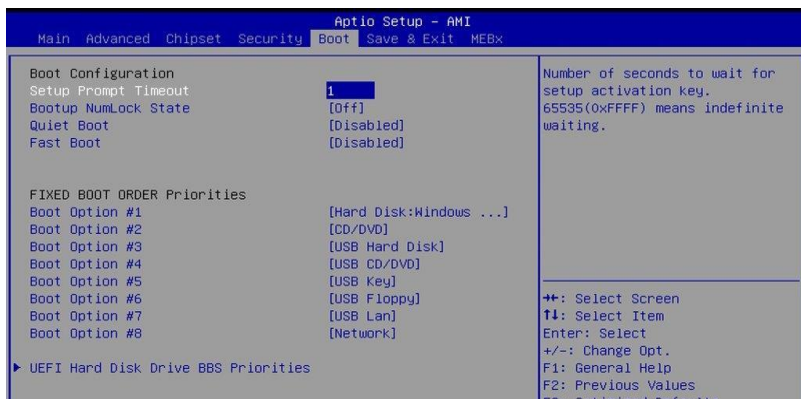

BIOS Setting	Description
Setup Prompt Timeout	Number of seconds to wait for setup activation key. 65535(0xFFFF) means indefinite waiting.
Bootup NumLock State	Selects the keyboard NumLock state.
Quiet Boot	Enables / Disables Quiet Boot option.
Boot mode select	Selects a Boot mode, Legacy / UEFI.
Boot Option Priorities	Sets the system boot order.

## 4.8 Save & Exit Settings

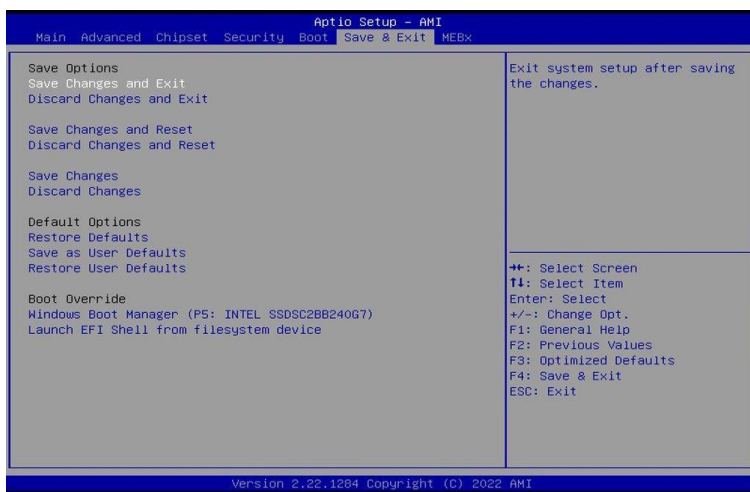

BIOS Setting	Description
Save Changes and Exit	Exits system setup after saving the changes.
Discard Changes and Exit	Exits system setup without saving any changes.
Save Changes and Reset	Resets the system after saving the changes.
Discard Changes and Reset	Resets system setup without saving any changes.
Save Changes	Saves changes done so far to any of the setup options.
Discard Changes	Discards changes done so far to any of the setup options.
Restore Defaults	Restores / Loads defaults values for all the setup options.
Save as User Defaults	Saves the changes done so far as User Defaults.
Restore User Defaults	Restores the user defaults to all the setup options.

This page is intentionally left blank.

# Appendix

This section provides the mapping addresses of peripheral devices and the sample code of watchdog timer configuration.

## A. I/O Port Address Map

Each peripheral device in the system is assigned a set of I/O port addresses which also becomes the identity of the device. The following table lists the I/O port addresses used.

Address	Device Description
0x00000A00-0x00000A0F	Motherboard resources
0x00000A10-0x00000A1F	Motherboard resources
0x00000A20-0x00000A2F	Motherboard resources
0x0000002E-0x0000002F	Motherboard resources
0x0000004E-0x0000004F	Motherboard resources
0x00000061-0x00000061	Motherboard resources
0x00000063-0x00000063	Motherboard resources
0x00000065-0x00000065	Motherboard resources
0x00000067-0x00000067	Motherboard resources
0x00000070-0x00000070	Motherboard resources
0x00000080-0x00000080	Motherboard resources
0x00000092-0x00000092	Motherboard resources
0x000000B2-0x000000B3	Motherboard resources
0x00000680-0x0000069F	Motherboard resources
0x0000164E-0x0000164F	Motherboard resources
0x00001854-0x00001857	Motherboard resources
0x00000020-0x00000021	Programmable interrupt controller
0x00000024-0x00000025	Programmable interrupt controller
0x00000028-0x00000029	Programmable interrupt controller
0x0000002C-0x0000002D	Programmable interrupt controller
0x00000030-0x00000031	Programmable interrupt controller
0x00000034-0x00000035	Programmable interrupt controller
0x00000038-0x00000039	Programmable interrupt controller
0x0000003C-0x0000003D	Programmable interrupt controller
0x000000A0-0x000000A1	Programmable interrupt controller



Address	Device Description
0x000000A4-0x000000A5	Programmable interrupt controller
0x000000A8-0x000000A9	Programmable interrupt controller
0x000000AC-0x000000AD	Programmable interrupt controller
0x000000B0-0x000000B1	Programmable interrupt controller
0x000000B4-0x000000B5	Programmable interrupt controller
0x000000B8-0x000000B9	Programmable interrupt controller
0x000000BC-0x000000BD	Programmable interrupt controller
0x000004D0-0x000004D1	Programmable interrupt controller
0x000003F8-0x000003FF	Communications Port (COM1)
0x000002F8-0x000002FF	Communications Port (COM2)
0x000003E8-0x000003EF	Communications Port (COM3)
0x000002E8-0x000002EF	Communications Port (COM4)
0x00003090-0x00003097	Standard SATA AHCI Controller
0x00003080-0x00003083	Standard SATA AHCI Controller
0x00003060-0x0000307F	Standard SATA AHCI Controller
0x0000FFF8-0x0000FFFF	Intel(R) Active Management Technology - SOL (COM5)
0x00000000-0x00000CF7	PCI Express Root Complex
0x00000D00-0x0000FFFF	PCI Express Root Complex
0x00000040-0x00000043	System timer
0x00000050-0x00000053	System timer
0x00002000-0x000020FE	Motherboard resources
0x00000060-0x00000060	Standard PS/2 Keyboard
0x00000064-0x00000064	Standard PS/2 Keyboard
0x00003000-0x0000303F	Intel(R) UHD Graphics 770

## B. Interrupt Request Lines (IRQ)

Peripheral devices use interrupt request lines to notify CPU for the service required. The following table shows the IRQ used by the devices on board.

Level	Function
IRQ 0	System timer
IRQ 1	Standard PS/2 Mouse
IRQ 3	Communications Port (COM2)
IRQ 4	Communications Port (COM1)
IRQ 4	PCI Data Acquisition and Signal Processing Controller
IRQ 5	Communications Port (COM3)
IRQ 7	Communications Port (COM4)
IRQ 8	High precision event timer
IRQ 12	Microsoft PS/2 Mouse
IRQ 14	Intel(R) Serial IO GPIO Host Controller - INTC1056
IRQ 16	Intel(R) Serial IO UART Host Controller - 7AA8
IRQ 17	High Definition Audio Controller
IRQ 19	Intel(R) Active Management Technology - SOL (COM5)
IRQ 27	Intel(R) Serial IO I2C Host Controller - 7ACC
IRQ 29	Intel(R) Serial IO I2C Host Controller - 7ACE
IRQ 31	Intel(R) Serial IO I2C Host Controller - 7AFC
IRQ 32	Intel(R) Serial IO I2C Host Controller - 7AFD
IRQ 37	Intel(R) Serial IO SPI Host Controller - 7AAB
IRQ 43	Intel(R) Serial IO I2C Host Controller - 7ACF
IRQ 109	Trusted Platform Module 2.0
IRQ 55 ~ IRQ 204	Microsoft ACPI-Compliant System
IRQ 256 ~ IRQ 511	Microsoft ACPI-Compliant System

Level	Function
IRQ 4294967254~70	Intel(R) Ethernet Controller (3) I225-V
IRQ 4294967271~87	Intel(R) Ethernet Controller (3) I225-LM
IRQ 4294967288	Intel(R) Management Engine Interface #1
IRQ 4294967289	Intel(R) UHD Graphics 770
IRQ 4294967290	Intel(R) USB 3.20 eXtensible Host Controller - 1.20 (Microsoft)
IRQ 4294967291	Standard SATA AHCI Controller
IRQ 4294967292	Intel(R) PCI Express Root Port #5 - 7ABC
IRQ 4294967293	Intel(R) PCI Express Root Port #4 - 7ABB
IRQ 4294967294	Intel(R) PCI Express Root Port #3 - 7ABA

## C. Watchdog Timer Configuration

The Watchdog Timer (WDT) is used to generate a variety of output signals after a user programmable count. The WDT is suitable for use in the prevention of system lock-up, such as when software becomes trapped in a deadlock. Under these sorts of circumstances, the timer will count to zero and the selected outputs will be driven.

Under normal circumstance, you will need to restart the WDT at regular intervals before the timer counts to zero.

### Sample Code:

```
//-----
//
// THIS CODE AND INFORMATION IS PROVIDED "AS IS" WITHOUT WARRANTY OF ANY
// KIND, EITHER EXPRESSED OR IMPLIED, INCLUDING BUT NOT LIMITED TO THE
// IMPLIED WARRANTIES OF MERCHANTABILITY AND/OR FITNESS FOR A PARTICULAR
// PURPOSE.
//
//-----
#include <dos.h>
#include <conio.h>
#include <stdio.h>
#include <stdlib.h>
#include "F81966.H"
//-----
int main (int argc, char *argv[]);
void EnableWDT(int);
void DisableWDT(void);
//-----
int main (int argc, char *argv[])
{
    unsigned char bBuf;
    unsigned char bTime;
    char **endptr;

    char SIO;

    printf("Fintek 81966 watch dog program\n");
    SIO = Init_F81966();
    if (SIO == 0)
    {
        printf("Can not detect Fintek 81966, program abort.\n");
        return(1);
    }/if (SIO == 0)

    if (argc != 2)
    {
        printf("Parameter incorrect!!\n");
        return (1);
    }
}
```

```

bTime = strtol(argv[1], endptr, 10);
printf("System will reset after %d seconds\n", bTime);

if (bTime)
{
    EnableWDT(bTime);
}
else
{
    DisableWDT();
}
return 0;
}
//-----
void EnableWDT(int interval)
{
    unsigned char bBuf;

    bBuf = Get_F81966_Reg(0x2B);
    bBuf &= (~0x20);
    Set_F81966_Reg(0x2B, bBuf);           //Enable WDTO

    Set_F81966_LD(0x07);                 //switch to logic device 7
    Set_F81966_Reg(0x30, 0x01);         //enable timer

    bBuf = Get_F81966_Reg(0xF5);
    bBuf &= (~0x0F);
    bBuf |= 0x52;
    Set_F81966_Reg(0xF5, bBuf);         //count mode is second

    Set_F81966_Reg(0xF6, interval);     //set timer

    bBuf = Get_F81966_Reg(0xFA);
    bBuf |= 0x01;
    Set_F81966_Reg(0xFA, bBuf);         //enable WDTO output

    bBuf = Get_F81966_Reg(0xF5);
    bBuf |= 0x20;
    Set_F81966_Reg(0xF5, bBuf);         //start counting
}
//-----
void DisableWDT(void)
{
    unsigned char bBuf;

    Set_F81966_LD(0x07);                 //switch to logic device 7

    bBuf = Get_F81966_Reg(0xFA);
    bBuf &= ~0x01;
    Set_F81966_Reg(0xFA, bBuf);         //disable WDTO output

    bBuf = Get_F81966_Reg(0xF5);
    bBuf &= ~0x20;
    bBuf |= 0x40;
    Set_F81966_Reg(0xF5, bBuf);         //disable WDT
}
//-----

```

```
//-----  
//  
// THIS CODE AND INFORMATION IS PROVIDED "AS IS" WITHOUT WARRANTY OF ANY  
// KIND, EITHER EXPRESSED OR IMPLIED, INCLUDING BUT NOT LIMITED TO THE  
// IMPLIED WARRANTIES OF MERCHANTABILITY AND/OR FITNESS FOR A PARTICULAR  
// PURPOSE.  
//  
//-----  
#include "F81966.H"  
#include <dos.h>  
//-----  
unsigned int F81966_BASE;  
void Unlock_F81966 (void);  
void Lock_F81966 (void);  
//-----  
unsigned int Init_F81966(void)  
{  
    unsigned int result;  
    unsigned char ucDid;  
  
    F81966_BASE = 0x4E;  
    result = F81966_BASE;  
  
    ucDid = Get_F81966_Reg(0x20);  
    if (ucDid == 0x07)                //Fintek 81966  
    {      goto Init_Finish;          }  
  
    F81966_BASE = 0x2E;  
    result = F81966_BASE;  
  
    ucDid = Get_F81966_Reg(0x20);  
    if (ucDid == 0x07)                //Fintek 81966  
    {      goto Init_Finish;          }  
  
    F81966_BASE = 0x00;  
    result = F81966_BASE;  
  
Init_Finish:  
    return (result);  
}  
//-----  
void Unlock_F81966 (void)  
{  
    outportb(F81966_INDEX_PORT, F81966_UNLOCK);  
    outportb(F81966_INDEX_PORT, F81966_UNLOCK);  
}  
//-----  
void Lock_F81966 (void)  
{  
    outportb(F81966_INDEX_PORT, F81966_LOCK);  
}  
//-----  
void Set_F81966_LD( unsigned char LD)  
{  
    Unlock_F81966();  
    outportb(F81966_INDEX_PORT, F81966_REG_LD);  
    outportb(F81966_DATA_PORT, LD);  
}
```

```

        Lock_F81966();
    }
    //-----
void Set_F81966_Reg( unsigned char REG, unsigned char DATA)
{
    Unlock_F81966();
    outputb(F81966_INDEX_PORT, REG);
    outputb(F81966_DATA_PORT, DATA);
    Lock_F81966();
}
//-----
unsigned char Get_F81966_Reg(unsigned char REG)
{
    unsigned char Result;
    Unlock_F81966();
    outputb(F81966_INDEX_PORT, REG);
    Result = inportb(F81966_DATA_PORT);
    Lock_F81966();
    return Result;
}
//-----

//-----
//
// THIS CODE AND INFORMATION IS PROVIDED "AS IS" WITHOUT WARRANTY OF ANY
// KIND, EITHER EXPRESSED OR IMPLIED, INCLUDING BUT NOT LIMITED TO THE
// IMPLIED WARRANTIES OF MERCHANTABILITY AND/OR FITNESS FOR A PARTICULAR
// PURPOSE.
//
//-----
#ifndef F81966_H
#define F81966_H                1
//-----
#define F81966_INDEX_PORT      (F81966_BASE)
#define F81966_DATA_PORT      (F81966_BASE+1)
//-----
#define F81966_REG_LD          0x07
//-----
#define F81966_UNLOCK          0x87
#define F81966_LOCK            0xAA
//-----
unsigned int Init_F81966(void);
void Set_F81966_LD( unsigned char);
void Set_F81966_Reg( unsigned char,
unsigned char); unsigned char
Get_F81966_Reg( unsigned char);
//-----
#endif // F81966_H

```

## D. Onboard Connector Types

Function	Connector	Type	Compatible Mating Type (for reference)
DVI-D	J8	HK_DF11-20S-PA66H	
COM1 & COM2 RS-232/422/485	CN7	YIMTEX 40909AANSABR	D-SUB 9-pin
Front Panel Audio	J1	E-call 0126-01-2821009	Dupont 2.54 mm 2*5-pin
Digital I/O Connector	J5	E-call 0196-01-200-100	Dupont 2.0 mm 2*5-pin
COM3, COM4 RS-232	J2 (COM3) J3 (COM4)	HAO GUO DF11-10S-PA66H	HRS DF11-10DS-2C
PS/2 Keyboard & Mouse	J7	HAO GUO DF11-8S-PA66H	HRS DF11-8DS-2C
USB 2.0	J10	E-call 0126-01-2811009	Dupont 2.54 mm 2*5-pin
USB 3.1	J11	PINREX 52X-40-20GU52	USB 3.0 IDC 19-pin
Front Panel Settings	J20	E-call 0126-01-203-200	Dupont 2.54 mm 2*5-pin
S3 Status	J19	[E-CALL 0126-01-203-040	Dupont 2.54 mm 2*2-pin
ATX Power	J22	HAO GUO 01-0018-03	ATX 4.2 mm 2*12-pin
ATX 12V Power	ATX_12V_2X1	HAO GUO 01-0018-02	ATX 4.2 mm 2*4-pin
CPU Fan Power	CPU_FAN1	Techbest W2-031104132S1WT(A)-L	Molex 47054-1000
System Fan Power	SYS_FAN1, SYS_FAN2, SYS_FAN3	Techbest W2-031104132S1WT(A)-L	Molex 47054-1000



**E. MBB1000 USB Power Control Bit Mapping.**

Function	Connector	Software Mapping
M.2 –E Key	J12	bit_0
USB 3.1	CN5(A,B)	bit_1