



I-7012(D)

I-7012F(D)

1-ch AI Module

Features

- Current and Voltage Inputs
- High Resolution: 16-bit
- 50 Hz Event Counter for Digital Input
- High/Low Alarm for Digital Output
- I-7012F(D)
 - 100 Hz High Sampling Rate
- Built-in Dual Watchdog



Introduction

The I-7012 is an Analog Input module that is designed for both voltage and current input types. In addition, the module provides 1 Digital Input channel as a 50 Hz event counter and 2 Digital Output channels that can be used as a high/low alarm. The I-7012 also features 3000 VDC intra-module isolation. The I-7012F is an Analog Input module that is designed for both voltage and current input types. The sampling rate for the I-7012F is adjustable and can be switched between fast mode and normal mode depending on your requirements. In addition, the module provides 1 Digital Input channel as a 50 Hz event counter and 2 Digital Output channels that can be used as a high/low alarm. The I-7012F also features 3000 VDC intra-module isolation.

Specifications

Model	I-7012	I-7012F
	I-7012D	I-7012FD
CPU Module		
Watchdog Timer	Module, Communication (Programmable)	
Display		
Type	7012D/FD	5-Digit 7 Segment LED Display
Isolation		
Intra-module Isolation	3000 VDC	
EMS Protection		
EFT (IEC 61000-4-4)	±4 kV to Power Line	
ESD (IEC 61000-4-2)	±2 kV Contact for Each Terminal	
Surge (IEC 61000-4-5)	±0.5 kV for Power Line	
LED Indicators		
Status	1 x Power and Communication	
Analog Input		
Channels	1 Differential	
Type	Voltage, Current	
Range	±150 mV, ±500 mV, ±1 V, ±5 V, ±10 V, ±20 mA (requires optional external 125 Ω resistor)	
Resolution	16-bit	
Accuracy	±0.05%	Normal Mode: ±0.05% Fast Mode: ±0.25%
Sampling Rate	10 Hz	Normal Mode: 10 Hz Fast Mode: 100 Hz
Input Impedance	20 MΩ	
Common Voltage Protection	±100 VDC	
Overvoltage Protection	±120 VDC	
Digital Input/Counter		
Channels	1	
Type	Dry Contact	
Sink/Source (NPN/PNP)	Source	
ON Voltage Level	Close to GND	

Applications

- Building Automation
- Factory Automation
- Machine Automation
- Remote Maintenance
- Remote Diagnosis
- Testing Equipment

Model	I-7012/F	I-7012D/FD
OFF Voltage Level	Open	
Max. Counts	65535 (16-bit)	
Frequency	50 Hz	
Input Impedance	3 kΩ	
Overvoltage Protection	±30 VDC	
Digital Output		
Channels	2	
Type	Open Collector	
Sink/Source (NPN/PNP)	Sink	
Load Voltage	+3.5 ~ +30 VDC	
Load Current	30 mA/Channel	
Power on Value	Programmable	
Safe Value	Programmable	
COM Ports		
Ports	1 x RS-485	
Baud Rate	1200 ~ 115200 bps	
Data Format	(N, 8, 1)	
Protocol	DCON	
Power		
Reverse Polarity Protection	Yes	
Input Range	+10 ~ +30 VDC	
Consumption	1.3 W	1.9 W
Mechanical		
Dimensions (mm)	72 x 123 x 35 (W x L x H)	
Installation	DIN-Rail Mounting	
Environment		
Operating Temperature	-25 ~ +75 °C	
Storage Temperature	-40 ~ +85 °C	
Humidity	10 ~ 95% RH, Non-condensing	

Internal I/O Structure

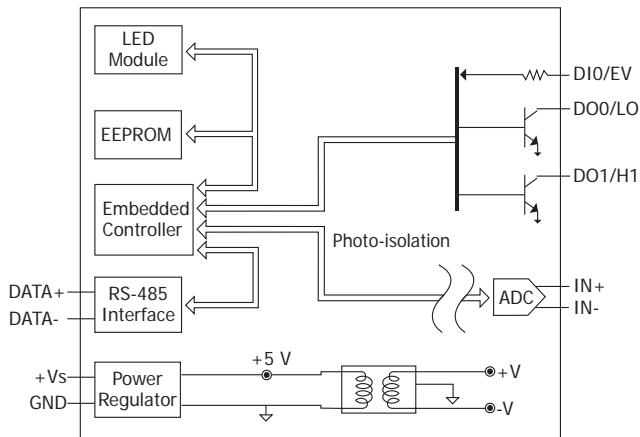

Pin Assignments

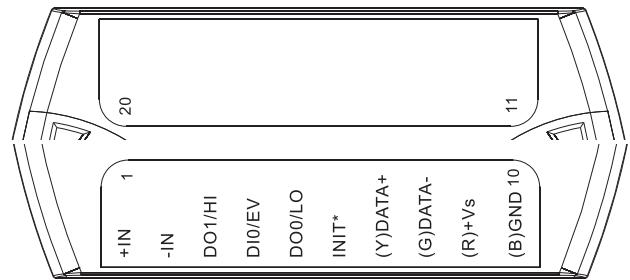







Wire Connections

Voltage Input		Current Input	
		<p>Requires an Optional External 125 Ω Resistor</p>	
Digital Input/Counter	Readback as 1	Readback as 0	
Dry Contact	Open	Closed to GND	
Digital Output	ON State Readback as 1	OFF State Readback as 0	
Resistance Load			
Inductance Load			

Ordering Information

I-7012 CR	1-ch AI Module using DCON Protocol (Blue Cover) (RoHS)
I-7012-G CR	1-ch AI Module using DCON Protocol (Gray Cover) (RoHS)
I-7012D CR	1-ch AI Module with LED Display using DCON Protocol (Blue Cover) (RoHS)
I-7012F CR	1-ch AI (Fast Sampling Version) Module using DCON Protocol (16-bit) (Blue Cover) (RoHS)
I-7012FD CR	1-ch AI (Fast Sampling Version) Module with LED Display using DCON Protocol (16-bit) (Blue Cover) (RoHS)

Accessories

tM-7520U CR	 Tiny Isolated RS-232 to RS-485 Converter (RoHS)	I-7514U-G CR	 Isolated 4-channel RS-485 Repeater/Hub/Splitter (Gray Cover) (RoHS)
tM-7561 CR	 Tiny USB to Isolated RS-485 Converter with CA-USB18 Cable (RoHS)	SG-770 CR	 7/14 channel Surge Protector (RoHS)
tM-SG4 CR	 RS-485 Pull-high/Pull-low and Termination Resistor Module (RoHS)	SG-3000 Series	 Signal Conditioning Modules for Thermocouple, RTD, DC Voltage, DC Current and Power Input Transformers