

LE-370

3.5 inch Motherboard

User's Manual

Edition 1.6
2022/07/28

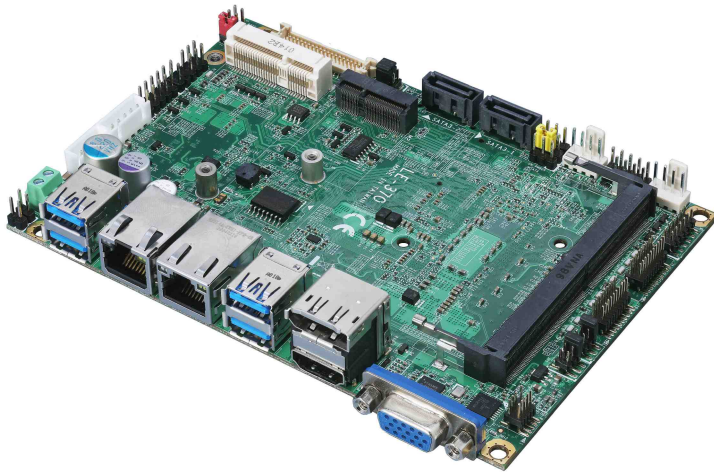

Copyright

Copyright 2022, all rights reserved. This document is copyrighted and all rights are reserved. The information in this document is subject to change without prior notice to make improvements to the products.

This document contains proprietary information and protected by copyright. No part of this document may be reproduced, copied, or translated in any form or any means without prior written permission of the manufacturer.

All trademarks and/or registered trademarks contains in this document are property of their respective owners.

Disclaimer

The company shall not be liable for any incidental or consequential damages resulting from the performance or use of this product.

The company does not issue a warranty of any kind, express or implied, including without limitation implied warranties of merchantability or fitness for a particular purpose.

The company has the right to revise the manual or include changes in the specifications of the product described within it at any time without notice and without obligation to notify any person of such revision or changes.

Trademark

All trademarks are the property of their respective holders.

Any questions please visit our website at <http://www.commell.com.tw>

Packing List:

Please check the package content before you starting using the board.



1 x LE-370 3.5 inch Miniboard

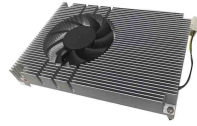

1 x Cooler Fan
(OHSF-370 / 2181010043)



1 xDC Input Power Cable
(OALDC-B / 1040513)



1 x SATA Power Cable
(OALSATA15-2PJ / 1040613)



2 x SATA Cable
(OALSATA3-L) / (1040529)

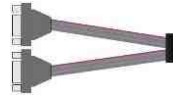

1 x Dual COM cable
(OALES-BKU2NB / 1040090)

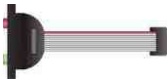

1 x Audio cable
(OALPJ-HDUNB / 1040123)



1 x PS/2 Keyboard & Mouse cable
(OALPS2/KM / 1040131) (Optional)

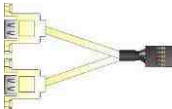

1 xUSB2.0 cable
(OALUSBA-3 / 1040173) (Optional)



1 x Driver CD
(Including User's Manual)

Index

Chapter 1 <Introduction>	4
1.1 <Product Overview>.....	4
1.2 <Product Specification>	5
1.3 <Block Diagram>.....	6
Chapter 2 <Hardware setup>	7
2.1 <Connector Location and Reference>	7
2.1.1 <Internal connectors list>	8
2.1.2 <External connectors list>	8
2.2 <Jumper Location and Reference>.....	9
2.2.1 <Jumper list>	9
2.2.2 <Clear CMOS and Power on type selection>	10
2.3 <Installing the Memory>	11
2.4 <I/O interface>.....	12
2.4.1 <Serial ATA interface>	12
2.4.2 <Ethernet interface>	12
2.4.3 <Display interface>	13
2.4.4 <Serial Port interface>.....	15
2.4.5 <USB interface>	17
2.4.6 <Audio interface>	18
2.4.7 <Expansion slot>	19
2.4.8 <Front panel switch and indicator>	20
2.4.9 <GPIO ,SMBus and Other Interface>.....	21
2.5 <Power supply>.....	24
2.5.1 <Power input>	24
2.5.2 <Power output>	24
Appendix A <Flash BIOS>	25
Appendix B <LCD Panel Type select>	26
Appendix C <Programmable Watch Dog Timer>	27
Appendix D <Hardware Monitor>	29
Appendix E <Programmable GPIO>	30
Appendix F <RAID Setting>	31
Appendix G <Installing Cooler fan>	32
Contact information	33

Chapter 1 <Introduction>

1.1 <Product Overview>

LE-370 is a 3.5" Motherboard which supports 11th Generation Intel® Core™ U-Series processors, integrated Intel® UHD Graphics, DDR4 memory, Realtek High Definition Audio, Intel Gigabit LAN, USB3.2 Gen2, SATA3 with AHCI function for a system.

New feature for Tiger Lake UP3

Tiger Lake UP3 processors are based on the 10nm process node, and offer long-life availability. They have a PCIe Gen4 for M.2 2280 slot.

All in One multimedia solution

The board provides MiniPCIe slot (support mSATA), M.2 2280 slot and M.2 2230 slot.

Tiger Lake support Windows10 version 2004 64bit and Linux kernel 5.8

Intel recommends using Windows 10 version 2004 64bit. It may lose some drivers if you use other Windows version.

Support OpenVINO for AI Computing

You can find more information at [Intel website](#)

1.2 <Product Specification>

System

Processor	Intel® Tiger Lake UP3 Processor, FCBGA1449 package
Memory	1 x DDR4 SO-DIMM 3200 MHz up to 32GB, Support Non-ECC, unbuffered memory
Watchdog Timer	Generates a system reset with internal timer for 1min/s ~ 255min/s
Real Time Clock	Chipset integrated RTC with onboard lithium battery
Expansion	1 x MiniPCIe (support mSATA), 1 x M.2 (Key E 2230) for Wi-Fi and Bluetooth 1 x M.2 (Key M 2280) Slot support PCIe Gen4

Graphics

Chipset	Intel® UHD Graphics
Display Interface	1 x LVDS (Note1) , 1 x DisplayPort (Note2), 1 x HDMI, 1 x VGA

LAN

Chip	1 x Intel® I225-LM Gigabit LAN 1 x Intel® I219-LM Gigabit PHY LAN (Support iAMT15.0)
------	---

I/O

Serial ATA	2 x SATA3 (CN_SATA3-1 cannot use when Mini_card change to mSATA)
Audio	Realtek ALC262 HD Audio
Digital I/O	Programmable 8-bit GPIO with 12 pin-header
Internal I/O	2 x SATA3, 2 x USB2.0, 2 x RS232, 2x RS232/485/422 1 x LVDS, 1 x LCD inverter connector, 1 x GPIO, 1 x Audio, 1 x PS/2, 1 x SMBus
Rear I/O	1 x DisplayPort(optional), 1 x VGA , 1 x HDMI, 4 x USB3.2 Gen2, 2 x LAN

Mechanical & Environmental

Power Requirement	DC input 9~35V
Size	146mm x 101mm (L x W)
Temperature	Operating within 0°C~60°C (32°F~140°F) Storage within -20°C~80°C (-4°F~176°F)
Relative Humidity	10%~90%, non-condensing

Note1: Onboard 18/24-bit single/dual channel +3.3V/ +5V/ +12V LVDS.

Note2: Add ADP-3355 supports 2nd VGA or Add ADP-3460 supports 2nd LVDS, please contact with our sales for OEM version.

1.3 <Block Diagram>

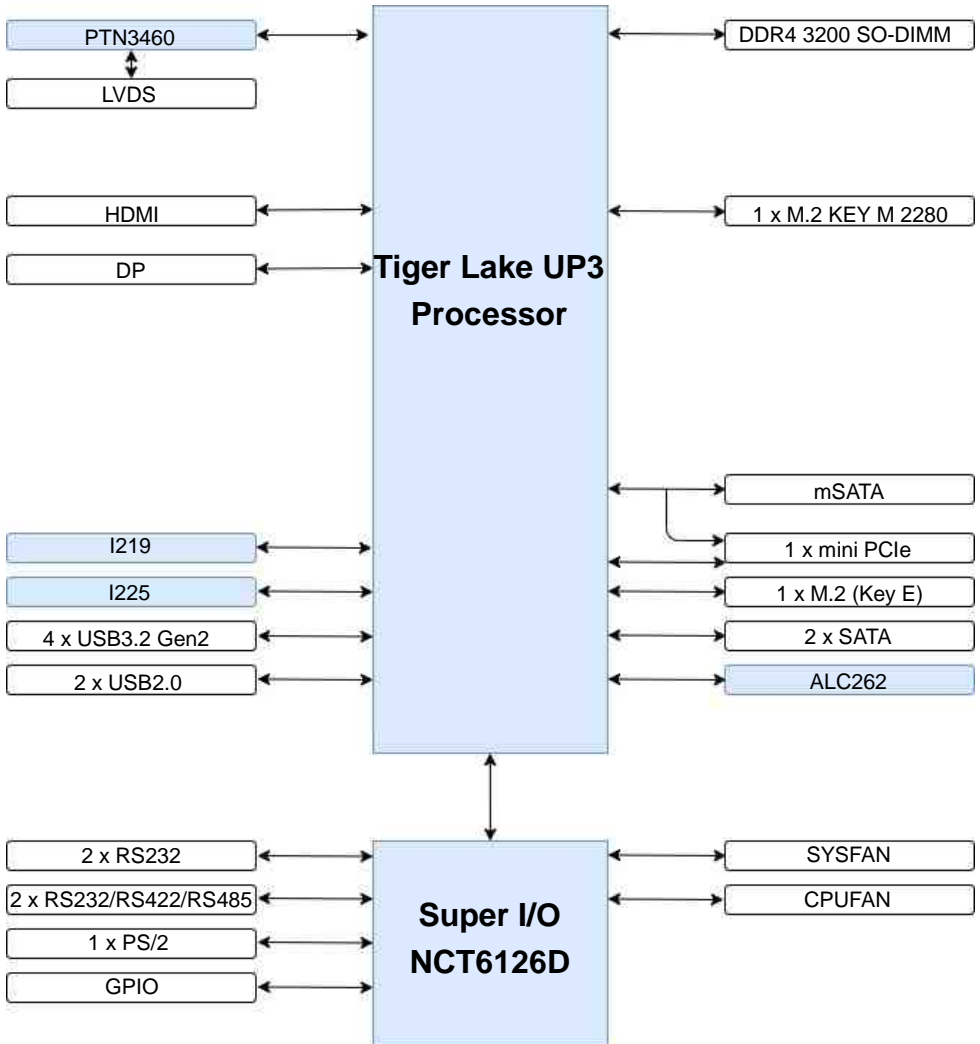

Chapter 2 <Hardware setup>

2.1 <Connector Location and Reference>

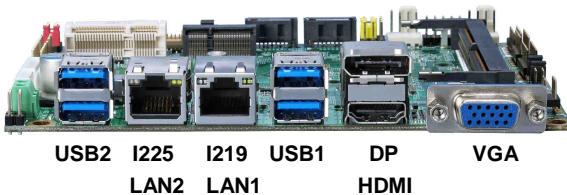
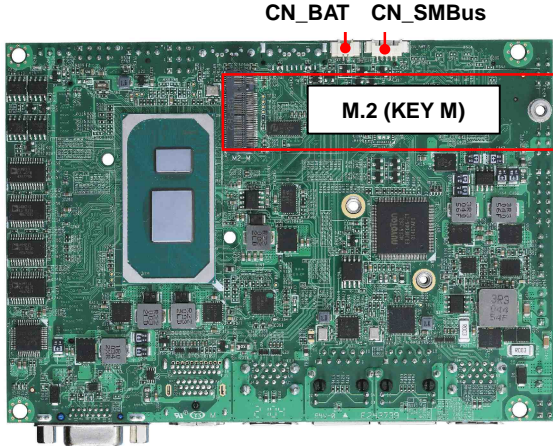
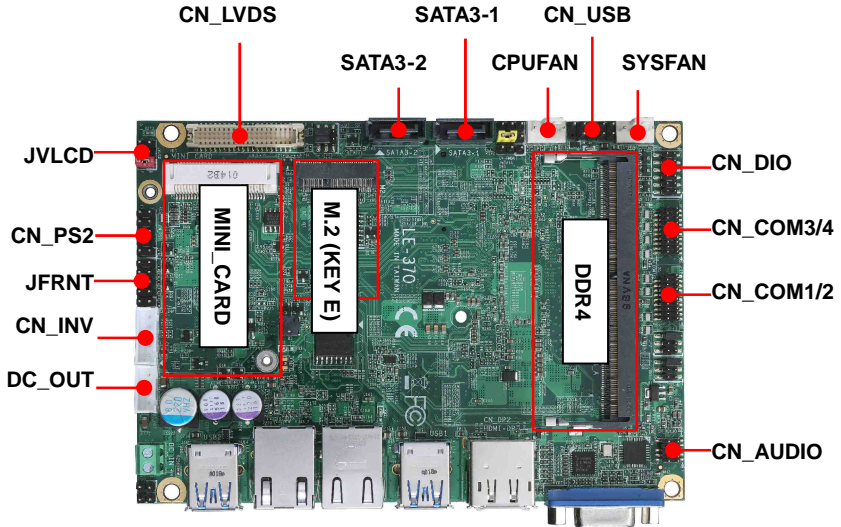

2.1.1 <Internal connectors list>

Connector	Function
DDR4	260-pin DDR4 SO-DIMM slot
SATA3-1/2	7-pin SATA3 connector
CN_AUDIO	5 x 2-pin audio pin header
CN_DIO	6 x 2-pin General Purpose In/Out pin header
CN_LVDS	20 x 2-pin LVDS connector
CN_INV	5-pin LCD inverter connector
CN_COM1/2	20-pin RS232 connector
CN_COM3/4	20-pin RS232/422/485 connector
CN_USB	5 x 2-pin USB 2.0 pin header
CN_PS2	5 x 2-pin PS/2 pin header
CN_SMBus	5-pin SMBus connector
CPUFAN	4-pin CPU fan connector
SYSFAN	4-pin System fan connector
JFRNT	5 x 2-pin front panel switch/indicator pin header
MINI_CARD	52-pin MiniPCIe card slot
M2	75-pin M.2 Key E slot
M2_M	75-pin M.2 Key M slot
DC_OUT	4-pin SATA Power connector
DC_IN	2-pin power input Terminal Block

2.1.2 <External connectors list>

Connector	Function
VGA	DB9 connector
HDMI-DP	DisplayPort and HDMI dual layer connector
USB1	2 x USB3.2 Gen2 connector
USB2	2 x USB3.2 Gen2 connector
LAN1	RJ45 connector (I219)
LAN2	RJ45 connector (I225)

2.2 <Jumper Location and Reference>

2.2.1 <Jumper list>

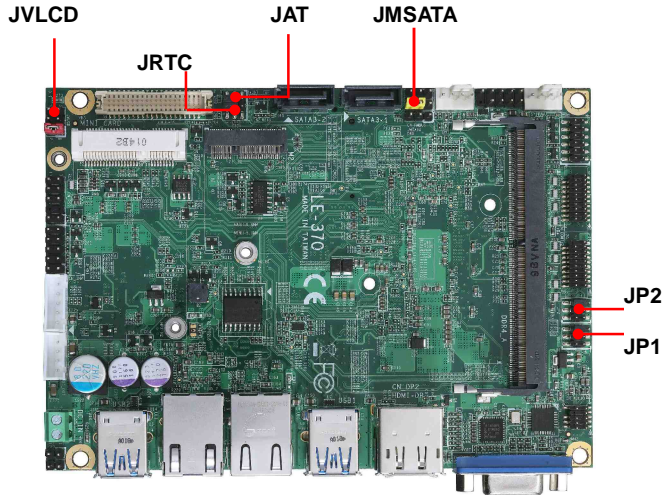

Jumper	Function
JAT	Power mode select
JRTC	CMOS Normal/Clear Setting
JVLCD	Panel Voltage Setting
JMSATA	MiniCard mSATA Setting
JP1/2	COM1 and CN_COM2 9-pin setting

2.2.2 <Clear CMOS and Power on type selection>

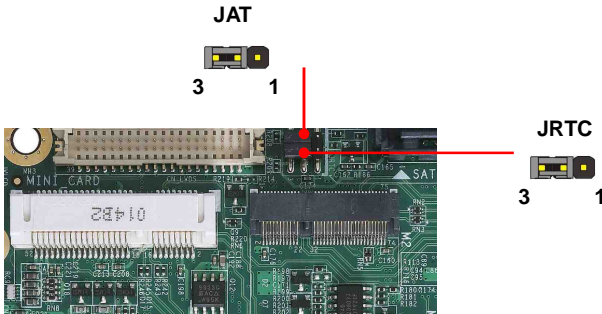

JRTC: Clear CMOS data jumper

Jumper settings	Function
1-2	Clear CMOS
2-3	Normal (Default)

JAT: AT/ATX mode select jumper

Jumper settings	Function
1-2	AT mode
2-3	ATX mode (Default)

2.3 <Installing the Memory>

LE-370 has 260-pin DDR4 SODIMM support up to 32GB of memory capacity and 1.2 Voltage. The memory frequency supports 3200 MHz. Only Non-ECC memory is supported.

In the process, the board must be powered off.

1. Put the memory tilt into the slot. Note the Memory notch key aligned slot key.
2. Then press down till lock into the mounting notch.

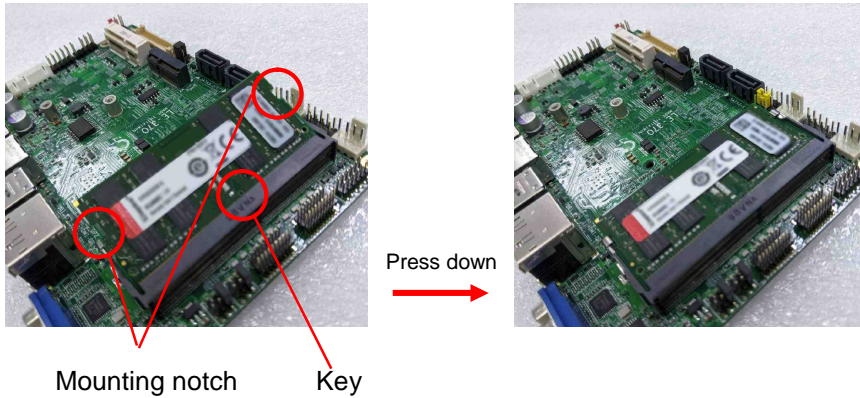

3. To remove the memory, push outward on both sides of the latch.

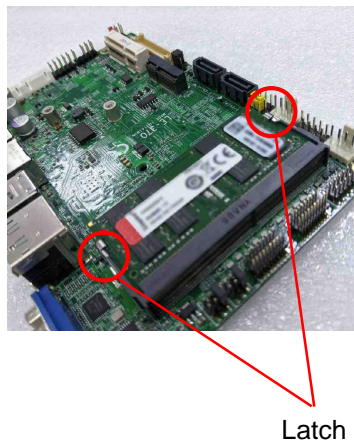

2.4 <I/O interface>

2.4.1 <Serial ATA interface>

Support RAID0, RAID1

SATA 1/2: SATA3 7-pin connector

Pin	Signal
1	GND
2	TX+
3	TX-
4	GND
5	RX-
6	RX+
7	GND

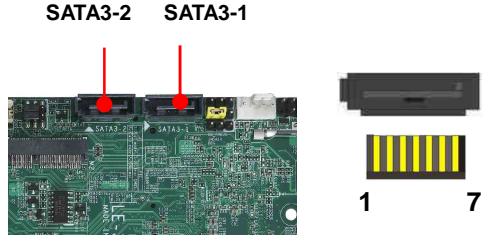

2.4.2 <Ethernet interface>

The board provides I219-LM and I225-LM Gigabit Ethernet which supports WOL on rear I/O. It supports Intel® AMT 15.0 feature on I219-LM.

(Note that the CPU must support vPro technology.)

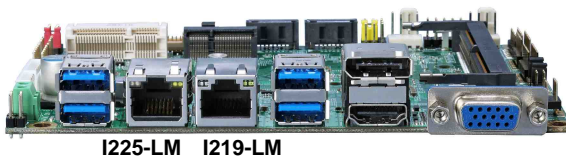

2.4.3 <Display interface>

Based on the 11th Gen CPU with built-in Intel® UHD Graphics, the DisplayPort resolution up to 3840x2160 @ 60Hz or 4096x2304 @ 60Hz, the HDMI up to 4096x2304 @ 24Hz and LVDS up to 1920x1200 @ 60Hz supports single bus or dual bus LVDS signaling with color depths of 18 bits or 24 bits. About select LCD Panel Type in BIOS, please refer [Appendix B](#). The built-in HD Graphics support Quad display function with clone mode and extended mode.

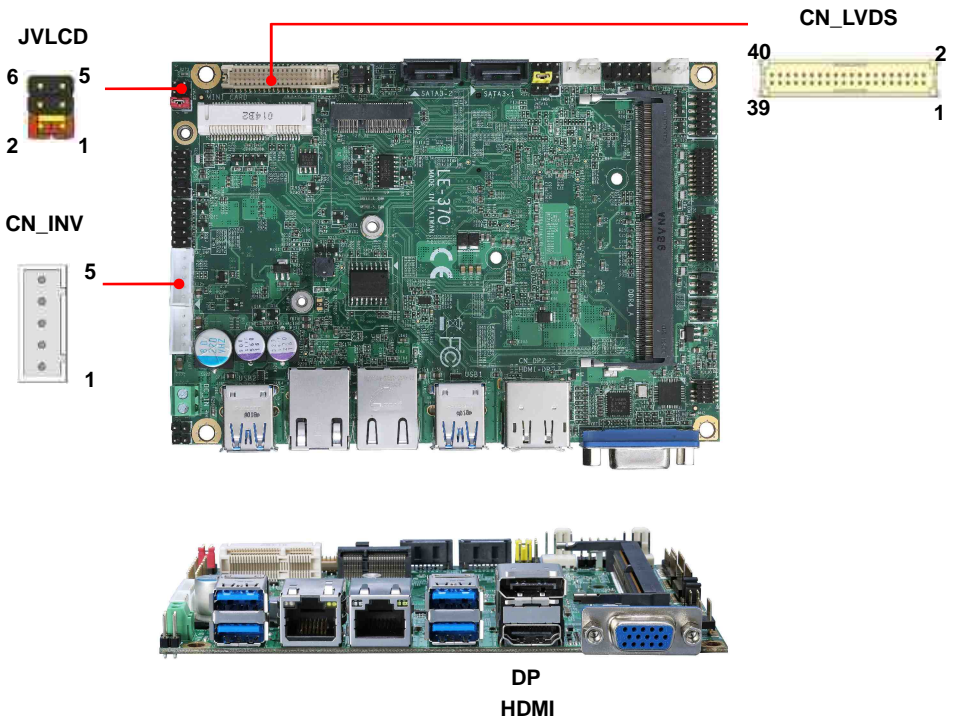

- Note: 1. The HDMI-DP dual layer connector can be changed HDMI & CN_DP, CN_DP function for use “ADP-3355” VGA module. (The VGA resolution is up to 2048x1536 @50Hz.)
2. ADP-3355 no need install extra driver. Here is Setup manual [Link](#).

CN_LVDS: LVDS 40-pin connector (Model: HIROSE DF13-40DP-1.25V compatible)

Pin	Signal	Pin	Signal
2	Set by JVLCD	1	Set by JVLCD
4	Detect (Active low)	3	GND
6	A_LVDS_0-	5	B_LVDS_0-
8	A_LVDS_0+	7	B_LVDS_0+
10	GND	9	GND
12	A_LVDS_1-	11	B_LVDS_1-
14	A_LVDS_1+	13	B_LVDS_1+
16	GND	15	GND
18	A_LVDS_2-	17	B_LVDS_2-
20	A_LVDS_2+	19	B_LVDS_2+
22	GND	21	GND
24	A_LVDS_CLK-	23	B_LVDS_3-
26	A_LVDS_CLK+	25	B_LVDS_3+
28	GND	27	GND
30	A_LVDS_3-	29	B_LVDS_CLK-
32	A_LVDS_3+	31	B_LVDS_CLK+
34	GND	33	GND
36	LVDS_DDCSCL	35	NC
38	LVDS_DDCSDA	37	NC
40	NC	39	NC

Note: Pin4 only need to be connected to GND

CN_INV: LVDS 5-pin Backlight power connector

Pin	Signal
1	12V
2	Backlight Control
3	GND
4	GND
5	Enable Backlight

JVLCD: LVDS panel power select jumper

Jumper settings	Function
1-2	3.3V (Default)
3-4	5V
5-6	12V

Effective patterns of connection: 1-2 / 3-4 / 5-6
Other may cause damage

2.4.4 <Serial Port interface>

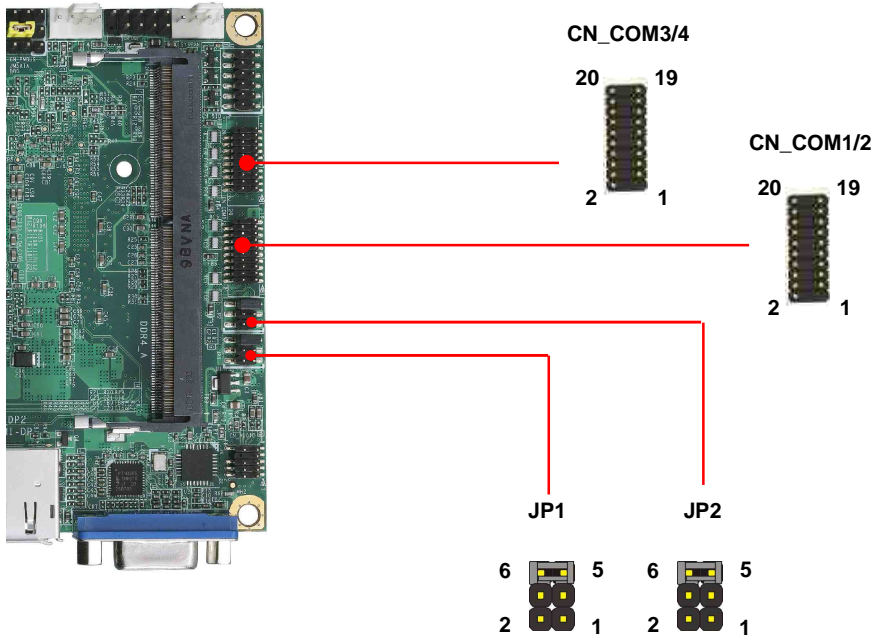

COM1/2: RS232 20-pin header (Pitch 2.54 x 1.27mm)

Pin	Signal	Pin	Signal
1	DCD1	2	RXD1
3	TXD1	4	DTR1
5	GND	6	DSR1
7	RTS1	8	CTS1
9	RI1	10	NC
11	DCD2	12	RXD2
13	TXD2	14	DTR2
15	GND	16	DSR2
17	RTS2	18	CTS2
19	RI2	20	Key

COM3/4: RS232/422/485 20-pin header (Pitch 2.54 x 1.27mm)

Pin	Signal	Pin	Signal
1	DCD1/ 422TX-/ 485-	2	RXD1/ 422TX+/ 485+
3	TXD1	4	DTR1
5	GND	6	DSR1/ 422RX+
7	RTS1	8	CTS1/ 422RX-
9	RI1	10	NC
11	DCD2/ 422TX-/ 485-	12	RXD2/ 422TX+/ 485+
13	TXD2	14	DTR2
15	GND	16	DSR2/ 422RX+
17	RTS2	18	CTS2/ 422RX-
19	RI2	20	Key

COM3 & COM4

RS-232/422/485 can set by BIOS.

You can find the setting from

Advanced-> Motherboard Advanced menu-> Super IO configuration-> Serial Port configuration->Interface

If you want to use RS485, please follow below step before connection. .

COM1 RTX- Data- : short Pin1& Pin8

COM1 RTX+ Data+ : short Pin2& Pin6

COM2 RTX- Data-: short Pin1& Pin8

COM2 RTX+ Data+: short Pin2& Pin6

JP1, JP2: COM1, COM2 pin-9 setting

Jumper settings	Function
1-2	5V
3-4	12V
5-6	RI (Default)

Effective patterns of connection:

1-2 / 3-4 / 5-6

Other may cause damage

2.4.5 <USB interface>



CN_USB

9 1



2

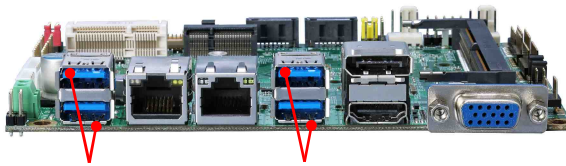

USB3.2 Gen2

USB3.2 Gen2

CN_USB: Front panel USB2.0 10-pin header (Pitch 2.54mm)

Pin	Signal	Pin	Signal
1	5VSB	2	5VSB
3	DATA0-	4	DATA1-
5	DATA0+	6	DATA1+
7	GND	8	GND
9	GND	10	Key

2.4.6 <Audio interface>

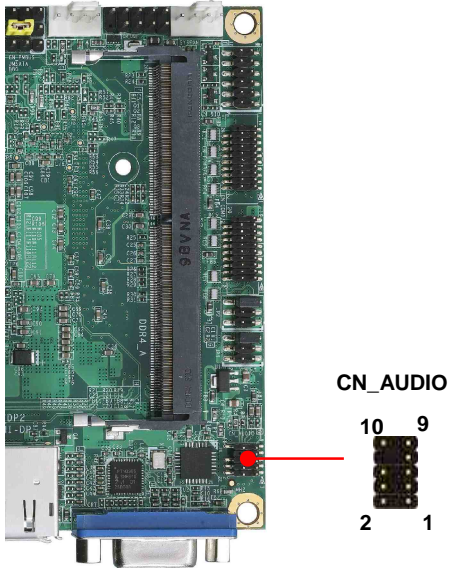

CN_AUDIO: Front panel audio 10-pin header (Pitch 1.27mm x 2.54mm)

Pin	Signal	Pin	Signal
1	MIC_L	2	GND
3	MIC_R	4	NC
5	FP_OUT_R	6	MIC_DETECT
7	SENSE	8	Key
9	FP_OUT_L	10	FP_OUT_DETECT

2.4.7 <Expansion slot>

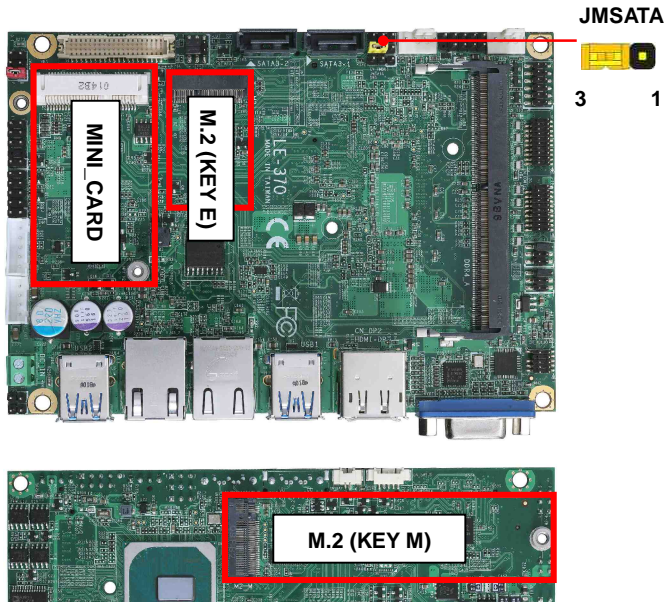

MINI_CARD has some special design to compatible our mini-PCIe card.

MINI_CARD supports mSATA by JMSATA

M2 (Key E) with 2x PCI Express x1 support WI-FI and Bluetooth Module

M2-M (Key M) with 4x PCIe Gen4, support NVMe SSD.

JMSATA: Setting MINI_CARD to support PCIe/mSATA

Jumper settings	Function
1-2	Support mSATA
2-3	Normal operation (Default)

CN_SATA3-1 cannot use when Mini_card change to mSATA

2.4.8 <Front panel switch and indicator>

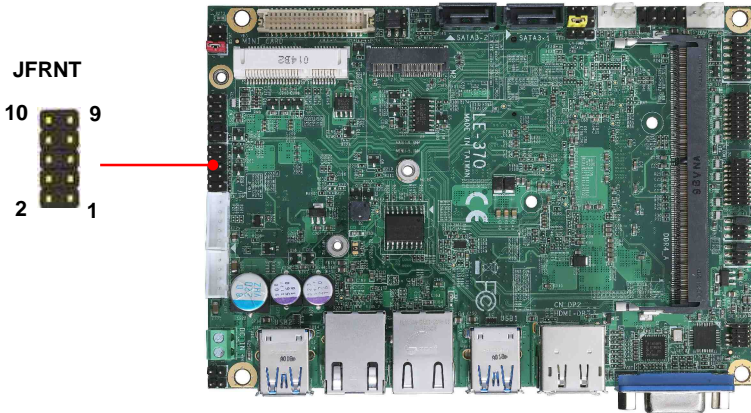

JFRNT: Front panel switch and indicator 10-pin header

Pin	Signal	Pin	Signal
1	Power_ON-	2	Power_ON+
3	Speaker-	4	Speaker+
5	HDD_LED-	6	HDD_LED+
7	Power_LED-	8	Power_LED+
9	Reset+	10	Reset-

2.4.9 <GPIO ,SMBus and Other Interface>

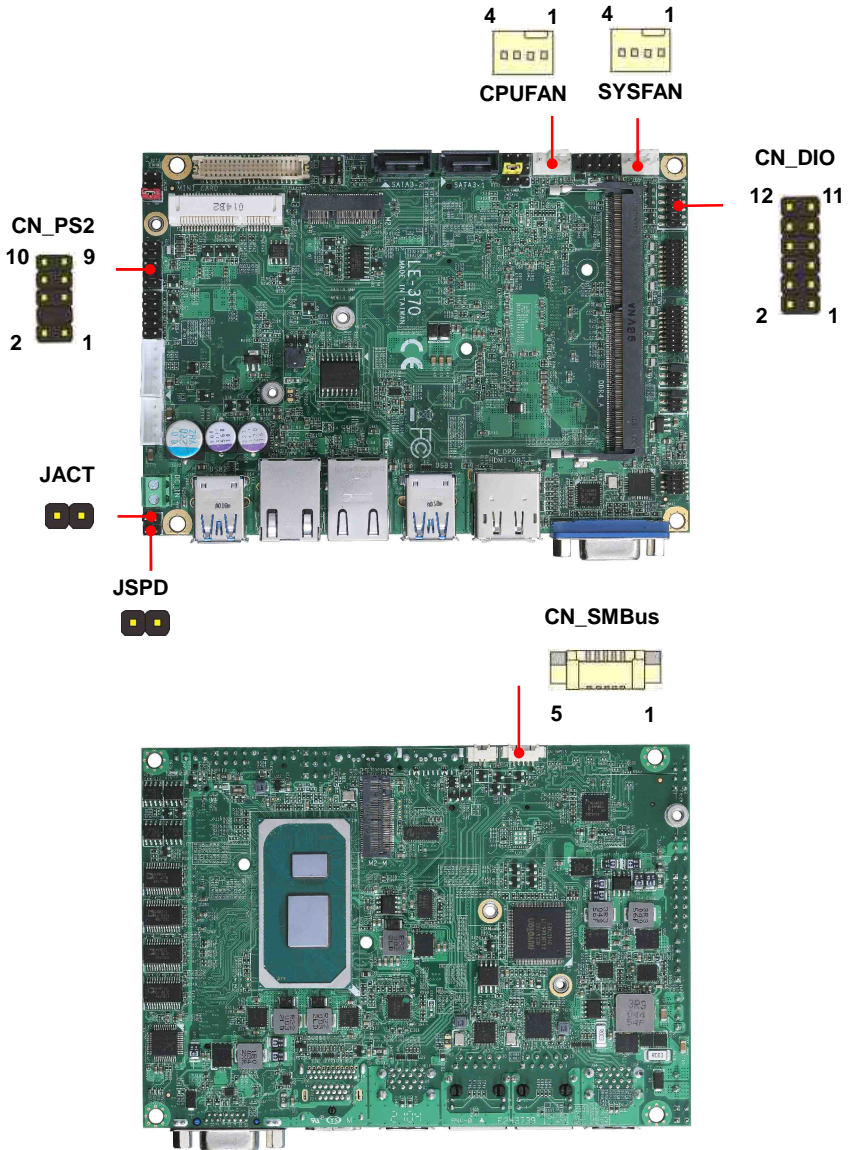

When using GPIO function, please note:

As Output: **Open-drain**, most applications need use an external pull up resistor.

(If not may cause damage)

As Input: **TTL-level**.

GPIO DC characteristics (open drain mode)

Parameter	SYM	MIN	TYP	MAX	UNIT	Conditions
Input Low Voltage	V_{IL}			0.8	V	
Input High Voltage	V_{IH}	2.0			V	
Output Low Voltage	V_{OL}			0.4	V	$I_{OL} = 12\text{mA}$
Input High Leakage	I_{LH}			+10	μA	$V_{IN} = 3.3\text{V}$
Input Low Leakage	I_{LL}			-10	μA	$V_{IN} = 0\text{V}$

Please refer to [Appendix E](#) to program the configuration register

CN_DIO: GPIO 12-pin header (Pitch 2.00mm)

Pin	Signal	Pin	Signal
1	GND	2	GND
3	GP40	4	GP44
5	GP41	6	GP45
7	GP42	8	GP46
9	GP43	10	GP47
11	5V	12	12V

CN_PS2: PS/2 10-pin header (Pitch 2.54mm)

Pin	Signal	Pin	Signal
1	KB_DATA	2	M_DATA
3	NC	4	NC
5	GND	6	GND
7	VCC	8	VCC
9	KB_CLK	10	M_CLK

CN_SMBus: SMBus 5-pin connector

Pin	Signal
1	5V
2	NC
3	SMBDAT
4	SMBCLK
5	GND

CPUFAN: CPU cooler fan 4-pin connector

Pin	1	2	3	4
Signal	GND	12V	Sensor	Control

SYSFAN: System cooler fan 4-pin connector

Pin	1	2	3	4
Signal	GND	12V	Sensor	Control

JACT: I219 RJ45 ACT LED 2-pin connector

Pin	Signal
1	I219 ACT LED-
2	I219 ACT LED+

JSPD: I219 RJ45 SPEED LED 2-pin connector

Pin	Signal
1	I219 SPEED LED+ (1G) / I219 SPEED LED- (10/100M)
2	I219 SPEED LED- (1G) / I219 SPEED LED+ (10/100M)

2.5 <Power supply>

2.5.1 <Power input>

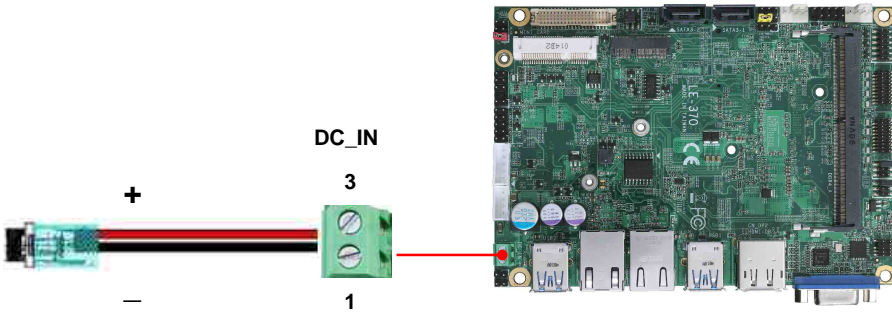

DC_IN: Terminal block 2-pin power connector

Pin	Signal	Pin	Signal
1	GND	2	9~35V Power input

2.5.2 <Power output>

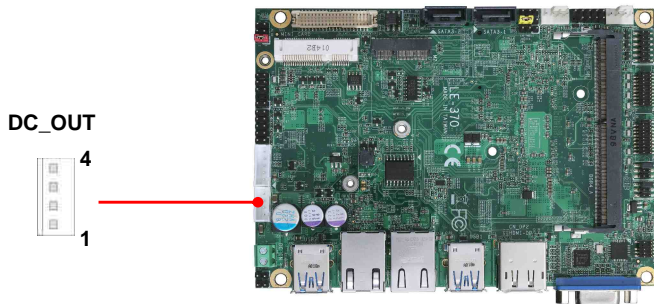

DC_OUT: SATA power 4-pin connector

Pin	Signal
1	12V
2	GND
3	GND
4	5V

Appendix A <Flash BIOS>

A.1 <Flash tool>

The board is based on Phoenix BIOS and can be updated easily by the BIOS auto flash tool. You can download the tool online at the address below:

[FPT Tool](#)

The tool's file name is "FPT.exe", it's the utility that can write the data into the BIOS flash chip and update the BIOS.

A.2 <Flash BIOS process>

- 1.Extract the zip file(re-flash tool and BIOS file) to root of the USB flash drive.
- 2.Insert your USB flash drive in USB port of the board and power on the system.
- 3.Press F5 in the Phoenix Logo screen
- 4.Click the Internal Shell, then input the "fs0:" command to switch to the root of the USB flash drive.
5. Type the " fpt -savemac -f xxx.bin" command to start flash BIOS processes. (xxx.bin means the BIOS file that you want to update)
6. When it finished all update processes, restart the system.

```

BIPT Interaction Shell v2.2
***
BIPT v2.70 (Phoenix Technologies Ltd., 0x12345670)
Mapping table
FS0: 011asG:HD0:65535a1:BLK2:
    P:Root(0x0)/P:1(0xL:0x0)/Sata(0x2,0xFFFF,0x0)/HD(1,GPT,955F6B01-1EE1-436E-9CF4-31CDB90E391F,0x000,0x10000)
BL0: 011asG:
    P:Root(0x0)/P:1(0xL:0x0)/Sata(0x1,0xFFFF,0x0)
BLK1: 011asG:
    P:Root(0x0)/P:1(0xL:0x0)/Sata(0x2,0xFFFF,0x0)
BLK0: 011asG:
    P:Root(0x0)/P:1(0xL:0x0)/Sata(0x2,0xFFFF,0x0)/HD(2,GPT,47E45D01-0006-4F3F-B00E-130E100C088B,0x100000,0x763F000)
Press ESC in 2 seconds to skip startup menu or any other key to continue.
Shell)
Shell)
Shell) fs0:
FS0-> fpt -savemac -f 071210_bin_
    
```

Appendix B <LCD Panel Type select>

According to your panel, it needs to select the correct resolution in the BIOS. If there is no fit for your panel type, please feedback for us to make an OEM model.

Find the setting from

Advanced->Motherboard Advanced menu->LVDS Configuration

EDID Panel type: There are 7 resolutions in LCD Panel Type, if your panel is not in the list, please contact tech@commell.com.tw

LVDS Bus: Select Single / Dual channel

Panel Color Depth: Select VESA 24 bit / JEIDA 24 bit / VESA and JEIDA 18 bit

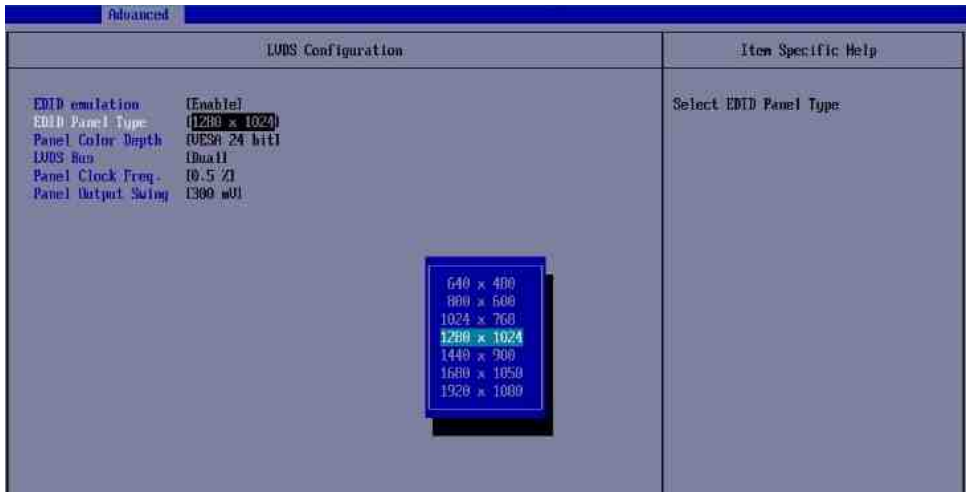

Appendix C <Programmable Watch Dog Timer>

The watchdog timer makes the system auto-reset while it stops to work for a period. The integrated watchdog timer can be setup as system reset mode by program. You can select Timer setting in the BIOS, after setting the time options, the system will reset according to the period of your selection.

Find the setting from

Advanced → Motherboard Advanced Menu → Power Advanced menu →

Watch dog timer select



Program sample

Watchdog timer setup as system reset with 5 second of timeout

```
-o 4E 87      ;enter configuration
-o 4E 87
-o 4E 07
-o 4F 08      ;select Logical Device
-o 4E 30
-o 4F 01      ; activate WDTO# function
-o 4E F0
-o 4F 00      ;set "00" is second mode, set "08" is minute mode
-o 4E F1
-o 4F 05      ;00h: Timeout Disable
                ;01h: Timeout occurs after 1 minute only
                ;02h: Timeout occurs after 2 second/minute
                ;03h: Timeout occurs after 3 second/minute
                ;
                ;FFh: Timeout occurs after 255 second/minute
                (The deviation is approx 1 second.)
```

For further information, please refer to Nuvoton NCT6126D datasheet

Appendix D <Hardware Monitor>

Find the setting from

Advanced-> Motherboard Advanced menu-> Super IO configuration->

└ Hardware Monitor

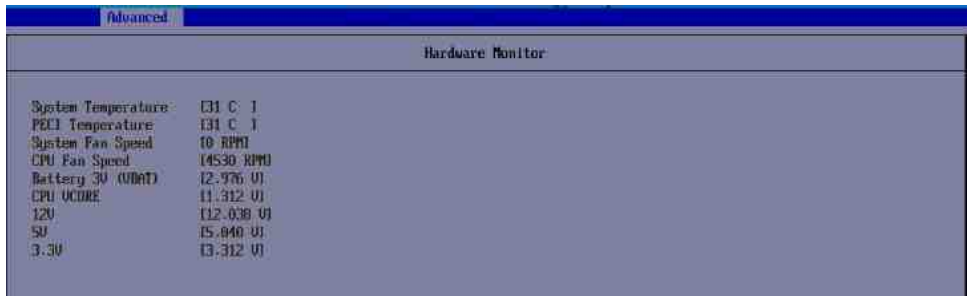

The screenshot shows a BIOS menu titled "Advanced" at the top. Below it, the "Hardware Monitor" section is displayed, listing various system metrics and their current values.

Hardware Monitor	
System Temperature	C31 C: 1
PECI Temperature	C31 C: 1
System Fan Speed	10 RPM
CPU Fan Speed	14530 RPM
Battery SV (VBAT)	12.976 V
CPU VCCORE	11.312 V
V20	112.038 V
V5	15.040 V
V3.30	13.312 V

Appendix E <Programmable GPIO>

The GPIO can be programmed with the MS-DOS debug program using simple IN/OUT commands.

GPIO	0	1	2	3	4	5	6	7
bit	0	1	2	3	4	5	6	7

- o 4E 87 ;enter configuration
- o 4E 87
- o 4E 07
- o 4F 07 ;select Logical Device
- o 4E 30
- o 4F 10 ;activate GPIO function (The board use GPIO4)
- o 4E F0
- o 4F XX ;set "01" GPIO as input, set "00" GPIO as output
- o 4E F1
- o 4F XX ;if set GPIO as output, this register's value can be set "00~ FF"

Optional

- o 4E F2
- o 4F XX ;set "01", the respective bit are inverted (Both input and output)
- ;set "00", the respective bit are normal

For further information, please refer to Nuvoton NCT6126D datasheet

Appendix F <RAID Setting>

When use RAID function, it need to enter the BIOS set RAID mode first.

Advanced \rightarrow Intel Advanced menu \rightarrow SA Configuration \rightarrow VMD Configuraion

1. Find VMD controller, and set to enable
2. Set "Map this Root port under VMD" to enable.
3. Set "Intel Optane memory to disabled
4. Press F10 to save.
5. In Misc page, you can find Intel® Rapid Storage Technology,
6. You can see "Create RAID Volume", then choose two disks to create.



Appendix G <Installing Cooler fan>

1. Tears the film on the Thermal Pad of Cooler Fan.
2. Install Cooler Fan on LE-370
3. Place two washers and tighten two screws.

(The suggestion screw torque of the Cooler Fan is 1.3KGf-cm)

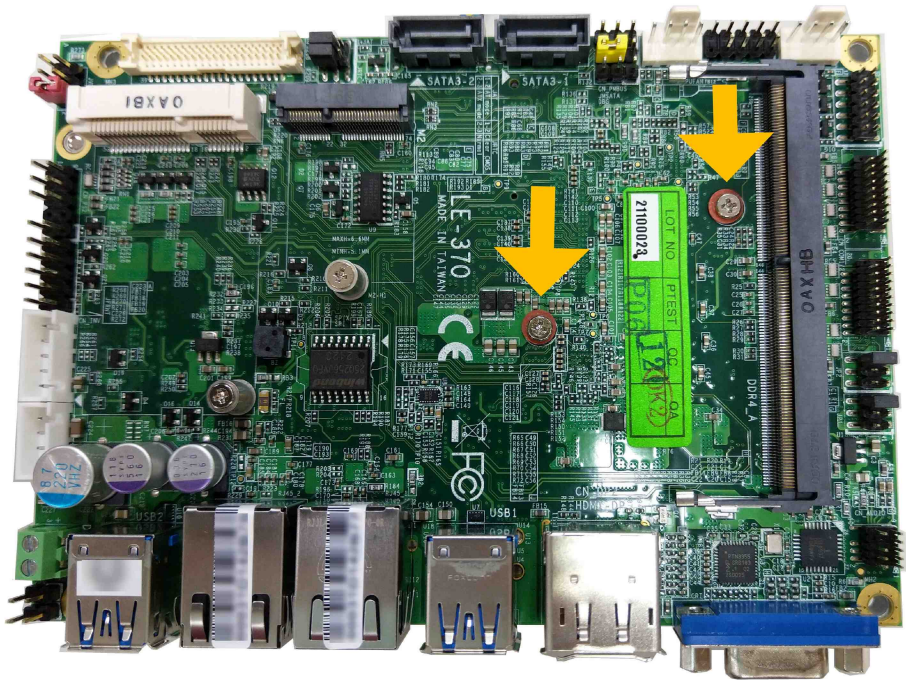

Contact information

Any advice or comment about our products and service, or anything we can help you please don't hesitate to contact with us. We will do our best to support you for your products, projects and business.

Taiwan Commate computer Inc.

Address	19F., NO.94, Sec. 1, Xintai 5 th Rd., Xizhi Dist., New Taipei City 22102, Taiwan.
TEL	+886-2-26963909
Website	www.commell.com.tw
E-mail	info@commell.com.tw (General information) tech@commell.com.tw (Technical Support)

Commell is a brand name of Taiwan Commate computer Inc.