



MODEL:

TANK-880-Q370 Series

Embedded System with 8th/9th Generation Intel® Core™ Processor,
8GB DDR4 Pre-installed Memory, Digital I/O, HDMI+DP, iDP,
Three Gigabit Ethernet, RS-232/422/485,
RoHS Compliant

User Manual

Revision

Date	Version	Changes
September 28, 2020	1.01	Updated the P/N of the optional power cord
June 11, 2020	1.00	Initial release

Copyright

COPYRIGHT NOTICE

The information in this document is subject to change without prior notice in order to improve reliability, design and function and does not represent a commitment on the part of the manufacturer.

In no event will the manufacturer be liable for direct, indirect, special, incidental, or consequential damages arising out of the use or inability to use the product or documentation, even if advised of the possibility of such damages.

This document contains proprietary information protected by copyright. All rights are reserved. No part of this manual may be reproduced by any mechanical, electronic, or other means in any form without prior written permission of the manufacturer.

TRADEMARKS

All registered trademarks and product names mentioned herein are used for identification purposes only and may be trademarks and/or registered trademarks of their respective owners.

Manual Conventions



WARNING

Warnings appear where overlooked details may cause damage to the equipment or result in personal injury. Warnings should be taken seriously.



CAUTION

Cautionary messages should be heeded to help reduce the chance of losing data or damaging the product.



NOTE

These messages inform the reader of essential but non-critical information. These messages should be read carefully as any directions or instructions contained therein can help avoid making mistakes.



HOT SURFACE

This symbol indicates a hot surface that should not be touched without taking care.

Table of Contents

1 INTRODUCTION.....	1
1.1 OVERVIEW.....	2
1.2 MODEL VARIATIONS	3
1.3 FEATURES.....	3
1.4 TECHNICAL SPECIFICATIONS	4
1.5 FRONT PANEL.....	6
1.6 REAR PANEL.....	7
1.7 PHYSICAL DIMENSIONS	8
2 UNPACKING	9
2.1 ANTI-STATIC PRECAUTIONS	10
2.2 UNPACKING PRECAUTIONS.....	10
2.3 UNPACKING CHECKLIST	11
3 INSTALLATION	13
3.1 INSTALLATION PRECAUTIONS	14
3.2 HARD DISK DRIVE (HDD) INSTALLATION.....	15
3.3 SYSTEM FAN INSTALLATION.....	16
3.4 MOUNTING THE SYSTEM WITH MOUNTING BRACKETS	17
3.5 EXTERNAL PERIPHERAL INTERFACE CONNECTORS.....	18
3.5.1 AT/ATX Power Mode Selection.....	19
3.5.2 Audio Connector	19
3.5.3 Digital Input / Output Connector.....	20
3.5.4 HDMI/DP Connector.....	20
3.5.5 LAN Connectors.....	21
3.5.6 Power Input, 4-pin Terminal Block.....	22
3.5.7 Power Input, 4-pin DIN Connector	22
3.5.8 DB-9 RS-232/422/485 Serial Port Connectors.....	23
3.6 INTERNAL PERIPHERAL INTERFACE CONNECTORS	23
3.6.1 iDP Module Installation.....	23

3.7 POWERING ON/OFF THE SYSTEM	28
3.8 POWER	28
3.9 AVAILABLE DRIVERS	30
3.10 DRIVER DOWNLOAD	30
4 SYSTEM MOTHERBOARD	32
4.1 OVERVIEW.....	33
4.1.1 Layout	33
4.2 INTERNAL PERIPHERAL CONNECTORS	34
4.2.1 Clear CMOS Switch (J_CMOS1).....	36
4.2.2 AT/ATX Mode Switch (J_AT_ATX1)	36
4.2.3 BIOS Programming Connector (JSPII)	36
4.2.4 RS-232 Pin Header (COM4).....	36
4.2.5 RS-232 Pin Header (COM5).....	37
4.2.6 Dual USB 2.0 Pin Header (USB1).....	37
4.2.7 TPM Pin Header (TPM1)	37
4.2.8 Power Button Pin Header (PWR_BTN1).....	38
4.2.9 BIOS Programmer Connector (J_SPII)	38
4.2.10 EC Programmer Connector (J_EC1)	38
4.2.11 EC Debug Card Connector (EC_DBG1).....	39
4.2.12 System Fan Connectors (SYS_FAN1/SYS_FAN2)	39
4.2.13 PCIe Power Input Connector (PCIE12V1).....	39
4.2.14 iDP Connector (IDP1).....	40
4.2.15 LAN LED Connector (LED_LAN1/LED_LAN2/LED_LAN3)	40
4.2.16 USB DOM Connector (SBM3: USB_DOM1).....	40
4.2.17 Battery Connector.....	41
4.3 EXTERNAL INTERFACE PANEL CONNECTORS	41
4.3.1 LAN Connectors.....	41
4.3.2 Power Input Connector, DC Jack (PWR1)	42
4.3.3 Power Input Connector, Terminal Block (PWR2).....	42
5 BIOS	43
5.1 INTRODUCTION.....	44
5.1.1 Starting Setup.....	44
5.1.2 Using Setup	44

TANK-880-Q370

5.1.3 Getting Help.....	45
5.1.4 Unable to Reboot after Configuration Changes	45
5.1.5 BIOS Menu Bar.....	45
5.2 MAIN.....	47
5.3 ADVANCED.....	49
5.3.1 CPU Configuration.....	50
5.3.2 PCH-FW Configuration.....	53
5.3.3 Trusted Computing.....	54
5.3.4 ACPI Settings.....	55
5.3.5 RTC Wake Settings.....	56
5.3.6 F81866 Super IO Configuration.....	57
5.3.6.1 Serial Port n Configuration.....	57
5.3.6.1.1 Serial Port 1 Configuration	58
5.3.6.1.2 Serial Port 2 Configuration	58
5.3.6.1.3 Serial Port 3 Configuration	59
5.3.6.1.4 Serial Port 4 Configuration	59
5.3.6.1.5 Serial Port 5 Configuration	60
5.3.7 iWDD H/W Monitor.....	60
5.3.8 Serial Port Console Redirection	63
5.3.9 USB Configuration.....	65
5.3.10 NVMe Configuration.....	66
5.3.11 iEi Feature.....	67
5.4 CHIPSET	68
5.4.1 System Agent (SA) Configuration	69
5.4.1.1 Memory Configuration	69
5.4.1.2 Graphics Configuration.....	70
5.4.1.3 PEG Port Configuration.....	72
5.4.2 PCH-IO Configuration	73
5.4.2.1 PCI Express Configuration	74
5.4.2.2 SATA Configuration.....	76
5.4.2.3 HD Audio Configuration.....	77
5.5 SECURITY.....	78
5.6 BOOT.....	79
5.7 SAVE & EXIT	81
5.8 SERVER MGMT	82

5.8.1.1 System Event Log.....	83
5.8.1.2 BMC network configuration.....	84
A REGULATORY COMPLIANCE	85
B BIOS OPTIONS	90
C TERMINOLOGY	93
D SAFETY PRECAUTIONS.....	97
D.1 SAFETY PRECAUTIONS	98
<i>D.1.1 General Safety Precautions.....</i>	<i>98</i>
<i>D.1.2 Anti-static Precautions.....</i>	<i>99</i>
<i>D.1.3 Product Disposal.....</i>	<i>100</i>
D.2 MAINTENANCE AND CLEANING PRECAUTIONS.....	100
<i>D.2.1 Maintenance and Cleaning.....</i>	<i>101</i>
<i>D.2.2 Cleaning Tools.....</i>	<i>101</i>
E DIGITAL I/O INTERFACE	103
E.1 INTRODUCTION	104
E.2 ASSEMBLY LANGUAGE SAMPLE 1	105
E.3 ASSEMBLY LANGUAGE SAMPLE 2	105
F ERROR BEEP CODE	106
F.1 PEI BEEP CODES	107
F.2 DXE BEEP CODES	107
G HAZARDOUS MATERIALS DISCLOSURE	108
G.1 RoHS II DIRECTIVE (2015/863/EU).....	109
G.2 CHINA RoHS	110

List of Figures

Figure 1-1: TANK-880-Q370 Series.....	2
Figure 1-2: Front Panel	6
Figure 1-3: Rear Panel.....	7
Figure 1-4: Physical Dimensions	8
Figure 3-1: Unscrew the Cover	15
Figure 3-2: HDD Bracket.....	15
Figure 3-3: HDD Installation	16
Figure 3-4: Fan Bracket.....	16
Figure 3-5: System Fan Installation	17
Figure 3-6: Mounting Bracket Retention Screws	18
Figure 3-7: AT/ATX Power Mode Switch	19
Figure 3-8: Audio Connector	19
Figure 3-9: DIO Connector	20
Figure 3-10: HDMI/DP Connection	20
Figure 3-11: LAN Connection	21
Figure 3-12: RJ-45 Ethernet Connector.....	21
Figure 3-13: 4-pin Terminal Block.....	22
Figure 3-14: Power Input Connector.....	22
Figure 3-15: DB-9 RS-232/422/485 Serial Port Connector	23
Figure 3-16: iDP Module with Bracket	24
Figure 3-17: Internal DisplayPort Connector Location	24
Figure 3-18: iDP Module with Bracket	25
Figure 3-19: iDP Module Installation.....	25
Figure 3-20: Remove Expansion Slot Bracket.....	26
Figure 3-21: Power Button.....	28
Figure 3-22: Power Connectors	29
Figure 3-23: IEI Resource Download Center.....	30
Figure 4-1: System Motherboard (Front).....	33
Figure 4-2: System Motherboard (Rear)	34
Figure 4-3: Ethernet Connector.....	42

List of Tables

Table 1-1: TANK-880-Q370 Series Model Variations	3
Table 1-2: Technical Specifications.....	5
Table 3-1: Digital I/O Connector Pinouts	20
Table 3-2: RJ-45 Ethernet Connector LEDs	22
Table 3-3: RS-232/422/485 Connector (COM1~COM3)	23
Table 3-4: iDP Converter Cards.....	27
Table 3-5: Power LED Indicators Description	29
Table 4-1: Peripheral Interface Connectors	35
Table 4-2: Clear CMOS Switch (J_CMOS1)	36
Table 4-3: AT/ATX Mode Switch (J_AT_ATX1).....	36
Table 4-4: BIOS Programming Connector Pinouts (JSPI1)	36
Table 4-5: RS-232 Pin Header (COM4)	36
Table 4-6: RS-232 Pin Header (COM5).....	37
Table 4-7: Dual USB 2.0 Pin Header (USB1).....	37
Table 4-8: TPM Pin Header (TPM1).....	38
Table 4-9: Power Button Pin Header (PWR_BTN1).....	38
Table 4-10: BIOS Programmer Connector (J_SPI1).....	38
Table 4-11: EC Programmer Connector (J_EC1)	38
Table 4-12: EC Debug Card Connector (EC_DBG1)	39
Table 4-13: System Fan Connectors (SYS_FAN1/SYS_FAN2).....	39
Table 4-14: PCIe Power Input Connector (PCIE12V1)	39
Table 4-15: iDP Connector (IDP1).....	40
Table 4-16: LAN LED Connector.....	40
Table 4-17: USB DOM Connector (SBM3: USB_DOM1)	40
Table 4-18: Battery Connector (BAT1).....	41
Table 4-19: Rear Panel Connectors.....	41
Table 4-20: Ethernet Connector Pinouts.....	41
Table 4-21: Connector LEDs.....	42
Table 4-22: Power Input Connector (PWR1).....	42
Table 4-23: Power Input Connector (PWR2).....	42

TANK-880-Q370

Table 5-1: BIOS Navigation Keys45

BIOS Menus

BIOS Menu 1: Main	47
BIOS Menu 2: Advanced	49
BIOS Menu 3: CPU Configuration	50
BIOS Menu 4: PCH-FW Configuration	53
BIOS Menu 5: Trusted Computing	54
BIOS Menu 6: AMT Configuration	55
BIOS Menu 7: F81866 Super IO Configuration	56
BIOS Menu 8: Serial Port n Configuration Menu	57
BIOS Menu 9: Serial Port n Configuration Menu	57
BIOS Menu 10: F81866 H/W Monitor	61
BIOS Menu 11: Smart Fan Mode Configuration	62
BIOS Menu 12: Serial Port Console Redirection	64
BIOS Menu 13: USB Configuration	65
BIOS Menu 14: NVMe Configuration	66
BIOS Menu 15: iEi Feature	67
BIOS Menu 16: Chipset	68
BIOS Menu 17: System Agent (SA) Configuration	69
BIOS Menu 18: Memory Configuration	69
BIOS Menu 19: Graphics Configuration	70
BIOS Menu 20: NB PCIe Configuration	72
BIOS Menu 21: PCH-IO Configuration	73
BIOS Menu 22: PCI Express Configuration	74
BIOS Menu 23: SATA Configuration	76
BIOS Menu 24: HD Audio Configuration	77
BIOS Menu 25: Security	78
BIOS Menu 26: Boot	79
BIOS Menu 27: Exit	81
BIOS Menu 28: Server Mgmt	82
BIOS Menu 29: System Event Log	83
BIOS Menu 30: PCH Azalia Configuration Menu	84

Chapter

1

Introduction

1.1 Overview



Figure 1-1: TANK-880-Q370 Series

The TANK-880-Q370 Series is an embedded system for wide range temperature environments. It is powered by the 8th/9th generation Intel® Core™ processor, uses the Intel® Q370 chipset and supports two 260-pin DDR4 SDRAM SO-DIMM modules up to 64GB (8GB memory preinstalled). The TANK-880-Q370 Series includes one digital I/O port, one HDMI, one DP, one iDP port (optional) , three GbE LAN ports, six USB 3.2 Gen 1 ports, and three RS-232/422/485 connectors.

TANK-880-Q370

1.2 Model Variations

The model variations of the TANK-880-Q370 Series are listed below.

Model No.	CPU
TANK-880-Q370-i7R/8G/4A	Intel® Core™ i7-9700TE 1.8 GHz (up to 3.8 GHz, 8-core, TDP 35W)
TANK-880-Q370-i5R/8G/4A	Intel® Core™ i5-9500TE 2.2 GHz (up to 3.6 GHz, 6-core, TDP 35W)

Table 1-1: TANK-880-Q370 Series Model Variations

1.3 Features

The TANK-880-Q370 Series features are listed below:

- 8th/9th Gen. Intel® Core™ processor platform with Intel® Q370 chipset and DDR4 memory
- Dual independent displays with high resolution support
- Rich high-speed I/O interfaces
- On-board internal power connector for providing power to add-on cards
- Four accessible 2.5" HDD/SSD SATA 6Gb/s bay (with RAID 0/1/5/10 support)
- Great flexibility for hardware expansion

1.4 Technical Specifications

The TANK-880-Q370 Series technical specifications are listed in Table 1-2

Specifications	
Chassis	
Color	Black C + Silver
Dimensions (WxDxH) (mm)	169 x 255.2 x 225 mm
System Fan	Fanless
Chassis Construction	Extruded aluminum alloy
Motherboard	
CPU	8th Gen. Intel® Core™ CPU & Intel® Core™ i7-9700TE 1.8GHz (up to 3.8GHz, 8-core, TDP 35W) Intel® Core™ i5-9500TE 2.2GHz (up to 3.6GHz, 6-core, TDP 35W)
Chipset	Intel® Q370
System Memory	2 x SO-DIMM DDR4 2666/2400MHz (8GB pre-installed, up to 64GB)
Storage	
Hard Drive	4 x 2.5" HDD/SSD SATA 6Gb/s bay (with RAID 0/1/5/10 support)
I/O Interfaces	
USB 3.2 Gen 1 (5Gb/s)	6
RS-232/422/485	3 x DB-9 with 2.5kV isolation
Ethernet	Three RJ-45 1 x PCIe GbE by Intel® I219 controller 2 x PCIe GbE by Intel® I210 controller
TPM 2.0	1 x TPM pin header (2x10 pin)
Digital I/O	8-bit (4-in/4-out)
Audio	1 x Line-out 1 x Mic-in

TANK-880-Q370

Specifications	
I/O Interfaces	
Display	HDMI/DP
Expansions	
PCIe Mini	1 x Full-size (PCIe x1 / USB 2.0 / SATA)
M.2	1 x 2230 A key (PCIe x2 / USB 2.0) 2 x 2280 M key (PCIe x2)
Backplane	1 x PCIe x16 1 x PCIe x1 2 x PCIe x4
Power	
Power Input	DC jack: 9 V~36 V DC Terminal block: 9 V~36 V DC
Power Consumption	19V @ 3.6A (Intel® Core™ i7-8700T with 8GB memory)
Internal Power Output	12V @ up to 10A
Reliability	
Mounting	Wall mount
Operating Temperature	-20°C ~ 60°C with air flow (SSD), 10% ~ 95%, non-condensing
Storage Temperature	-40°C~+85°C with air flow (SSD), 10% ~ 90%, non-condensing
Operating Shock	Half-sine wave shock 5G, 11ms, 100 shocks per axis
Operating Vibration	MIL-STD-810G 514.6C-1 (with SSD)
Weight (Net/Gross)	5.4 kg / 8.45 kg
Safety/EMC	CE/FCC
Watchdog timer	Programmable 1~255 sec/min
OS	
Supported OS	Microsoft® Windows® 10 IoT Enterprise Linux

Table 1-2: Technical Specifications

1.5 Front Panel

The front panel of the TANK-880-Q370 Series has the following features (Figure 1-2):

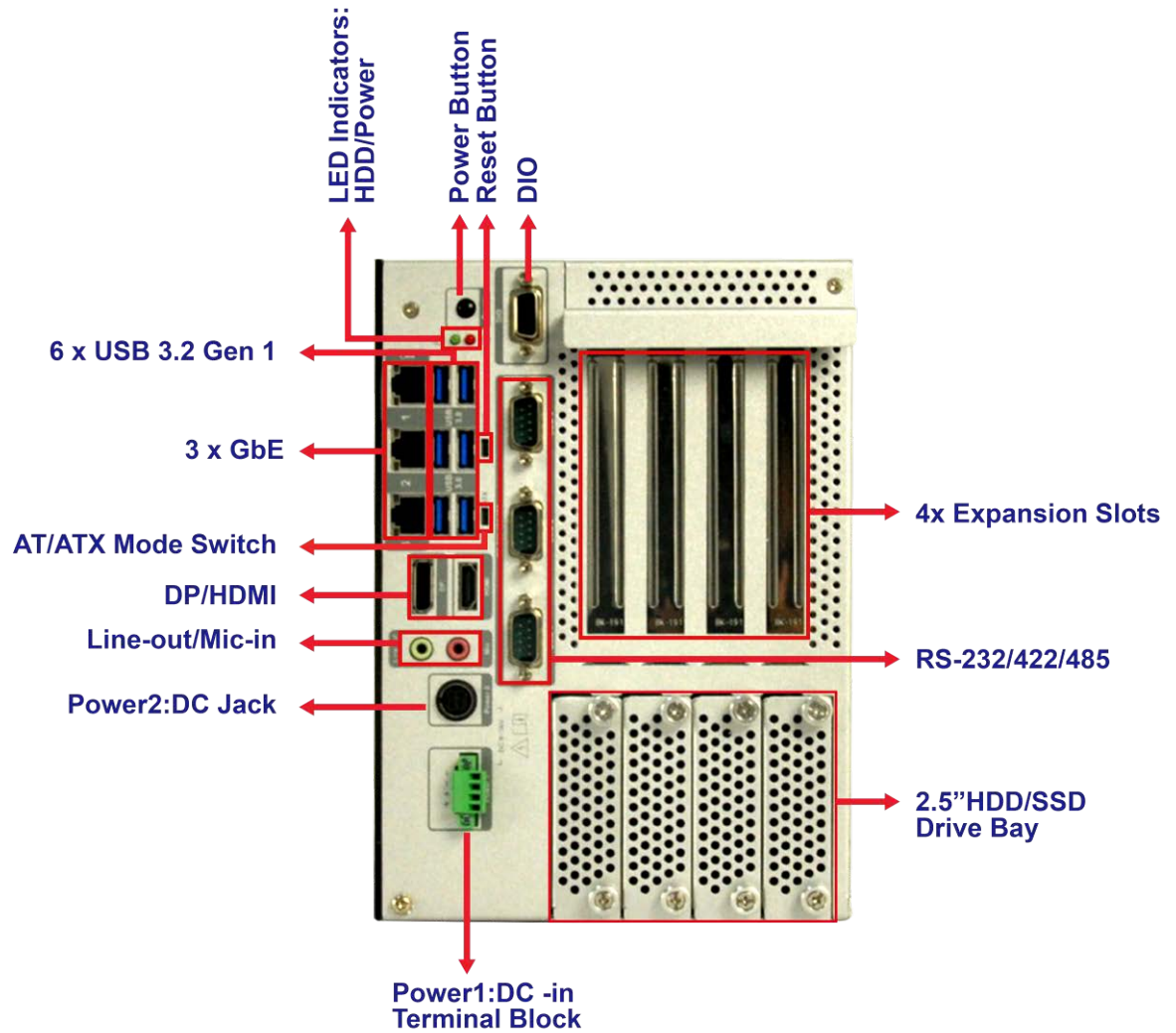

Figure 1-2: Front Panel

TANK-880-Q370

1.6 Rear Panel

The rear panel of the TANK-880-Q370 Series is shown below.



Figure 1-3: Rear Panel

1.7 Physical Dimensions

The physical dimensions of the TANK-880-Q370 Series are shown in **Figure 1-4**.

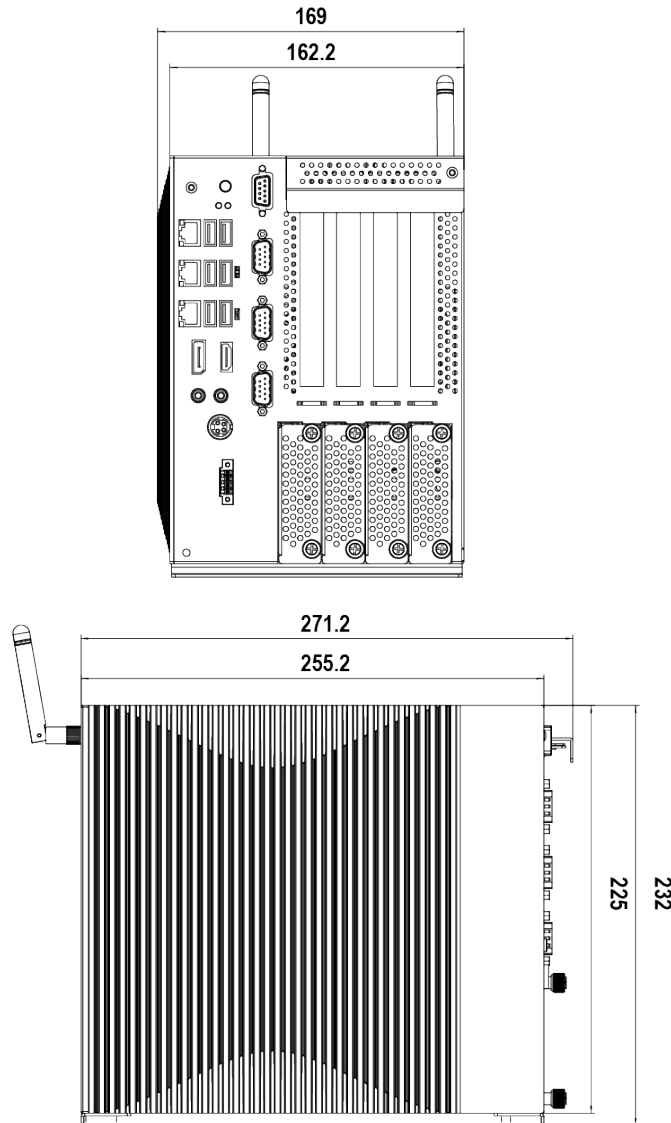

Figure 1-4: Physical Dimensions

Chapter

2

Unpacking

2.1 Anti-static Precautions



WARNING:

Failure to take ESD precautions during installation may result in permanent damage to the TANK-880-Q370 Series and severe injury to the user.

Electrostatic discharge (ESD) can cause serious damage to electronic components, including the TANK-880-Q370 Series. Dry climates are especially susceptible to ESD. It is therefore critical that whenever the TANK-880-Q370 Series or any other electrical component is handled, the following anti-static precautions are strictly adhered to.

- **Wear an anti-static wristband:** Wearing a simple anti-static wristband can help to prevent ESD from damaging the board.
- **Self-grounding:** Before handling the board touch any grounded conducting material. During the time the board is handled, frequently touch any conducting materials that are connected to the ground.
- **Use an anti-static pad:** When configuring the TANK-880-Q370 Series, place it on an anti-static pad. This reduces the possibility of ESD damaging the TANK-880-Q370 Series.

2.2 Unpacking Precautions

When the TANK-880-Q370 Series is unpacked, please do the following:

- Follow the anti-static precautions outlined in **Section 2.1**.
- Make sure the packing box is facing upwards so the TANK-880-Q370 Series does not fall out of the box.
- Make sure all the components shown in **Section 2.2** are present.

TANK-880-Q370



2.3 Unpacking Checklist











NOTE:

If some of the components listed in the checklist below are missing, please do not proceed with the installation. Contact the IEI reseller or vendor you purchased the TANK-880-Q370 Series from or contact an IEI sales representative directly. To contact an IEI sales representative, please send an email to sales@ieiworld.com.

The TANK-880-Q370 Series is shipped with the following components:

Quantity	Item and Part Number	Image
Standard		
1	TANK-880-Q370 Series	
2	Mounting brackets	
1	Chassis screws	

The following table lists the optional items that can be purchased separately.

Optional	
Wi-Fi module (P/N: 27319-000009-RS*)	
External antenna (P/N: 32505-000900-100-RS*)	
RF cable, 250mm (P/N: 32501-004000-100-RS*)	
Power adapter (P/N: 63040-010150-700-RS)	
Power cord (P/N: 32000-000002-RS)	
TPM 2.0 module (P/N: TPM-IN02-R20)	
PCI Express Power over Ethernet card, 4-port 1000 Base(T), 802.3at/af compliant, low profile, RoHS (P/N: GPOE-4P-R20)	
Intel® Vision Accelerator Design with Intel®Movidius™VPU (P/N: Mustang-V100)	

** Each Wi-Fi module needs two antennas and two RF cables to fully support Wi-Fi function.*

Chapter

3

Installation

3.1 Installation Precautions



CAUTION:

The TANK-880-Q370 Series has more than one power supply connection point.

To reduce the risk of electric shock, disconnect all power sources before installing or servicing the TANK-880-Q370 Series.

During installation, be aware of the precautions below:

- **Read the user manual:** The user manual provides a complete description of the TANK-880-Q370 Series, installation instructions and configuration options.
- **DANGER! Disconnect Power:** Power to the TANK-880-Q370 Series must be disconnected during the installation process, or before any attempt is made to access the rear panel. Electric shock and personal injury might occur if the rear panel of the TANK-880-Q370 Series is opened while the power cord is still connected to an electrical outlet.
- **Qualified Personnel:** The TANK-880-Q370 Series must be installed and operated only by trained and qualified personnel. Maintenance, upgrades, or repairs may only be carried out by qualified personnel who are familiar with the associated dangers.
- **Air Circulation:** Make sure there is sufficient air circulation when installing the TANK-880-Q370 Series. The TANK-880-Q370 Series's cooling vents must not be obstructed by any objects. Blocking the vents can cause overheating of the TANK-880-Q370 Series. Leave at least 5 cm of clearance around the TANK-880-Q370 Series to prevent overheating.
- **Grounding:** The TANK-880-Q370 Series should be properly grounded. The voltage feeds must not be overloaded. Adjust the cabling and provide external overcharge protection per the electrical values indicated on the label attached to the back of the TANK-880-Q370 Series.

TANK-880-Q370

3.2 Hard Disk Drive (HDD) Installation

To install the hard drive, please follow the steps below:

- Step 1:** Loosen the two thumbscrews on the front panel and pull out the HDD bracket (Figure 3-1).



Figure 3-1: Unscrew the Cover

- Step 2:** Put the HDD bracket on a flat surface (Figure 3-2).



Figure 3-2: HDD Bracket

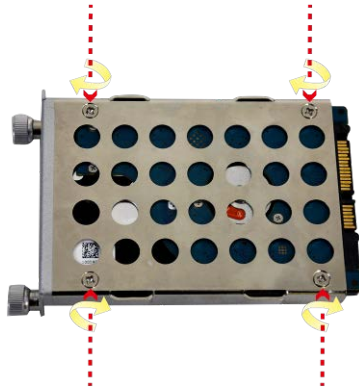

Figure 3-3: HDD Installation

Step 3: Place the hard drive into the hard drive bracket and secure the HDD bracket and secure the hard drive with four screws (**Figure 3-3**).

Step 4: Insert the HDD bracket into the TANK-880-Q370 Series and fasten the two thumbscrews to secure it.

3.3 System Fan Installation

To install the optional system fan, please follow the steps below:

Step 1: Remove the four screws on the rear. Lift the fan bracket and place it on a flat surface (**Figure 3-4**).

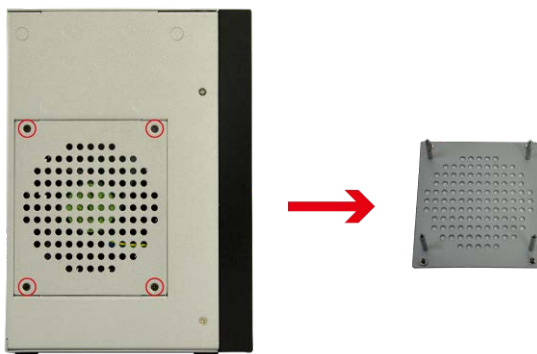

Figure 3-4: Fan Bracket

Step 2: Place a system fan onto the fan bracket and secure it with four retention screws (**Figure 3-5**).

TANK-880-Q370



Figure 3-5: System Fan Installation

Step 3: Connect the system fan cable to the **SYS_FAN1** connector on the motherboard of the TANK-880-Q370 Series.

Step 4: Reinstall the fan bracket into the TANK-880-Q370 Series

3.4 Mounting the System with Mounting Brackets

To mount the embedded system onto a wall or some other surface using the two mounting brackets, please follow the steps below.

Step 1: Turn the embedded system over.

Step 2: Align the three retention screw holes in each bracket with the corresponding retention screw holes on the bottom surface (**Figure 3-6**).

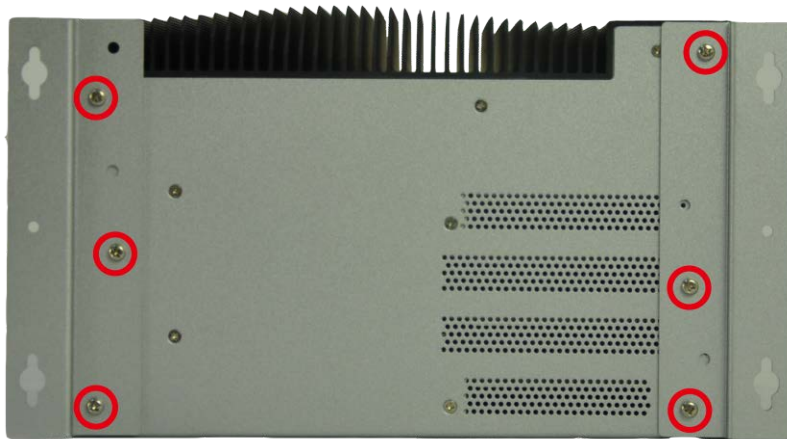

Figure 3-6: Mounting Bracket Retention Screws

- Step 3:** Secure the brackets to the system by inserting two retention screws into each bracket (Figure 3-6).
- Step 4:** Drill holes in the intended installation surface.
- Step 5:** Align the mounting holes in the sides of the mounting brackets with the predrilled holes in the mounting surface.
- Step 6:** Insert four retention screws, three in each bracket, to secure the system to the wall.

3.5 External Peripheral Interface Connectors

The TANK-880-Q370 Series has the following connectors. Detailed descriptions of the connectors can be found in the subsections below.

- AT/ATX power mode switch
- Audio
- Digital I/O
- Ethernet
- Power button
- Power DC jack
- Power terminal block
- HDMI
- DP

TANK-880-Q370

- RS-232/422/485
- USB

3.5.1 AT/ATX Power Mode Selection

The TANK-880-Q370 Series supports AT and ATX power modes. The setting can be made through the AT/ATX power mode switch on the external peripheral interface panel as shown below.

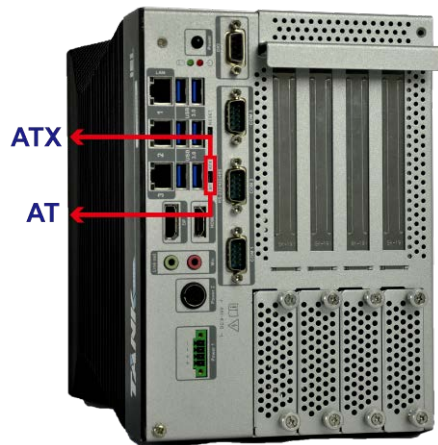

Figure 3-7: AT/ATX Power Mode Switch

3.5.2 Audio Connector

The audio jacks connect to external audio devices.

- **Line Out port (Green):** Connects to a headphone or a speaker. With multi-channel configurations, this port can also connect to front speakers.
- **Microphone (Pink):** Connects a microphone.



Figure 3-8: Audio Connector

3.5.3 Digital Input / Output Connector

The digital I/O connector provides programmable input and output for external devices. The pinouts for the digital I/O connector are listed in the table below.

PIN NO.	DESCRIPTION	PIN NO.	DESCRIPTION
1	IDIN0	2	IDOUT0
3	IDIN1	4	IDOUT1
5	IDIN2	6	IDOUT2
7	IDIN3	8	IDOUT3
9	VCC		

Table 3-1: Digital I/O Connector Pinouts

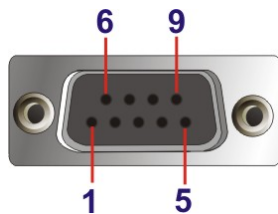

Figure 3-9: DIO Connector

3.5.4 HDMI/DP Connector

To connect the HDMI/DP devices, please plug in HDMI/DP connector in the right direction as shown below:



Figure 3-10: HDMI/DP Connection

TANK-880-Q370

3.5.5 LAN Connectors

The LAN connectors allow connection to an external network.

Step 1: **Locate the RJ-45 connectors.** The locations of the RJ-45 connectors are shown in **Figure 1-2**.

Step 2: **Align the connectors.** Align the RJ-45 connector on the LAN cable with one of the RJ-45 connectors on the TANK-880-Q370 Series. See **Figure 3-11**.

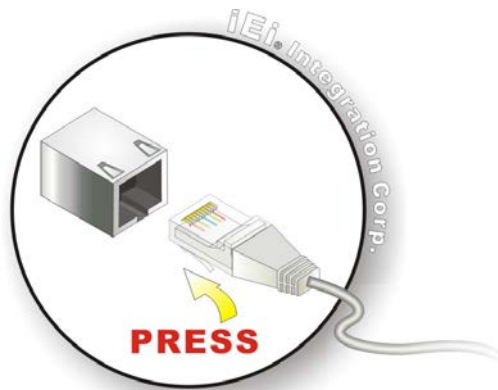

Figure 3-11: LAN Connection

Step 3: **Insert the LAN cable RJ-45 connector.** Once aligned, gently insert the LAN cable RJ-45 connector into the on-board RJ-45 connector.



Figure 3-12: RJ-45 Ethernet Connector

The RJ-45 Ethernet connector has two status LEDs, one green and one yellow. The green LED indicates activity on the port and the yellow LED indicates the port is linked. See **Table 3-2**.

Activity/Link LED		Speed LED	
STATUS	DESCRIPTION	STATUS	DESCRIPTION
Off	No link	Off	10 Mbps connection
Yellow	Linked	Green	100 Mbps connection
Blinking	TX/RX activity	Orange	1 Gbps connection

Table 3-2: RJ-45 Ethernet Connector LEDs

3.5.6 Power Input, 4-pin Terminal Block

The power connector connects the leads of a 9 V~36 V DC power supply into the terminal block. Make sure that the power and ground wires are attached to the correct sockets of the connector.

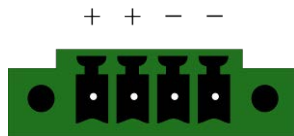

Figure 3-13: 4-pin Terminal Block

3.5.7 Power Input, 4-pin DIN Connector

The power connector connects to the 9 V~36 V DC power adapter.

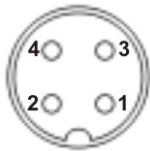

Figure 3-14: Power Input Connector

TANK-880-Q370

3.5.8 DB-9 RS-232/422/485 Serial Port Connectors

The system has three RS-232/422/485 serial port connectors. The pinouts for the serial ports are listed in the table below.

PIN NO.	RS232	RS422	RS485
1	DCD#	TX-	TX-
2	RXD	TX+	TX+
3	TXD	RX+	
4	DTR#	RX-	
5	GND		
6	DSR#		
7	RTS#		
8	CTS#		
9	RI#		

Table 3-3: RS-232/422/485 Connector (COM1~COM3)

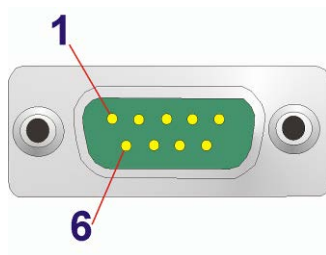

Figure 3-15: DB-9 RS-232/422/485 Serial Port Connector

3.6 Internal Peripheral Interface Connectors

3.6.1 iDP Module Installation

Through the IEI iDP converter cards, the iDP connector can support different display specifications, such as VGA, HDMI, DVI-D, LVDS and DisplayPort. To connect an iDP module to TANK-880-Q370 Series please follow the instructions below.

Step 1: Loosen one screw on the front panel and the top six screws, slide the cover outwards and then lift the cover up gently (Figure 3-16).



Figure 3-16: iDP Module with Bracket

Step 2: Locate the internal DisplayPort connector. The location of the internal DisplayPort connector is shown in Figure 3-17

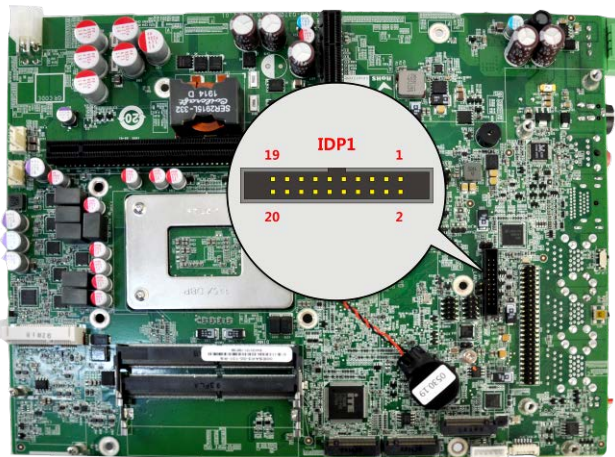

Figure 3-17: Internal DisplayPort Connector Location

Step 3: Secure the iDP module with the bracket by tightening the two retention screws on either side of the iDP module.(Figure 3-18)

TANK-880-Q370

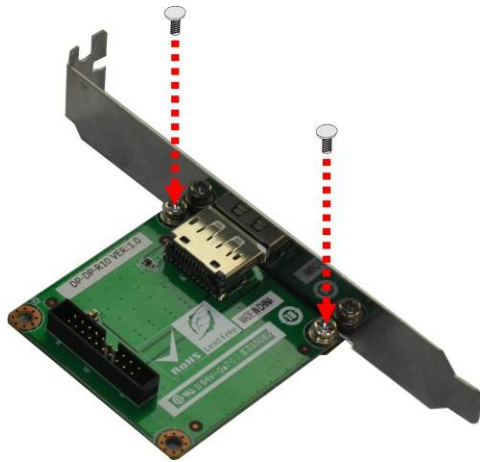

Figure 3-18: iDP Module with Bracket

Step 4: Connect the iDP module to the DisplayPort connector on the motherboard. See Figure 3-19



Figure 3-19: iDP Module Installation

Step 5: Remove the retention screws on the expansion slot bracket. See Figure 3-20



Figure 3-20: Remove Expansion Slot Bracket

Step 6: Secure the iDP module with bracket to the system.

Step 7: Reinstall the cover.

TANK-880-Q370



WARNING:

Installing the iDP module will occupy one expansion slot.

The following table lists the iDP converter cards that can be installed to the system.





<p>DisplayPort to HDMI converter board (for IEI iDP connector) (P/N: DP-HDMI-R10)</p>	
<p>DisplayPort to LVDS converter board (for IEI iDP connector) (P/N: DP-LVDS-R10)</p>	
<p>DisplayPort to VGA converter board (for IEI iDP connector) (P/N: DP-VGA-R10)</p>	
<p>DisplayPort to DVI-D converter board (for IEI iDP connector) (P/N: DP-DVI-R10)</p>	
<p>DisplayPort to DisplayPort converter board (for IEI iDP connector) (P/N: DP-DP-R10)</p>	

Table 3-4: iDP Converter Cards

3.7 Powering On/Off the System



WARNING:

Make sure a power supply with the correct input voltage is being fed into the system. Incorrect voltages applied to the system may cause damage to the internal electronic components and may also cause injury to the user.

- **Power on** the system: press the power button for 3 seconds
- **Power off** the system: press the power button for 6 seconds
- The power of this system can be less than 250w-20A.



Figure 3-21: Power Button

3.8 Power

There are two power connectors on the rear panel. Power 1 connector is a 3-pin terminal block that supports ACC On signal. Power 2 connector is a DIN connector that can directly connect to a power adapter. The supported power input voltages are:

- **Power 1 (terminal block):** 9 V ~ 36 V
- **Power 2 (DC jack):** 9 V ~ 36 V

TANK-880-Q370

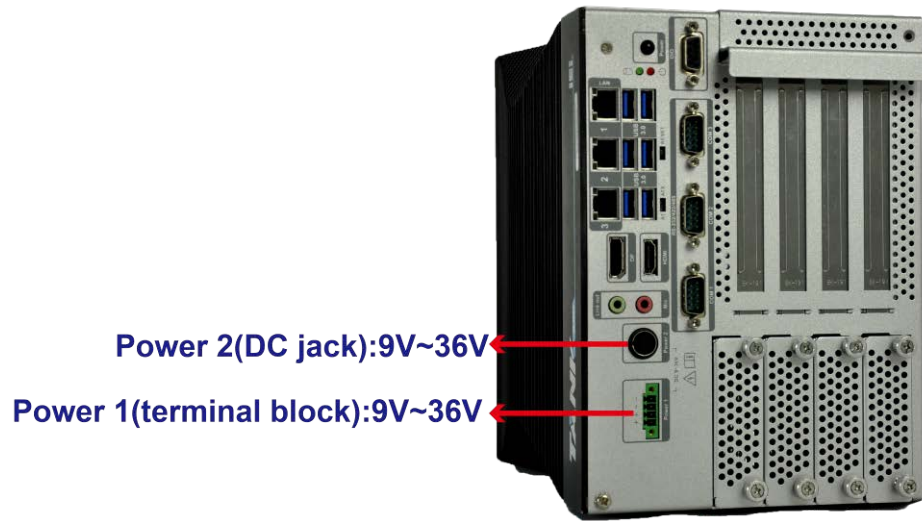

Figure 3-22: Power Connectors

LED Indicator	Description
Power LED1 (Breathing Orange)	Standby mode.
Power LED2 (Solid blue)	Power-on mode.

Table 3-5: Power LED Indicators Description



NOTE:

The power LED turns off when the power cable is unplugged from the system.

3.9 Available Drivers

All the drivers for the TANK-880-Q370 Series are available on IEI Resource Download Center (<https://download.ieiworld.com>). Type TANK-880-Q370 Series and press Enter to find all the relevant software, utilities, and documentation.

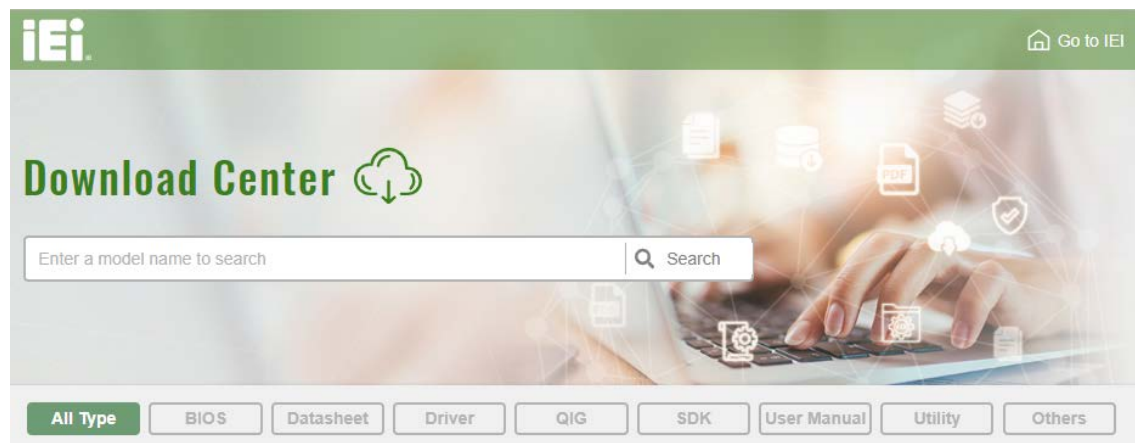
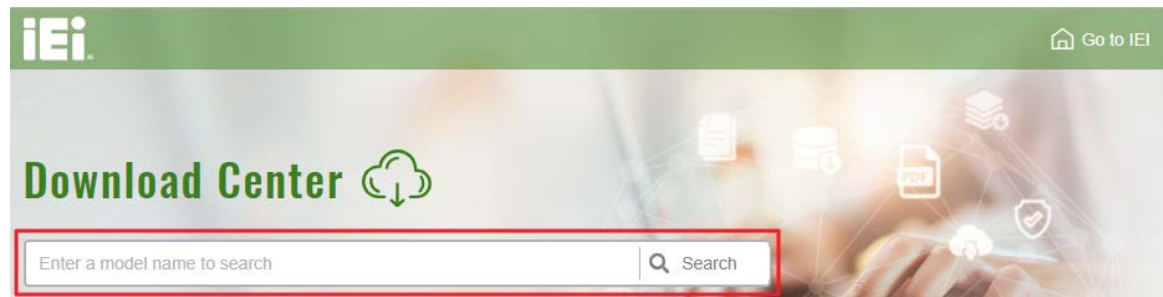

Figure 3-23: IEI Resource Download Center

3.10 Driver Download

To download drivers from IEI Resource Download Center, follow the steps below.

Step 1: Go to <https://download.ieiworld.com>. Type TANK-880-Q370 Series and press Enter.



Step 2: All product-related software, utilities, and documentation will be listed. You can choose **Driver** to filter the result.

TANK-880-Q370

[All Type](#)
[BIOS](#)
[Datasheet](#)
[Driver](#)
[QIG](#)
[SDK](#)
[User Manual](#)
[Utility](#)
[Others](#)

WAFER-BT-i1 [Product Info](#)

[Embedded Computer](#) ▶ [Single Board Computer](#) ▶ [Embedded Board](#)
 3.5" SBC with Intel® 22nm Atom™/Celeron® on-board SoC

Driver

File Name	Published	Version	File Checksum
7B000-001033-RS V2.3.iso (2.23 GB)	2017/10/03	2.30	3B2DB1F792779A93A8F50DDBC3943E30

Step 3: Click the driver file name on the page and you will be prompted with the following window. You can download the entire ISO file (❶), or click the small arrow to find an individual driver and click the file name to download (❷).

7B000-001168-RS_V1.4.iso

❶ [Click here to download entire ISO file. \(2.99 GB\)](#)

* Download individual file *

- Docs
 - 1.Chipset
 - 10.1.1.12.zip (2.7 MB)
 - 2.VGA
 - 3.Audio
 - 4.Lan
 - 5.USB 3.0
 - 6.Serial IO
 - 7.TXE
 - 8.Manual



NOTE:

To install software from the downloaded ISO image file in Windows 8, 8.1 or 10, double-click the ISO file to mount it as a virtual drive to view its content.

Chapter

4

System Motherboard

TANK-880-Q370

4.1 Overview

This chapter details all the jumpers and connectors of the system motherboard.

4.1.1 Layout

The figures below show all the connectors and jumpers of the system motherboard.

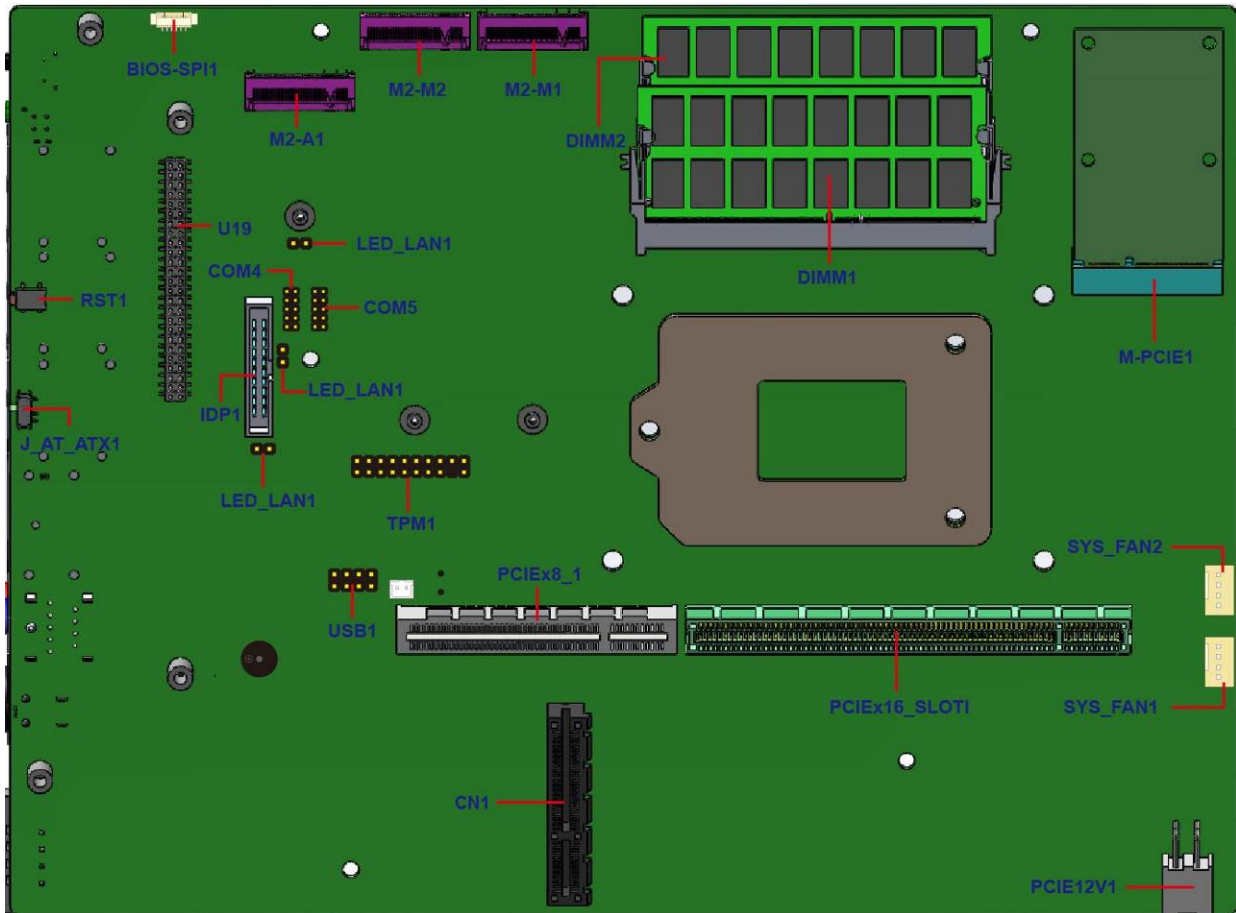

Figure 4-1: System Motherboard (Front)

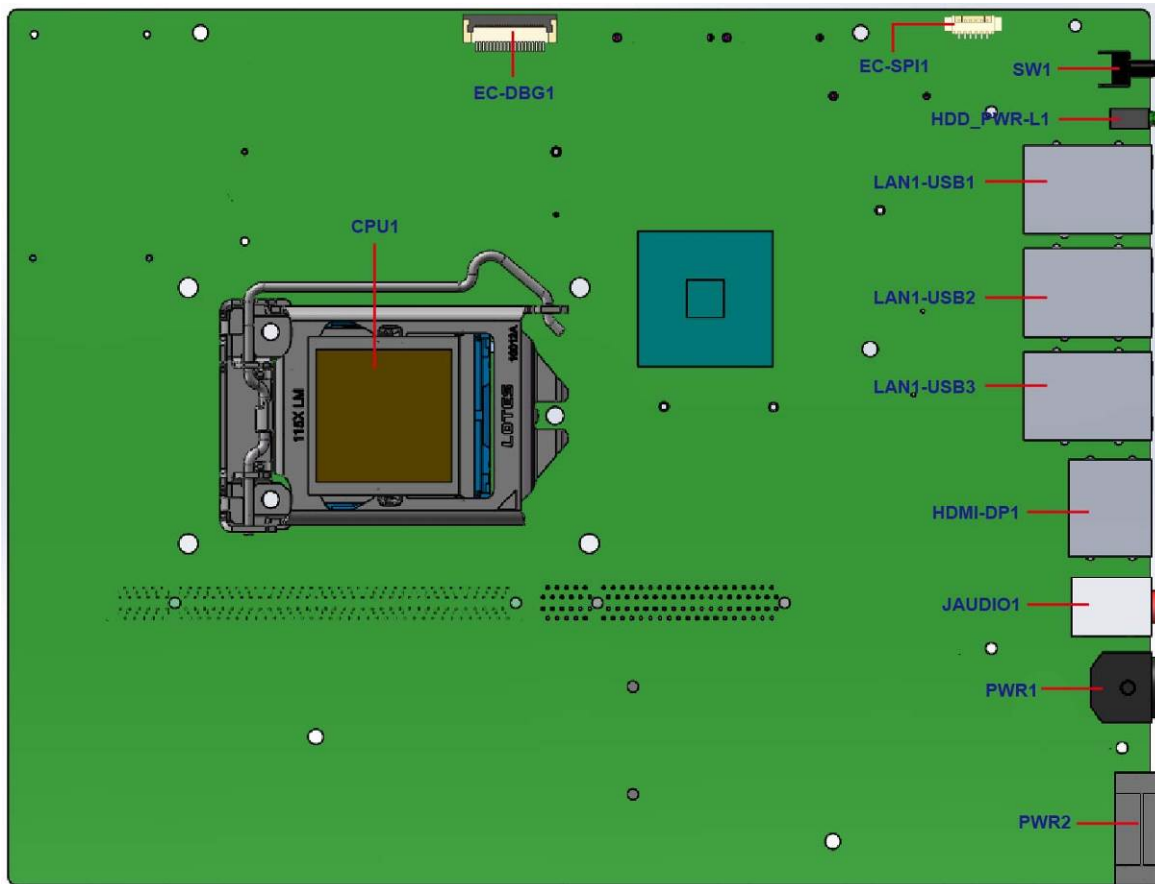

Figure 4-2: System Motherboard (Rear)

4.2 Internal Peripheral Connectors

The table below shows a list of the internal peripheral interface connectors on the system motherboard. Pinouts of these connectors can be found in the following sections.

Connector	Type	Label
Clear CMOS Switch	4-pin Switch	J_CMOS1
AT/ATX mode switch	2-pin Switch	J_AT_ATX1
RS-232 connector	10-pin Header	COM4
RS-232 connector	10-pin Header	COM5
Dual USB 2.0 connector	8-pin Header	USB1
TPM connector	20-pin box header	TPM1

TANK-880-Q370

Connector	Type	Label
Power button connector	2-pin header	PWR_BTN1
BIOS programmer connector	6-pin box header	J_SPI1
EC programmer connector	2-pin header	J_EC1
EC debug card connector	20-pin box header	EC_DBG1
System fan connector	4-pin wafer	SYS_FAN1, SYS_FAN2
PCIe power input connector	4-pin Connector	PCIE12V1
iDP connector	20-pin box header	IDP1
LAN LED connector	2-pin header	LED_LAN1, LED_LAN2, LED_LAN3
USB DOM connector	8-pin Connector	SBM3:USB_DOM1
Battery connector	8-pin header	BAT1
M.2 slot (PCIe x2 interface)	M.2 M-key slot	M2_M1/M2_M2
M.2 slot (PCIe x2 /USB interface)	M.2 A-key slot	M2_A1
Mini PCIe/MSATA MUX Connector	Full-size PCIe Mini	M-PCIE1
DDR4 memory slot	DDR4 memory slot	DIMM1, DIMM2
HDD+System LED	HDD+System LED	HDD_PSR_L1
SBM3 (TANK-880-SSDBP) HDD backplane connector	SBM3 backplane connector	CN1
SBL7 (HPE-4S88-R10) PCIe backplane connector	SBL7 backplane connector	PCIEX16_SLOT1, PCIEX8_1
PCIe x16 slot	PCIe x16	SBL7: PCIEX16_SLOT1
PCIe x4 slot	PCIe x4	SBL7: PCIEX4_1, PCIEX4_2
PCIe x1 slot	PCIe x1	SBL7: PCIEX1_1

Table 4-1: Peripheral Interface Connectors

4.2.1 Clear CMOS Switch (J_CMOS1)

PIN NO.	DESCRIPTION
Open	Normal Operation (Default)
Push	Clear CMOS Setup

Table 4-2: Clear CMOS Switch (J_CMOS1)

4.2.2 AT/ATX Mode Switch (J_AT_ATX1)

PIN NO.	DESCRIPTION
Short 1 - 2	ATX Mode (default)
Short 2- 3	AT Mode

Table 4-3: AT/ATX Mode Switch (J_AT_ATX1)

4.2.3 BIOS Programming Connector (JSPI1)

PIN NO.	DESCRIPTION	PIN NO.	DESCRIPTION
1	VCC3V	2	CS
3	MISO	4	CLK
5	MOSI	6	GND

Table 4-4: BIOS Programming Connector Pinouts (JSPI1)

4.2.4 RS-232 Pin Header (COM4)

PIN NO.	DESCRIPTION	PIN NO.	DESCRIPTION
1	NDCD4	2	NDSR4
3	NRX4	4	NRTS4
5	NTX4	6	NCTS4
7	NDTR4	8	NRI4
9	GND	10	GND

Table 4-5: RS-232 Pin Header (COM4)

4.2.5 RS-232 Pin Header (COM5)

PIN NO.	DESCRIPTION	PIN NO.	DESCRIPTION
1	NDCD5	2	NDSR5
3	NRX5	4	NRTS5
5	NTX5	6	NCTS5
7	NDTR5	8	NR15
9	GND	10	GND

Table 4-6: RS-232 Pin Header (COM5)

4.2.6 Dual USB 2.0 Pin Header (USB1)

PIN NO.	DESCRIPTION	PIN NO.	DESCRIPTION
1	SB5V	11	GND
2	DATA-	12	DATA+
3	DATA+	13	DATA-
4	GND	14	SB5V

Table 4-7: Dual USB 2.0 Pin Header (USB1)

4.2.7 TPM Pin Header (TPM1)

PIN NO.	DESCRIPTION	PIN NO.	DESCRIPTION
1	CLOCK	2	GND
3	FRAME	4	NC
5	RESET	6	VCC5V
7	LAD3	8	LAD2
9	VCC3V	10	LAD1
11	LAD0	12	GND
13	SMB_CLK	14	SMB_DATA
15	SB3V	16	SERIRQ
17	GND	18	CLKRUN
19	LPCPD	20	DRQ

Table 4-8: TPM Pin Header (TPM1)

4.2.8 Power Button Pin Header (PWR_BTN1)

PIN NO.	DESCRIPTION	PIN NO.	DESCRIPTION
1	PWRBTN_SW#	2	GND

Table 4-9: Power Button Pin Header (PWR_BTN1)

4.2.9 BIOS Programmer Connector (J_SPI1)

PIN NO.	DESCRIPTION	PIN NO.	DESCRIPTION
1	VCC3V	2	CS
3	MISO	4	CLK
5	MOSI	6	GND

Table 4-10: BIOS Programmer Connector (J_SPI1)

4.2.10 EC Programmer Connector (J_EC1)

PIN NO.	DESCRIPTION	PIN NO.	DESCRIPTION
1	VCC3V	2	CS
3	MISO	4	CLK
5	MOSI	6	GND

Table 4-11: EC Programmer Connector (J_EC1)

4.2.11 EC Debug Card Connector (EC_DBG1)

PIN NO.	DESCRIPTION	PIN NO.	DESCRIPTION
1	KSI0	2	KSO0
3	KSO1	4	KSO2
5	KSO3	6	KSO4
7	KSO5	8	KSO6
9	KSO7	10	KSO8
11	KSO9	12	KSO10
13	KSO12	14	KSI1
15	KSO11	16	KSI2
17	KSI3	18	GND
19	GND	20	GND

Table 4-12: EC Debug Card Connector (EC_DBG1)

4.2.12 System Fan Connectors (SYS_FAN1/SYS_FAN2)

PIN NO.	DESCRIPTION	PIN NO.	DESCRIPTION
1	GND	2	VCC12V
3	FANIO	4	PWM

Table 4-13: System Fan Connectors (SYS_FAN1/SYS_FAN2)

4.2.13 PCIe Power Input Connector (PCIE12V1)

PIN NO.	DESCRIPTION	PIN NO.	DESCRIPTION
1	GND	2	GND
3	VCC12V	4	VCC12V

Table 4-14: PCIe Power Input Connector (PCIE12V1)

4.2.14 iDP Connector (IDP1)

PIN NO.	DESCRIPTION	PIN NO.	DESCRIPTION
1	HPD#	2	AUXP
3	GND	4	AUXN
5	DET_D	6	GND
7	GND	8	LANE2P
9	LANE3P	10	LANE2N
11	LANE3N	12	GND
13	GND	14	LANE0P
15	LANE1P	16	LANE0N
17	LANE1N	18	VCC3V
19	VCC5V	20	NC

Table 4-15: iDP Connector (IDP1)

4.2.15 LAN LED Connector (LED_LAN1/LED_LAN2/LED_LAN3)

PIN NO.	DESCRIPTION	PIN NO.	DESCRIPTION
1	VCC3V	2	ACT

Table 4-16: LAN LED Connector

4.2.16 USB DOM Connector (SBM3: USB_DOM1)

PIN NO.	DESCRIPTION	PIN NO.	DESCRIPTION
1	VCC5V	2	NC
3	DATA-	4	NC
5	DATA+	6	NC
7	GND	8	NC

Table 4-17: USB DOM Connector (SBM3: USB_DOM1)

TANK-880-Q370

4.2.17 Battery Connector

PIN NO.	DESCRIPTION	PIN NO.	DESCRIPTION
1	VBATT	2	GND

Table 4-18: Battery Connector (BAT1)

4.3 External Interface Panel Connectors

The table below shows a list of the external interface panel connectors on the system motherboard. Pinouts of these connectors can be found in the following sections.

Connector	Type	Label
Audio Line-In/Out MIC Connector	Audio jack	JAUDIO1
DP and HDMI combo Connector	DisplayPort, HDMI	HDMI_DP1
Digital I/O Connector	DB-9	IO1
Ethernet and USB 3.2 Gen 1 combo connectors	RJ-45, USB 3.2 Gen 1 Type A	LAN1_USB1, LAN1_USB2, LAN1_USB3
Power input connector	4-pin DC jack	PWR1
Power input connector	3-pin terminal block	PWR2
RS-232/422/485 connector	DB-9	COM1, COM2, COM3

Table 4-19: Rear Panel Connectors

4.3.1 LAN Connectors

Pin	Description	Pin	Description
1	MDIA3-	5	MDIA1+
2	MDIA3+	6	MDIA2+
3	MDIA2-	7	MDIA0-
4	MDIA1-	8	MDIA0+

Table 4-20: Ethernet Connector Pinouts

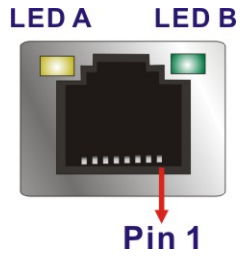

Figure 4-3: Ethernet Connector

LED	Description	LED	Description
A	on: linked blinking: data is being sent/received	B	off: 10 Mb/s green: 100 Mb/s orange: 1000 Mb/s

Table 4-21: Connector LEDs

4.3.2 Power Input Connector, DC Jack (PWR1)

PIN NO.	DESCRIPTION	PIN NO.	DESCRIPTION
1	DC_IN1	2	GND
3	DC_IN1	4	GND
5	GND		

Table 4-22: Power Input Connector (PWR1)

4.3.3 Power Input Connector, Terminal Block (PWR2)

PIN NO.	DESCRIPTION	PIN NO.	DESCRIPTION
1	DC_IN2	2	DC_IN2
3	GND	4	GND

Table 4-23: Power Input Connector (PWR2)

TANK-880-Q370

Chapter

5

BIOS

5.1 Introduction

The BIOS is programmed onto the BIOS chip. The BIOS setup program allows changes to certain system settings. This chapter outlines the options that can be changed.



NOTE:

Some of the BIOS options may vary throughout the life cycle of the product and are subject to change without prior notice.

5.1.1 Starting Setup

The UEFI BIOS is activated when the computer is turned on. The setup program can be activated in one of two ways.

1. Press the **DEL** or **F2** key as soon as the system is turned on or
2. Press the **DEL** or **F2** key when the “**Press DEL or F2 to enter SETUP**” message appears on the screen.

If the message disappears before the **DEL** or **F2** key is pressed, restart the computer and try again.

5.1.2 Using Setup

Use the arrow keys to highlight items, press **ENTER** to select, use the PageUp and PageDown keys to change entries, press **F1** for help and press **ESC** to quit. Navigation keys are shown in.

Key	Function
Up arrow	Move to previous item
Down arrow	Move to next item
Left arrow	Move to the item on the left hand side
Right arrow	Move to the item on the right hand side
+	Increase the numeric value or make changes

TANK-880-Q370

Key	Function
-	Decrease the numeric value or make changes
Page Up key	Increase the numeric value or make changes
Page Dn key	Decrease the numeric value or make changes
Esc key	Main Menu – Quit and not save changes into CMOS Status Page Setup Menu and Option Page Setup Menu -- Exit current page and return to Main Menu
F1	General help, only for Status Page Setup Menu and Option Page Setup Menu
F2	Previous values
F3	Load optimized defaults
F4	Save changes and Exit BIOS

Table 5-1: BIOS Navigation Keys

5.1.3 Getting Help

When **F1** is pressed a small help window describing the appropriate keys to use and the possible selections for the highlighted item appears. To exit the Help Window press **ESC** or the **F1** key again.

5.1.4 Unable to Reboot after Configuration Changes

If the computer cannot boot after changes to the system configuration is made, CMOS defaults. Use the jumper described in Chapter 2.

5.1.5 BIOS Menu Bar

The **menu bar** on top of the BIOS screen has the following main items:

- Main – Changes the basic system configuration.
- Advanced – Changes the advanced system settings.
- Chipset – Changes the chipset settings.
- Boot – Changes the system boot configuration.
- Security – Sets User and Supervisor Passwords.

- Save & Exit – Selects exit options and loads default settings.

The following sections completely describe the configuration options found in the menu items at the top of the BIOS screen and listed above.

TANK-880-Q370

5.2 Main

The **Main** BIOS menu (**BIOS Menu 1**) appears when the **BIOS Setup** program is entered. The **Main** menu gives an overview of the basic system information.

Aptio Setup Utility - Copyright (C) 2016 American Megatrends, Inc.						
Main	Advanced	Chipset	Security	Boot	Save & Exit	Server Mgmt
BIOS Information						
BIOS Vendor	American Megatrends			Set the Date. Use Tab to switch between Data elements.		
Core Version	5.13					
Compliancy	UEFI 2.7; PI 1.6					
Project Version	SER0AR10.Bin					
Build Date and time	10/18/2019 13:59:45					
Access Level	Administrator					
iWDD Vendor	iEi					
iWDD Version	SER0ER10.bin					
Processor Information						
Name	CoffeeLake DT					
Type	Intel(R) Core(TM)					
	i7-6700E CPU @ 2.40GHz					
Speed	2400 MHz					
ID	0X96EA					
Stepping	U0					
Number of Processors	6Core(s)/12Thread(s)					
Microcode Revision	B4					
IGFX VBIOS Version	1017					
Total Memory	8192 MB					
Memory Frequency	2667 MHz					
PCH Information						
Name	CNL PCH-H					
PCH SKU	Q370					
Stepping	B0					
ME FW Version	12.0.35.1427					
ME Firmware	SKUCorporate SKU					
System Date	[Mon 12/01/2019]					
System Time	[15:43:27]					

←→: Select Screen						
↑↓: Select Item						
Enter>Select						
+/-: Change Opt.						
F1: General Help						
F2: Previous Values						
F3: Optimized Defaults						
F4: Save & Exit						
ESC: Exit						
Version 2.17.1255. Copyright (C) 2016 American Megatrends, Inc.						

BIOS Menu 1: Main

The Main menu has two user configurable fields:

→ **System Date [xx/xx/xx]**

Use the **System Date** option to set the system date. Manually enter the day, month and year.

→ **System Time [xx:xx:xx]**

Use the **System Time** option to set the system time. Manually enter the hours, minutes and seconds.

TANK-880-Q370

5.3 Advanced

Use the **Advanced** menu (**BIOS Menu 2**) to configure the CPU and peripheral devices through the following sub-menus:

**WARNING!**

Setting the wrong values in the sections below may cause the system to malfunction. Make sure that the settings made are compatible with the hardware.

```

Aptio Setup Utility - Copyright (C) 2016 American Megatrends, Inc.
  Advanced
> CPU Configuration
> PCH-FW Configuration
> ACPI Settings
> F81866 Super IO Configuration
> iWDD H/W Monitor
> Serial Port Console Redirection
> USB Configuration
> NVMe Configuration
> iEi Feature

Trusted Computing
Settings

-----
-><: Select Screen
↑↓: Select Item
Enter>Select
+/-: Change Opt.
F1: General Help
F2: Previous Values
F3: Optimized Defaults
F4: Save & Exit
ESC: Exit

Version 2.17.1255. Copyright (C) 2016 American Megatrends, Inc.

```

BIOS Menu 2: Advanced

5.3.1 CPU Configuration

Use the **CPU Configuration** menu (**BIOS Menu 3**) to enter the **CPU Information** submenu or enable Intel Virtualization Technology.

```

Aptio Setup Utility - Copyright (C) 2016 American Megatrends, Inc.
  Advanced
CPU Configuration
Type                Intel(R) Core(TM)
                   i7-8700T CPU@2.40GHZ
ID                 0x906A
L1 Data Cache      32 kB x 6
L1 Code Cache      32 kB x 6
L2 Cache           256 kB x 6
L3 Cache           12 MB
L4 Cache           Not Present
VMX                Supported
SMX/TXT            Supported

Tcc Activation Offset      0
Intel(R) SpeedStep(tm)    [Enabled]
C states                   [Disabled]
Active Processor Cores    [All]
Hyper-Threading           [Enabled]
Intel Trusted Execution Technology [Disabled]
Intel(VMX)Virtualization Technology [Enabled]

-----
<->: Select Screen
^ v: Select Item
Enter>Select
+/-: Change Opt.
F1:  General Help
F2:  Previous Values
F3:  Optimized Defaults
F4:  Save & Exit
ESC: Exit

Version 2.17.1255. Copyright (C) 2016 American Megatrends, Inc.
  
```

BIOS Menu 3: CPU Configuration

➔ EIST [Enabled]

Use the **EIST** option to enable or disable Enhanced Intel SpeedStep® Techonology (EIST).

➔ Disabled

Disables Enhanced Intel SpeedStep® Techonology.

TANK-880-Q370

→ **Enabled** **DEFAULT** Enables Enhanced Intel SpeedStep®
Technology.

→ **Hyper-threading [Enabled]**

Use the **Hyper-threading** BIOS option to enable or disable the Intel Hyper-Threading Technology.

→ **Disabled** Disables the Intel Hyper-Threading Technology.

→ **Enabled** **DEFAULT** Enables the Intel Hyper-Threading Technology.

→ **Active Processor Cores [All]**

Use the **Active Processor Cores** option to configure the number of the active processor cores.

→ **All** **DEFAULT** Active all of the processor cores

→ **1** Active one of the processor cores

→ **2** Active two of the processor cores

→ **3** Active three of the processor cores

→ **Intel Virtualization Technology [Disabled]**

Use the **Intel Virtualization Technology** option to enable or disable virtualization on the system. When combined with third party software, Intel Virtualization technology allows several OSs to run on the same system at the same time.

→ **Disabled** **DEFAULT** Disables Intel Virtualization Technology.

→ **Enabled** Enables Intel Virtualization Technology.

→ **EIST [Enabled]**

Use the **EIST** option to enable or disable the Intel Speed Step Technology.

→ **Disabled** Disables the Intel Speed Step Technology.

→ **Enabled** **DEFAULT** Enables the Intel Speed Step Technology.

→ **C states [Disabled]**

Use the **C states** option to enable or disable CPU C states.

→ **Disabled** **DEFAULT** Disables CPU C states.

→ **Enabled** Enables CPU C states.

→ **Intel TXT(LT) Support [Disabled]**

Use the **Intel TXT(LT) Support** option to enable or disable the Intel® Trusted Execution Technology.

→ **Disabled** **DEFAULT** Disables the Intel® Trusted Execution Technology.

→ **Enabled** Enables the Intel® Trusted Execution Technology.

TANK-880-Q370

5.3.2 PCH-FW Configuration

The **PCH-FW Configuration** menu (**BIOS Menu 4**) allows Intel® Active Management Technology (AMT) options to be configured

```

Aptio Setup Utility - Copyright (C) 2019 American Megatrends, Inc.
  Advanced
AMT BIOS Features          [Enabled]
Unconfigure ME             [Disabled]
OEMFlag Bit 15:
Uncomfigure ME with
resetting MEBx password to
default.

-----
←→: Select Screen
↑↓: Select Item
EnterSelect
F1   General Help
F2   Previous Values
F3   Optimized Defaults
F4   Save
ESC  Exit

Version 2.20.1271. Copyright (C) 2019 American Megatrends, Inc.
    
```

BIOS Menu 4: PCH-FW Configuration

→ AMT BIOS Features [Enabled]

Use **AMT BIOS Features** option to enable or disable the Intel® AMT function.

- **Disabled** Intel® AMT is disabled
- **Enabled** **DEFAULT** Intel® AMT is enabled

→ Unconfigure ME [Disabled]

Use the **Unconfigure ME** option to perform ME unconfigure without password operation.

- **Disabled** **DEFAULT** Not perform ME unconfigure
- **Enabled** To perform ME unconfigure

5.3.3 Trusted Computing

Use the **Trusted Computing** menu (**BIOS Menu 5**) to configure settings related to the Trusted Computing Group (TCG) Trusted Platform Module (TPM).

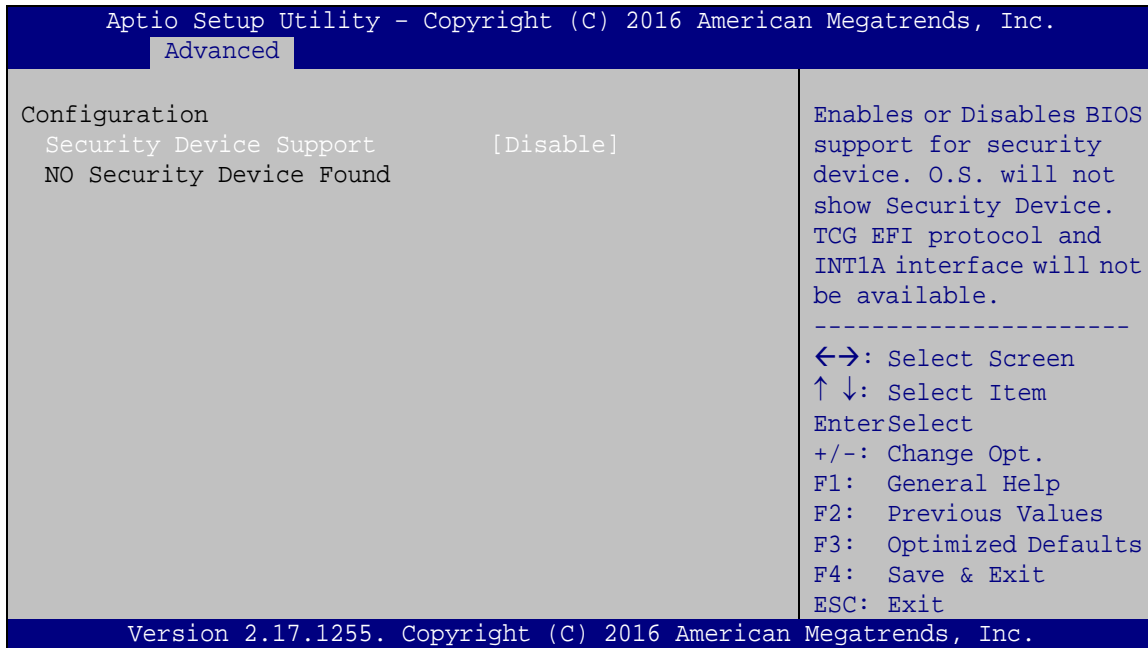

BIOS Menu 5: Trusted Computing

➔ Security Device Support [Disable]

Use the **Security Device Support** option to configure support for the security device.

- ➔ **Disable** **DEFAULT** Security device support is disabled.
- ➔ **Enable** Security device support is enabled.

TANK-880-Q370

5.3.4 ACPI Settings

The ACPI Settings (**BIOS Menu 6**) configures the Advanced Configuration and Power Interface (ACPI) options.

```

Aptio Setup Utility - Copyright (C) 2016 American Megatrends, Inc.
  Advanced
ACPI Settings
ACPI Sleep State          [S3 (Suspend to RAM)]
                                                                    Enable/Disable Intel (R)
                                                                    Active Management
                                                                    Technology BIOS
                                                                    Extension.
                                                                    Note: iAMT H/W is always
                                                                    enabled.
                                                                    This option just controls
                                                                    the BIOS extension
                                                                    execution.
                                                                    -----
                                                                    ←→: Select Screen
                                                                    ↑ ↓: Select Item
                                                                    EnterSelect
                                                                    F1   General Help
                                                                    F2   Previous Values
                                                                    F3   Optimized Defaults
                                                                    F4   Save
                                                                    ESC  Exit
Version 2.17.1255. Copyright (C) 2016 American Megatrends, Inc.

```

BIOS Menu 6: AMT Configuration

→ ACPI Sleep State [S3 (Suspend to RAM)]

Use the **ACPI Sleep State** option to specify the sleep state the system enters when it is not being used.

→ Suspend Disabled

→ S1 (CPU Stop Clock)

The system enters S1(POS) sleep state. The system appears off. The CPU is stopped; RAM is refreshed; the system is running in a low power mode.

→ S3 (Suspend to DEFAULT RAM)

The caches are flushed and the CPU is powered off. Power to the RAM is maintained. The computer returns slower to a working state, but more power is saved.

5.3.5 RTC Wake Settings

The RTC Wake Settings menu (**BIOS Menu 7**) configures RTC wake event.

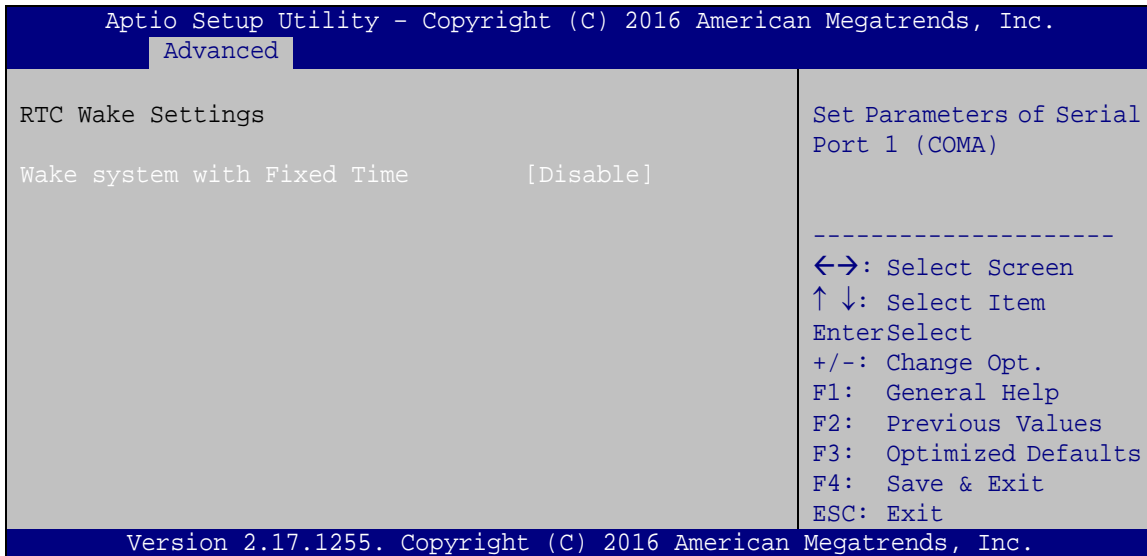

BIOS Menu 7: F81866 Super IO Configuration

→ Wake System with Fixed Time [Disabled]

Use the **Wake System with Fixed Time** option to specify the time the system should be roused from a suspended state.

- **Disabled** **DEFAULT** The real time clock (RTC) cannot generate a wake event
- **Enabled** If selected, the following appears with values that can be selected:
 - *Wake up every day
 - *Wake up date
 - *Wake up hour
 - *Wake up minute
 - *Wake up second

After setting the alarm, the computer turns itself on from a suspend state when the alarm goes off.

TANK-880-Q370

5.3.6 F81866 Super IO Configuration

Use the F81866 Super IO Configuration menu (**BIOS Menu 8**) to set or change the configurations for the FDD controllers, parallel ports and serial ports.

```

Aptio Setup Utility - Copyright (C) 2016 American Megatrends, Inc.
  Advanced
F81866 Super IO Configuration
Super IO Chip                F81866
> Serial Port 1 Configuration
> Serial Port 2 Configuration
> Serial Port 3 Configuration
> Serial Port 4 Configuration
> Serial Port 5 Configuration
Enable or Disable Serial
Port 1 (COMA)
-----
<->: Select Screen
↑ ↓: Select Item
EnterSelect
+/-: Change Opt.
F1:  General Help
F2:  Previous Values
F3:  Optimized Defaults
F4:  Save & Exit
ESC: Exit
Version 2.17.1255. Copyright (C) 2016 American Megatrends, Inc.
  
```

BIOS Menu 8: Serial Port n Configuration Menu

5.3.6.1 Serial Port n Configuration

Use the **Serial Port n Configuration** menu (**BIOS Menu 9**) to configure the serial port n.

```

Aptio Setup Utility - Copyright (C) 2016 American Megatrends, Inc.
  Advanced
Serial Port n Configuration
Serial Port                [Enabled]
Device Settings            IO=3F8h; IRQ=4
Transfer Mode              [RS232]
Enable or Disable Serial
Port (COM)
-----
<->: Select Screen
↑ ↓: Select Item
EnterSelect
+/-: Change Opt.
F1:  General Help
F2:  Previous Values
F3:  Optimized Defaults
F4:  Save & Exit
ESC: Exit
Version 2.17.1255. Copyright (C) 2016 American Megatrends, Inc.
  
```

BIOS Menu 9: Serial Port n Configuration Menu

5.3.6.1.1 Serial Port 1 Configuration

→ Serial Port n Configuration

Use the Serial Port n Configuration menu (BIOS Menu 7) to configure the serial port n.

→ Serial Port [Enabled]

Use the **Serial Port** option to enable or disable the serial port.

→ **Disabled** Disable the serial port

→ **Enabled** **DEFAULT** Enable the serial port

→ Transfer Mode [RS232]

Use the **Transfer Mode** option to select the serial port mode.

→ **RS232** **DEFAULT** Enables serial port RS-232 support.

→ **RS422** Enables serial port RS-422 support.

→ **RS485** Enables serial port RS-485 support.

5.3.6.1.2 Serial Port 2 Configuration

→ Serial Port n Configuration

Use the Serial Port n Configuration menu (BIOS Menu 7) to configure the serial port n.

→ Serial Port [Enabled]

Use the **Serial Port** option to enable or disable the serial port.

→ **Disabled** Disable the serial port

→ **Enabled** **DEFAULT** Enable the serial port

TANK-880-Q370**→ Transfer Mode [RS232]**

Use the **Transfer Mode** option to select the serial port mode.

- RS232 DEFAULT** Enables serial port RS-232 support.
- RS422** Enables serial port RS-422 support.
- RS485** Enables serial port RS-485 support.

5.3.6.1.3 Serial Port 3 Configuration**→ Serial Port n Configuration**

Use the Serial Port n Configuration menu (BIOS Menu 7) to configure the serial port n.

→ Serial Port [Enabled]

Use the **Serial Port** option to enable or disable the serial port.

- Disabled** Disable the serial port
- Enabled DEFAULT** Enable the serial port

→ Transfer Mode [RS232]

Use the **Transfer Mode** option to select the serial port mode.

- RS232 DEFAULT** Enables serial port RS-232 support.
- RS422** Enables serial port RS-422 support.
- RS485** Enables serial port RS-485 support.

5.3.6.1.4 Serial Port 4 Configuration**→ Serial Port n Configuration**

Use the Serial Port n Configuration menu (BIOS Menu 7) to configure the serial port n.

→ **Serial Port [Enabled]**

Use the **Serial Port** option to enable or disable the serial port.

- **Disabled** Disable the serial port
- **Enabled** **DEFAULT** Enable the serial port

5.3.6.1.5 Serial Port 5 Configuration

→ **Serial Port n Configuration**

Use the Serial Port n Configuration menu (BIOS Menu 7) to configure the serial port n.

→ **Serial Port [Enabled]**

Use the **Serial Port** option to enable or disable the serial port.

- **Disabled** Disable the serial port
- **Enabled** **DEFAULT** Enable the serial port

5.3.7 iWDD H/W Monitor

The iWDD H/W Monitor menu (**BIOS Menu 10**) shows the operating temperature, fan speeds and system voltages.

TANK-880-Q370

```

Aptio Setup Utility - Copyright (C) 2016 American Megatrends, Inc.
Advanced
PC Health Status
CPU Temperature           :+31°C
SYS Temperature1         :+29°C
SYS Temperature1         :+27°C
CPU_FAN1 Speed           :N/A
CPU_FAN2 Speed           :N/A

CPU_CORE1                 :+0.873 V
+5V                       :+5.052 V
+12V                      :+12.064 V
+DDR                      :+1.202 V
DC_IN_EC                  :+18.659
+3.3V                     :+3.266 V

> Smart Fan Mode Configuration

If CPU Temperature reach Tcc
Temperature(40~100),
Then reduce CPU Frequency.

-----
<=>: Select Screen
↑ ↓: Select Item
Enter>Select
+/-: Change Opt.
F1:  General Help
F2:  Previous Values
F3:  Optimized Defaults
F4:  Save & Exit
ESC: Exit

Version 2.17.1255. Copyright (C) 2016 American Megatrends, Inc.
  
```

BIOS Menu 10: F81866 H/W Monitor

→ PC Health Status

The following system parameters and values are shown. The system parameters that are monitored are:

- System Temperatures:
 - CPU Temperature
 - System Temperature
- Fan Speeds:
 - CPU_Fan1 Speed
- Voltages:
 - +VCCCORE
 - +V5S
 - +V12S
 - +VDDQ
 - MBATTERY_IN1_EC
 - SBATTERY_A_EC

➔ **Smart Fan Mode Configuration**

Use the Smart Fan Mode Configuration submenu (**BIOS Menu 11**) to configure the smart fan temperature and speed settings.

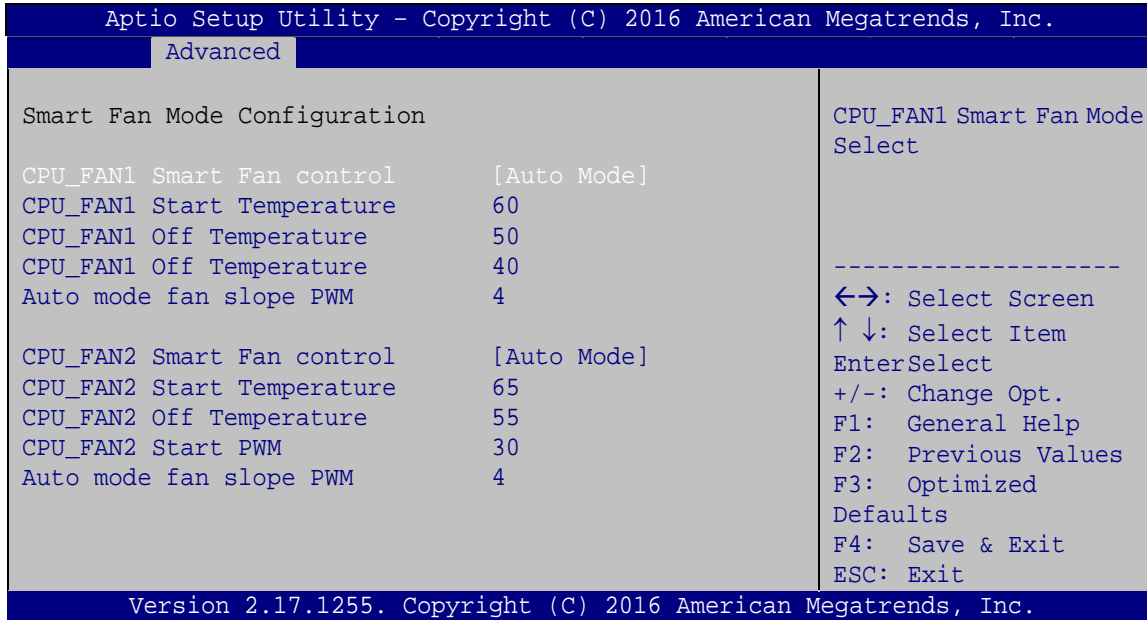

BIOS Menu 11: Smart Fan Mode Configuration

➔ **Smart Fan Mode Configuration**

Use the Smart Fan Mode Configuration submenu (BIOS Menu 16) to configure the smart fan temperature and speed settings.

➔ **Smart Fan control [Auto Mode]**

Use the **Smart Fan control** BIOS option to configure the CPU Smart Fan.

- ➔ **Manual Mode** The fan spins at the speed set in the manual setting
- ➔ **Auto Mode** **DEFAULT** The fan adjusts its speed using these settings:
 - CPU_FAN1 Start Temperature
 - CPU_FAN1 Off Temperature
 - CPU_FAN1 Start PWM

TANK-880-Q370

→ CPU_FAN1 Start/Off Temperature

Use the + or – key to change the **CPU_FAN1 Start/Off Temperature** value. Enter a decimal number between 1 and 100.

→ CPU_FAN1 start PWM

Use the + or – key to change the **CPU_FAN1 start PWM** value. Enter a decimal number between 1 and 100.

5.3.8 Serial Port Console Redirection

The Serial Port Console Redirection menu (**BIOS Menu 12**) allows the console redirection options to be configured. Console redirection allows users to maintain a system remotely by re-directing keyboard input and text output through the serial port.

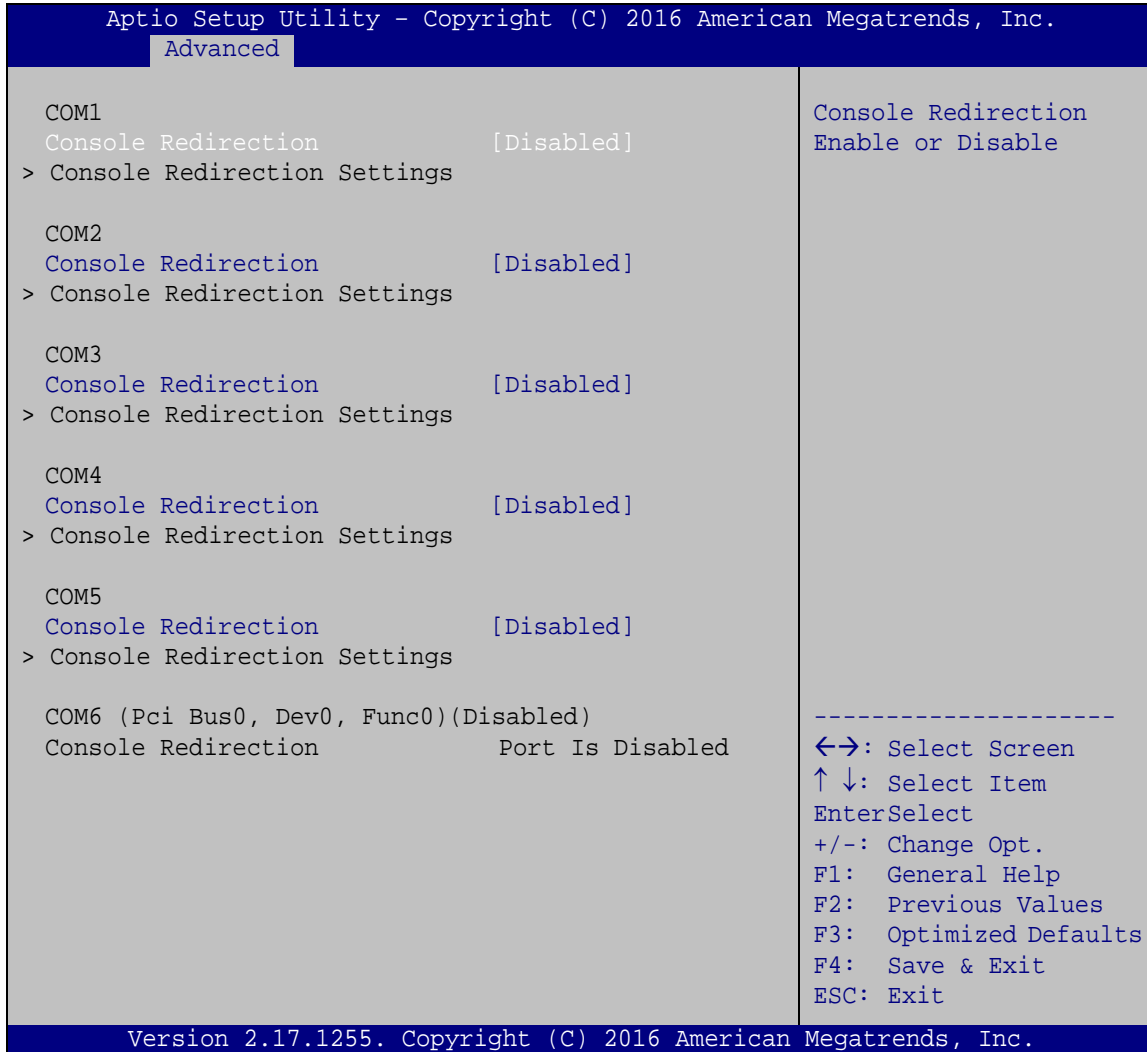

BIOS Menu 12: Serial Port Console Redirection

➔ **Console Redirection [Disabled]**

Use **Console Redirection** option to enable or disable the console redirection function.

- ➔ **Disabled** **DEFAULT** Disabled the console redirection function
- ➔ **Enabled** Enabled the console redirection function

TANK-880-Q370

5.3.9 USB Configuration

Use the **USB Configuration** menu (**BIOS Menu 13**) to read USB configuration information and configure the USB settings.

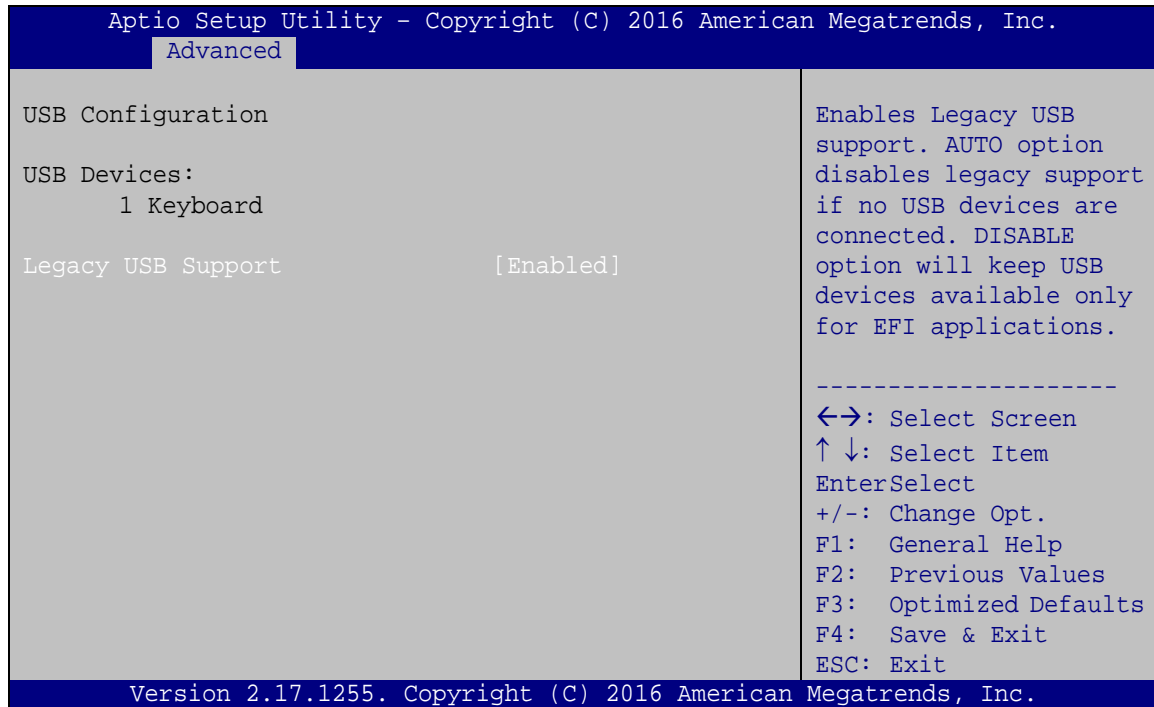

BIOS Menu 13: USB Configuration

➔ USB Devices

The **USB Devices** field lists the USB devices that are enabled on the system

➔ Legacy USB Support [Enabled]

Use the **Legacy USB Support** BIOS option to enable USB mouse and USB keyboard support. Normally if this option is not enabled, any attached USB mouse or USB keyboard does not become available until a USB compatible operating system is fully booted with all USB drivers loaded. When this option is enabled, any attached USB mouse or USB keyboard can control the system even when there is no USB driver loaded onto the system.

➔ **Enabled** **DEFAULT** Legacy USB support enabled

- ➔ **Disabled** Legacy USB support disabled
- ➔ **Auto** Legacy USB support disabled if no USB devices are connected

5.3.10 NVMe Configuration

Use the NVMe Configuration menu (**BIOS Menu 14**) to change and/or set the configuration of the NVMe devices installed in the system.

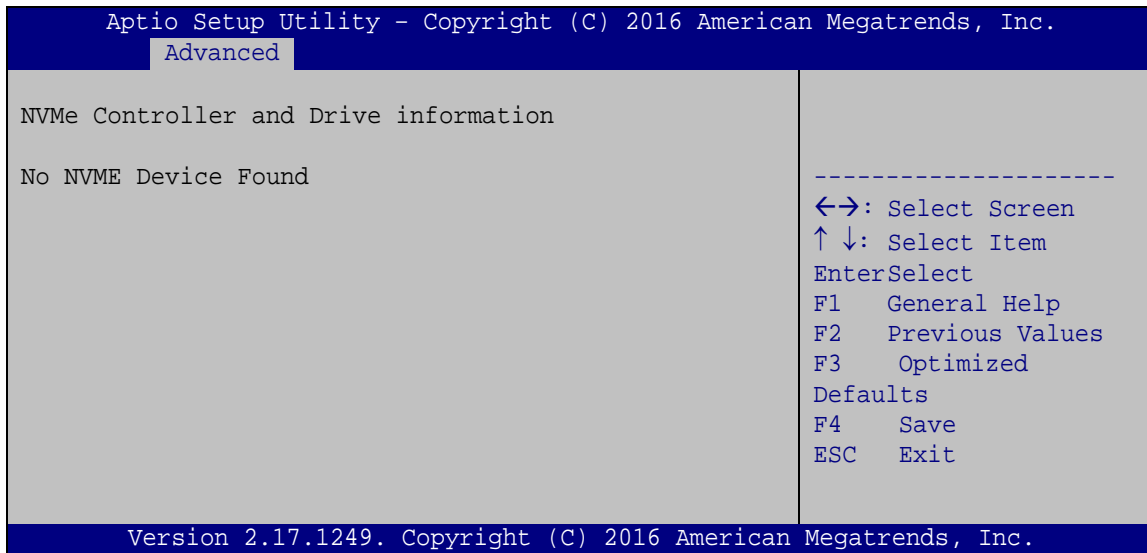

BIOS Menu 14: NVMe Configuration

TANK-880-Q370

5.3.11 iEi Feature

Use the **iEi Feature** menu (**BIOS Menu 15**) to configure the iEi features.

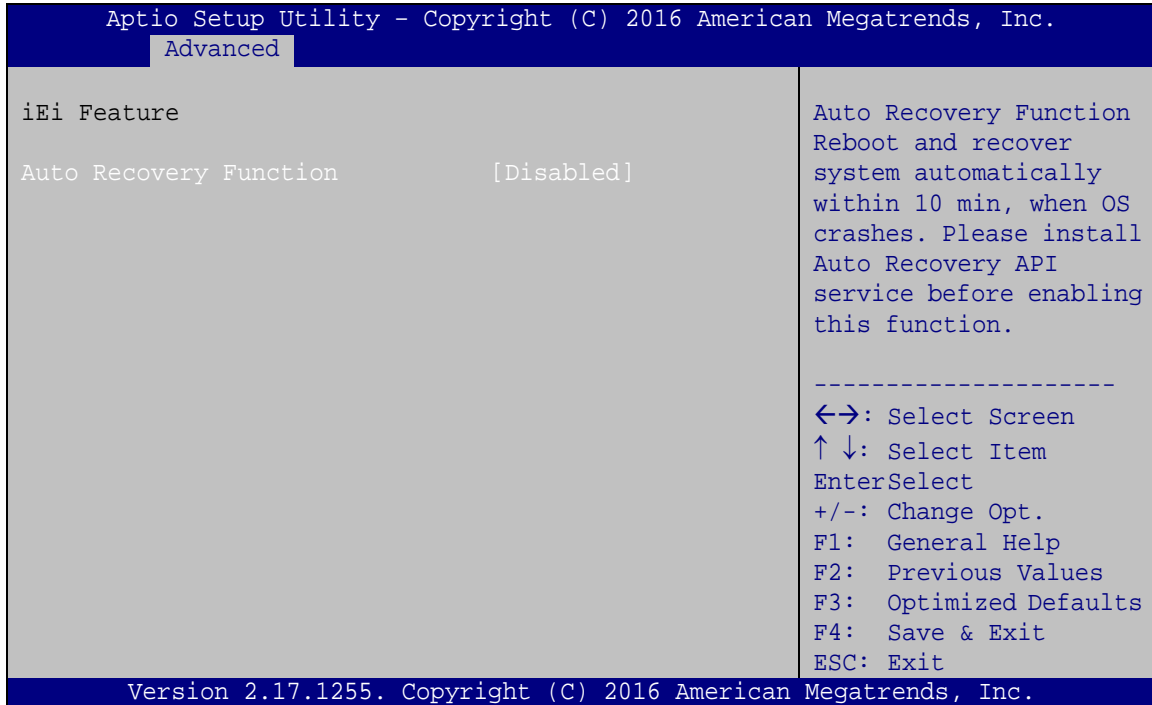

BIOS Menu 15: iEi Feature

➔ Auto Recovery Function [Disabled]

Use **Auto Recovery Function** option to enable or disable the auto recovery function.

- ➔ **Disabled** **DEFAULT** Disabled the auto recovery function
- ➔ **Enabled** Enabled the auto recovery function

5.4 Chipset

Use the **Chipset** menu (**BIOS Menu 16**) to access the PCH-IO and System Agent (SA) configuration menus.



WARNING!

Setting the wrong values for the Chipset BIOS selections in the Chipset BIOS menu may cause the system to malfunction.

```

Aptio Setup Utility - Copyright (C) 2016 American Megatrends, Inc.
  Chipset
> System Agent (SA) Configuration
> PCH-IO Configuration

PCH Parameters
-----
<->: Select Screen
↑ ↓: Select Item
Enter>Select
+/-: Change Opt.
F1:  General Help
F2:  Previous Values
F3:  Optimized Defaults
F4:  Save & Exit
ESC: Exit

Version 2.17.1255. Copyright (C) 2016 American Megatrends, Inc.
    
```

BIOS Menu 16: Chipset

TANK-880-Q370

5.4.1 System Agent (SA) Configuration

Use the **System Agent (SA) Configuration** menu (**BIOS Menu 17**) to configure the System Agent (SA) parameters.

```

Aptio Setup Utility - Copyright (C) 2016 American Megatrends, Inc.
Chipset
> Memory Configuration
> Graphics Configuration
> PEG Port Configuration
VT-d                               [Enabled]
Check to enable VT-d
function on MCH.
-----
-><: Select Screen
↑↓: Select Item
Enter: Select
+/-: Change Opt.
F1: General Help
F2: Previous Values
F3: Optimized Defaults
F4: Save & Exit
ESC: Exit
Version 2.17.1255. Copyright (C) 2016 American Megatrends, Inc.

```

BIOS Menu 17: System Agent (SA) Configuration

5.4.1.1 Memory Configuration

Use the **Memory Configuration** submenu (**BIOS Menu 18**) to view memory information.

```

Aptio Setup Utility - Copyright (C) 2016 American Megatrends, Inc.
Chipset
Memory Information
DIMM1                               Not Populated/ Disabled
DIMM2                               Populated&Enabled
Size                                8192 MB(DDR4)
Max TOLUD                            [3 GB]
-----
-><: Select Screen
↑↓: Select Item
Enter: Select
+/-: Change Opt.
F1: General Help
F2: Previous Values
F3: Optimized Defaults
F4: Save & Exit
ESC: Exit
Version 2.17.1255. Copyright (C) 2016 American Megatrends, Inc.

```

BIOS Menu 18: Memory Configuration

5.4.1.2 Graphics Configuration

Use the **Graphics Configuration (BIOS Menu 19)** menu to configure the video device connected to the system.

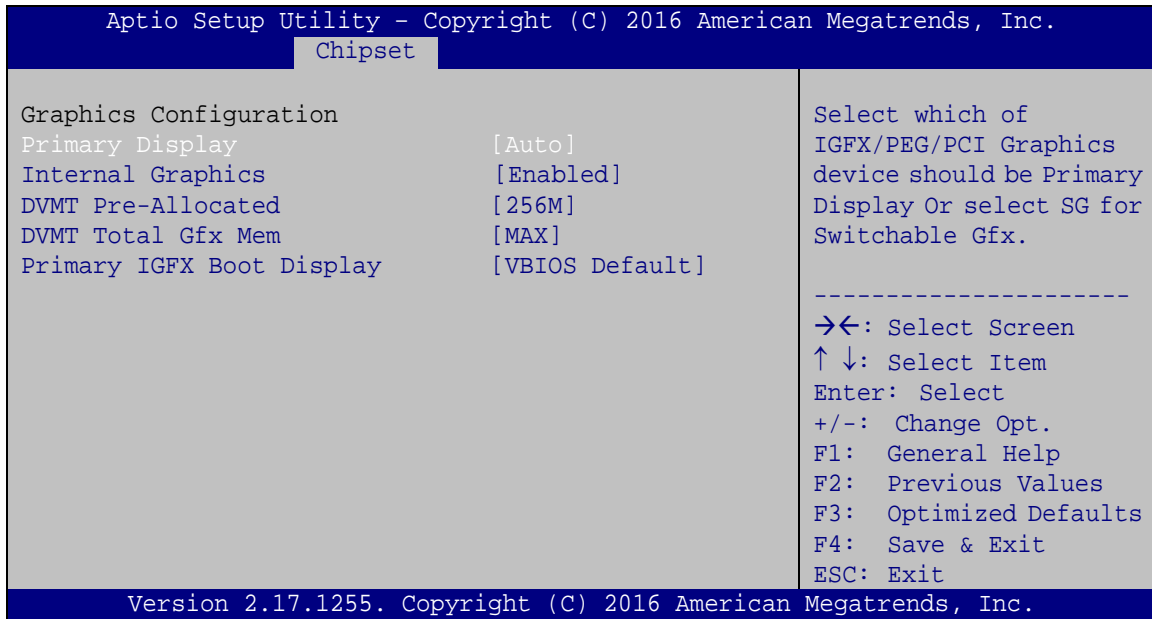

BIOS Menu 19: Graphics Configuration

→ Primary Display [Auto]

Use the **Primary Display** option to select the primary graphics controller the system uses.

The following options are available:

- Auto **Default**
- IGFX
- PEG
- PCI

→ DVMT Pre-Allocated [256M]

Use the **DVMT Pre-Allocated** option to set the amount of system memory allocated to the integrated graphics processor when the system boots. The system memory allocated can then only be used as graphics memory, and is no longer available to applications or the operating system. Configuration options are listed below:

- 32M

TANK-880-Q370

- 64M
- 128M
- 256M **Default**
- 512M

→ DVMT Total Gfx Mem [MAX]

Use the **DVMT Total Gfx Mem** option to select DVMT5.0 total graphic memory size used by the internal graphic device. The following options are available:

- 128M
- 256M
- MAX **Default**

→ Primary IGFX Boot Display [VBIOS Default]

Use the **Primary IGFX Boot Display** option to select the display device used by the system when it boots. Configuration options are listed below.

- VBIOS Default **DEFAULT**
- DP_HDMI1
- VGA1
- DP1

5.4.1.3 PEG Port Configuration

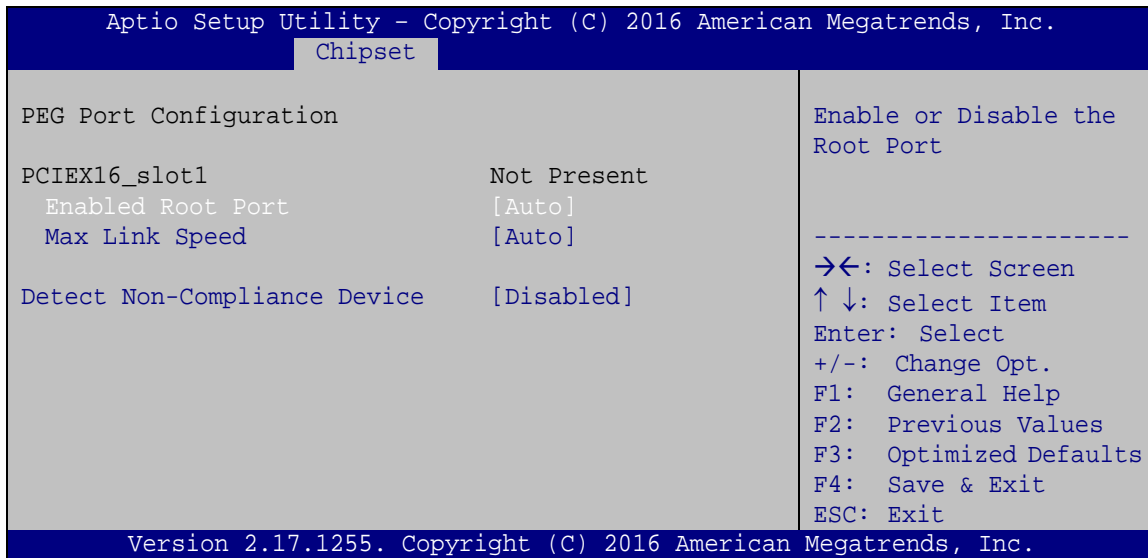

BIOS Menu 20: NB PCIe Configuration

→ Enable Root Port [Auto]

Use the **Enable Root Port** option to enable or disable the PCI Express (PEG) controller.

The following options are available:

- Disabled
- Enabled
- Auto **Default**

→ Max Link Speed [Auto]

Use the **Max Link Speed** option to configure the PEG port max speed. The following options are available:

- Auto **Default**
- Gen1
- Gen2
- Gen3

TANK-880-Q370

→ Detect Non-Compliance Device [Disabled]

Use the **Detect Non-Compliance Device** option to enable or disable detecting a non-compliance PCI Express device in the PEG. The following options are available:

- Disabled **Default**
- Enabled

5.4.2 PCH-IO Configuration

Use the **PCH-IO Configuration** menu (**BIOS Menu 21**) to configure the PCH parameters.

```

Aptio Setup Utility - Copyright (C) 2016 American Megatrends, Inc.
Chipset
PCH-IO Configuration
Auto Power Button Status      [Enabled(AT)]
Power Saving Function(EUP)    [Disabled]
USB Power SW1                  [+5VDUAL]
USB Power SW2                  [+5VDUAL]
> PCI Express Configuration
> SATA Configuration
> HD Audio Configuration

High Definition Audio
Controller.
-----
→←: Select Screen
↑↓: Select Item
Enter: Select
+/-: Change Opt.
F1: General Help
F2: Previous Values
F3: Optimized Defaults
F4: Save & Exit
ESC: Exit

Version 2.17.1255. Copyright (C) 2016 American Megatrends, Inc.

```

BIOS Menu 21: PCH-IO Configuration

→ Power Saving Function (ERP) [Disabled]

Use the **Power Saving Function (ERP)** BIOS option to enable or disable the power saving function.

- **Disabled** **DEFAULT** Power saving function is disabled.
- **Enabled** Power saving function is enabled. It will reduce power consumption when the system is off.

➔ **USB Power SW1 [+5V DUAL]**

Use the **USB Power SW1** BIOS option to configure the USB power source for the corresponding USB connectors.

- ➔ **+5V** Sets the USB power source to +5V
- ➔ **+5VDUAL** **DEFAULT** Sets the USB power source to +5V dual

5.4.2.1 PCI Express Configuration

Use the **PCI Express Configuration** menu (**BIOS Menu 22**) to select the support type of the PCIe Mini slot.

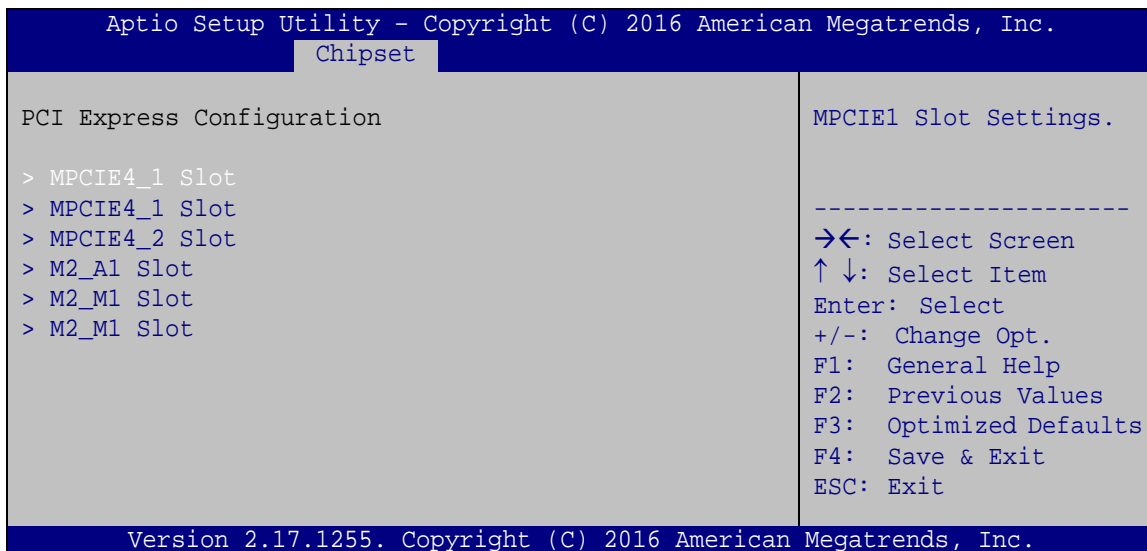

BIOS Menu 22: PCI Express Configuration

The **MPCIE1 Slot**, **MINI-PCIE1 Slot** and **MPCIE2 Slot** submenus all contain the following options:

➔ **PCI Express Root [Enabled]**

Use the **PCI Express Root** option to enable or disable the PCI Express (PEG) controller.

The following options are available:

- Disabled
- Enabled **Default**

TANK-880-Q370

→ PCIe Speed

Use PCIe Speed option to select the speed type of the PCIe Mini slot. The following options are available:

- Auto **Default**
- Gen1
- Gen2
- Gen3

→ Detect Non-Compliance Device [Disabled]

Use the **Detect Non-Compliance Device** option to enable or disable the “detect no-compliance PCIe device” function.

- **Disabled** **DEFAULT** Detect no-compliance PCIe device function is disabled
- **Enabled** Detect no-compliance PCIe device function is enabled. If will take more time at POST if it is enabled.

TANK-880-Q370

→ Hot Plug [Disabled]

Use the **Hot Plug** option to enable or disable the SATA device hot plug.

- **Disabled** **DEFAULT** Disables the SATA device hot plug.
- **Enabled** Enables the SATA device hot plug

5.4.2.3 HD Audio Configuration

Use the **HD Audio Configuration** submenu (**BIOS Menu 24**) to configure the High Definition Audio codec.

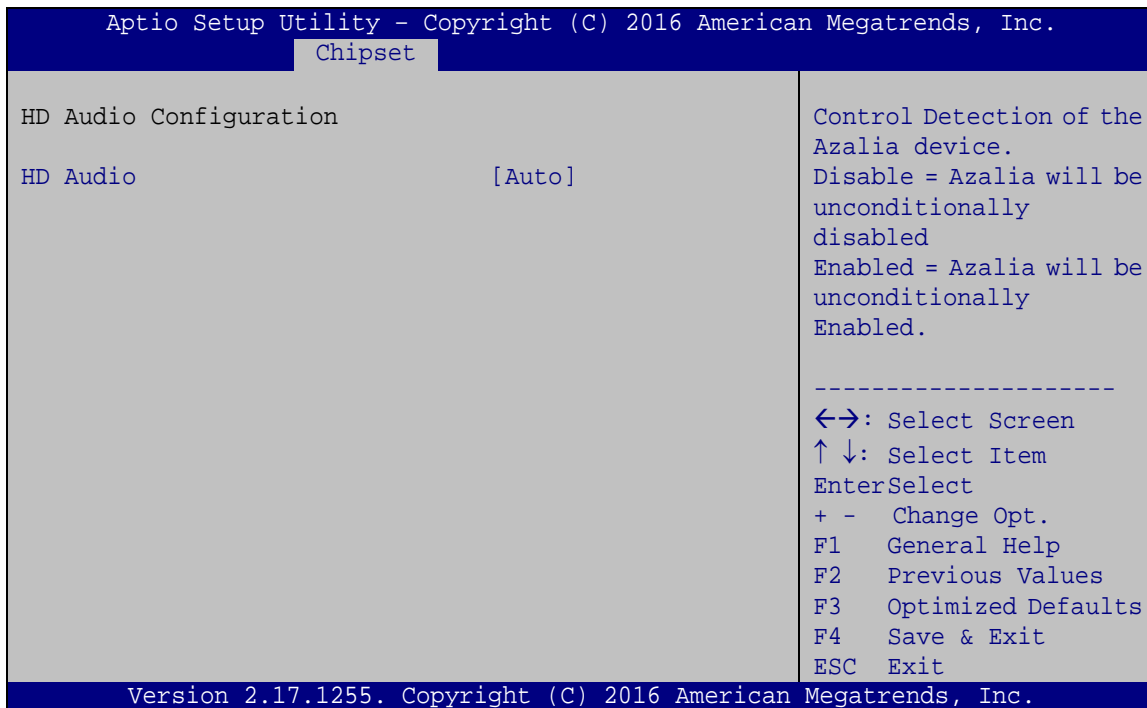

BIOS Menu 24: HD Audio Configuration

→ HD Audio [Enabled]

Use the **HD Audio** option to enable or disable the High Definition Audio controller.

- **Disabled** The onboard High Definition Audio controller is disabled
- **Enabled** **DEFAULT** The onboard High Definition Audio controller automatically detected and enabled

5.5 Security

Use the **Security** menu (**BIOS Menu 25**) to set system and user passwords.

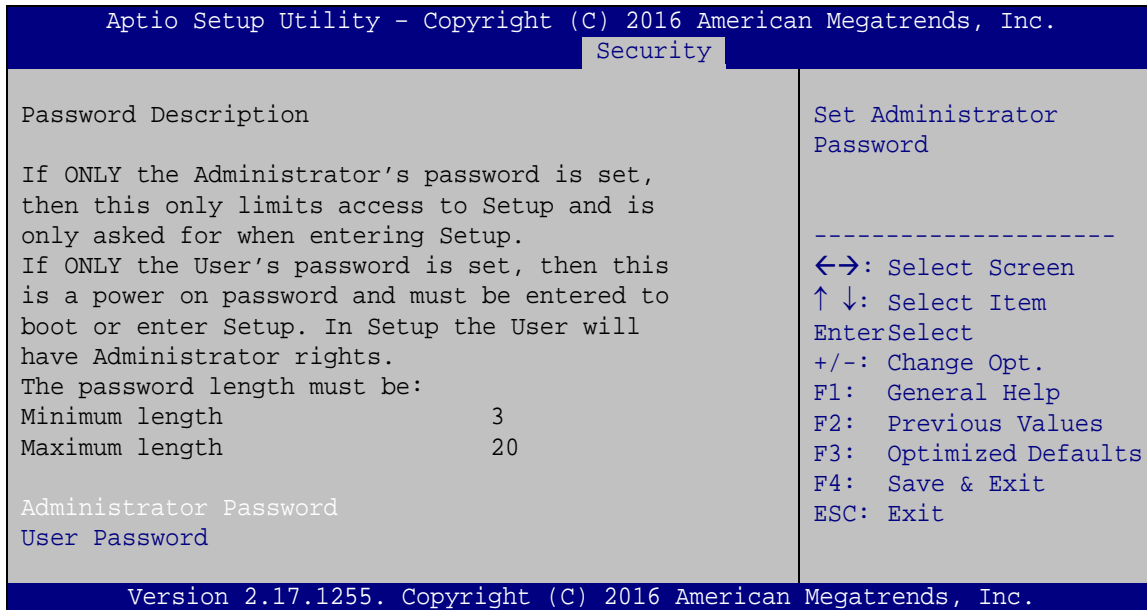

BIOS Menu 25: Security

➔ Administrator Password

Use the **Administrator Password** to set or change an administrator password.

➔ User Password

Use the **User Password** to set or change a user password.

TANK-880-Q370

5.6 Boot

Use the **Boot** menu (**BIOS Menu 26**) to configure system boot options.

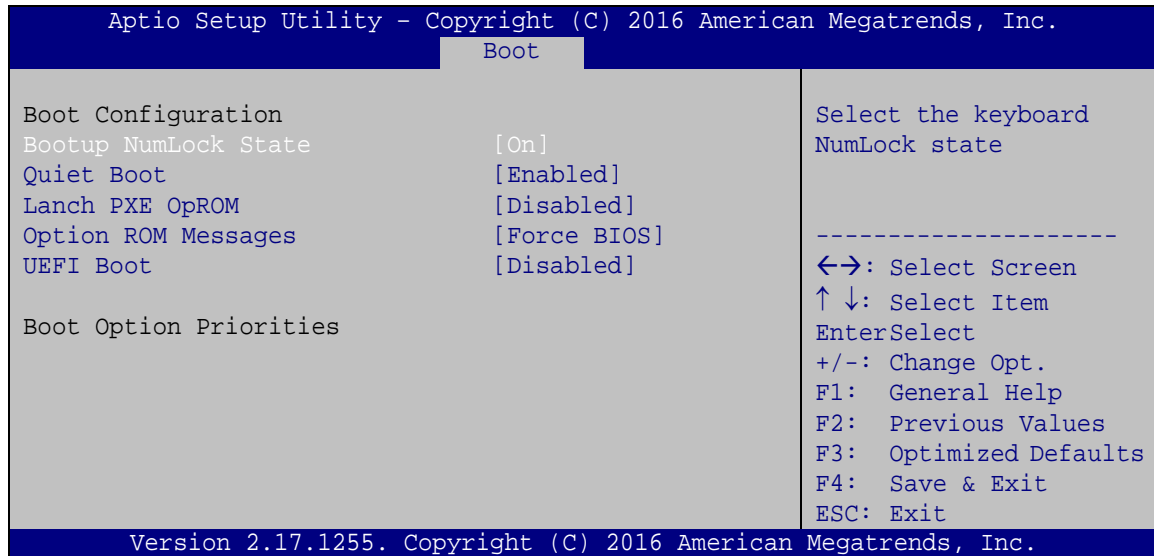

BIOS Menu 26: Boot

→ Bootup NumLock State [On]

Use the **Bootup NumLock State** BIOS option to specify if the number lock setting must be modified during boot up.

- **On** **DEFAULT** Allows the Number Lock on the keyboard to be enabled automatically when the computer system boots up. This allows the immediate use of the 10-key numeric keypad located on the right side of the keyboard. To confirm this, the Number Lock LED light on the keyboard is lit.

- **Off** Does not enable the keyboard Number Lock automatically. To use the 10-keys on the keyboard, press the Number Lock key located on the upper left-hand corner of the 10-key pad. The Number Lock LED on the keyboard lights up when the Number Lock is engaged.

→ Quiet Boot [Enabled]

Use the **Quiet Boot** BIOS option to select the screen display when the system boots.

- **Disabled** Normal POST messages displayed
- **Enabled** **DEFAULT** OEM Logo displayed instead of POST messages

→ Launch PXE OpROM [Disabled]

Use the **Launch PXE OpROM** option to enable or disable boot option for legacy network devices.

- **Disabled** **DEFAULT** Ignore all PXE Option ROMs
- **Enabled** Load PXE Option ROMs.

→ Option ROM Messages [Force BIOS]

Use the **Option ROM Messages** option to set the Option ROM display mode.

- **Force BIOS** **DEFAULT** Sets display mode to force BIOS.
- **Keep Current** Sets display mode to current.

→ UEFI Boot [Disabled]

Use the **UEFI Boot** option to enable or disable to boot from the UEFI devices.

- **Enabled** Boot from UEFI devices is enabled.
- **Disabled** **DEFAULT** Boot from UEFI devices is disabled.

TANK-880-Q370

5.7 Save & Exit

Use the **Save & Exit** menu (**BIOS Menu 27**) to load default BIOS values, optimal failsafe values and to save configuration changes.

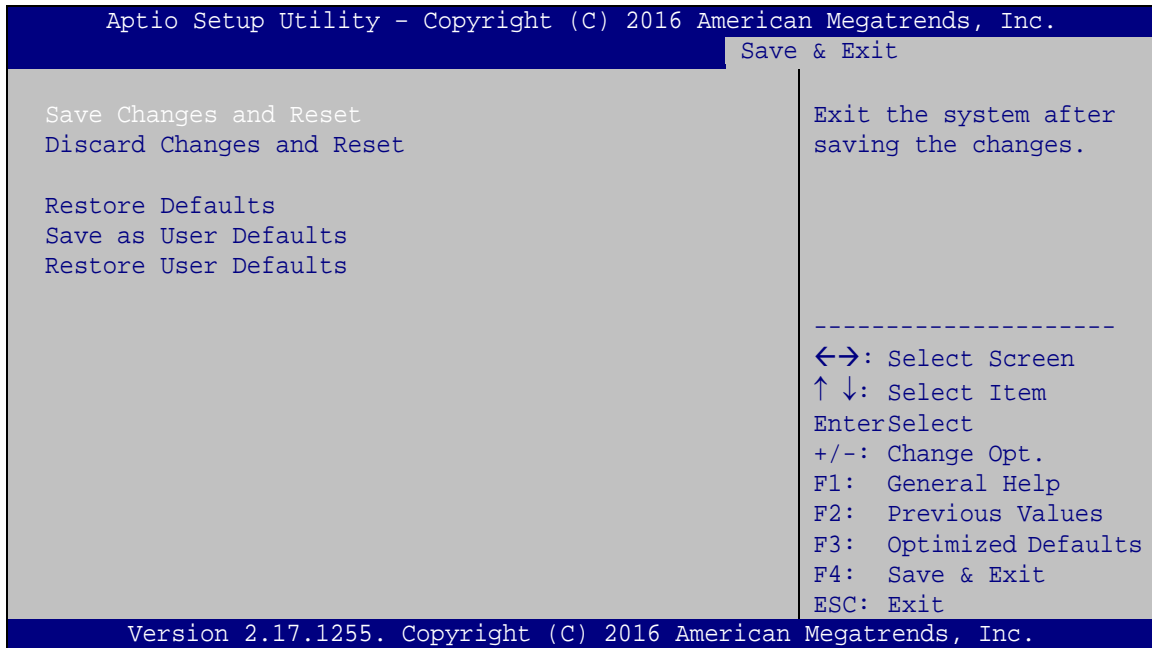
**BIOS Menu 27:Exit****→ Save Changes and Reset**

Use the **Save Changes and Reset** option to save the changes made to the BIOS options and reset the system.

→ Discard Changes and Reset

Use the **Discard Changes and Reset** option to exit the system without saving the changes made to the BIOS configuration setup program.

→ Restore Defaults

Use the **Restore Defaults** option to load the optimal default values for each of the parameters on the Setup menus. **F3 key can be used for this operation.**

➔ **Save as User Defaults**

Use the **Save as User Defaults** option to save the changes done so far as user defaults.

➔ **Restore User Defaults**

Use the **Restore User Defaults** option to restore the user defaults to all the setup options.

5.8 Server Mgmt

Use the **Server Mgmt** menu (**BIOS Menu 28**) to access the server management menus.

```

Aptio Setup Utility - Copyright (C) 2016 American Megatrends, Inc.
                                     Server Mgmt
BMC Self Test Status                 FAILED
BMC Firmware Revision                Unknown
> System Event Log
> BMC network configuration

-----
<=>: Select Screen
↑ ↓: Select Item
Enter>Select
+ - Change Opt.
F1 General Help
F2 Previous Values
F3 Optimized Defaults
F4 Save & Exit
ESC Exit

Version 2.17.1255. Copyright (C) 2016 American Megatrends, Inc.
    
```

BIOS Menu 28: Server Mgmt

TANK-880-Q370

5.8.1.1 System Event Log

Use the **System Event Log** menu (**BIOS Menu 29**) to configure the event log.

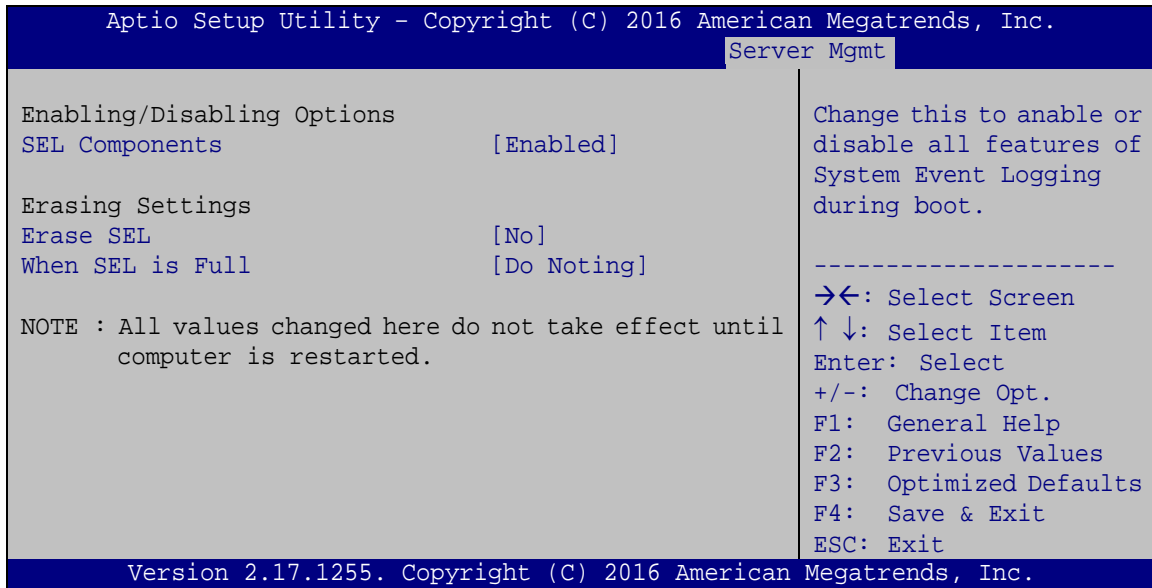
**BIOS Menu 29: System Event Log**→ **SEL Components [Enabled]**

Use the **SEL Components** option to enable or disable all features of system event logging during boot.

→ **Disabled** Disables all features of system event logging during boot.

→ **Enabled** **DEFAULT** Enables all features of system event logging during boot.

→ **Erase SEL [No]**

Use **Erase SEL** option to select options for erasing SEL. The following options are available:

- No **Default**
- Yes, On next reset
- Yes, On every reset

➔ **When SEL is Full [Do Nothing]**

Use **When SEL is FULL** option to select options for reactions to a full SEL. The following options are available:

- Do Nothing **Default**
- Erase Immediately

5.8.1.2 BMC network configuration

Use the **BMC network configuration** menu (**BIOS Menu 30**) to configure BMC network parameters.

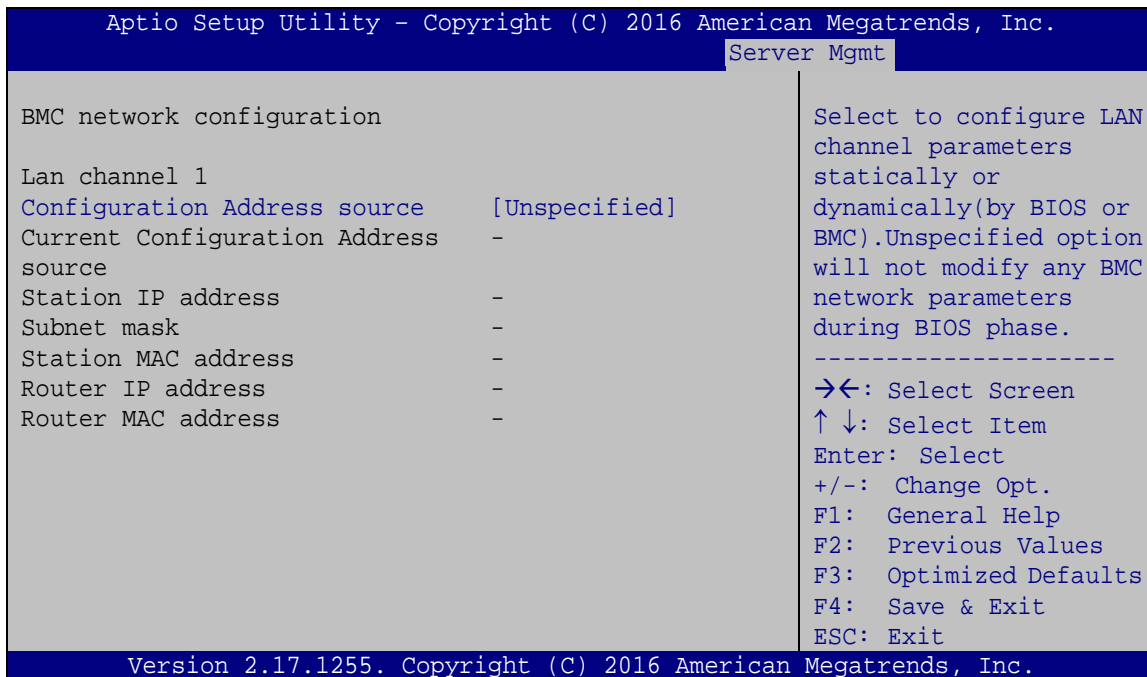

BIOS Menu 30: PCH Azalia Configuration Menu

➔ **Configuration Address source [Unspecified]**

Use **Configuration Address source** option to configure LAN channel parameters. The following options are available:

- Unspecified **Default**
- Static
- DynamicBmcDhcp
- DynamicBmcNonDhcp

Appendix

A

Regulatory Compliance

DECLARATION OF CONFORMITY



This equipment is in conformity with the following EU directives:

- EMC Directive (2004/108/EC, 2014/30/EU)
- Low-Voltage Directive (2006/95/EC, 2014/35/EU)
- RoHS II Directive (2011/65/EU, 2015/863/EU)

If the user modifies and/or install other devices in the equipment, the CE conformity declaration may no longer apply.

If this equipment has telecommunications functionality, it also complies with the requirements of the Radio Equipment Directive 2014/53/EU.

English

IEI Integration Corp declares that this equipment is in compliance with the essential requirements and other relevant provisions of Directive 2014/53/EU.

Български [Bulgarian]

IEI Integration Corp. декларира, че този оборудване е в съответствие със съществените изисквания и другите приложими правила на Директива 2014/53/EU.

Česky [Czech]

IEI Integration Corp tímto prohlašuje, že tento zařizení je ve shodě se základními požadavky a dalšími příslušnými ustanoveními směrnice 2014/53/EU.

Dansk [Danish]

IEI Integration Corp erklærer herved, at følgende udstyr overholder de væsentlige krav og øvrige relevante krav i direktiv 2014/53/EU.

Deutsch [German]

IEI Integration Corp, erklärt dieses Gerät entspricht den grundlegenden Anforderungen und den weiteren entsprechenden Vorgaben der Richtlinie 2014/53/EU.

TANK-880-Q370

Eesti [Estonian]

IEI Integration Corp deklareerib seadme seadme vastavust direktiivi 2014/53/EÜ põhinõuetele ja nimetatud direktiivist tulenevatele teistele asjakohastele sätetele.

Español [Spanish]

IEI Integration Corp declara que el equipo cumple con los requisitos esenciales y cualesquiera otras disposiciones aplicables o exigibles de la Directiva 2014/53/EU.

Ελληνική [Greek]

IEI Integration Corp ΔΗΛΩΝΕΙ ΟΤΙ ΕΞΟΠΛΙΣΜΟΣ ΣΥΜΜΟΡΦΩΝΕΤΑΙ ΠΡΟΣ ΤΙΣ ΟΥΣΙΩΔΕΙΣ ΑΠΑΙΤΗΣΕΙΣ ΚΑΙ ΤΙΣ ΛΟΙΠΕΣ ΣΧΕΤΙΚΕΣ ΔΙΑΤΑΞΕΙΣ ΤΗΣ ΟΔΗΓΙΑΣ 2014/53/EU.

Français [French]

IEI Integration Corp déclare que l'appareil est conforme aux exigences essentielles et aux autres dispositions pertinentes de la directive 2014/53/EU.

Italiano [Italian]

IEI Integration Corp dichiara che questo apparecchio è conforme ai requisiti essenziali ed alle altre disposizioni pertinenti stabilite dalla direttiva 2014/53/EU.

Latviski [Latvian]

IEI Integration Corp deklarē, ka iekārta atbilst būtiskajām prasībām un citiem ar to saistītajiem noteikumiem Direktīvas 2014/53/EU.

Lietuvių [Lithuanian]

IEI Integration Corp deklaruoja, kad šis įranga atitinka esminius reikalavimus ir kitas 2014/53/EU Direktyvos nuostatas.

Nederlands [Dutch]

IEI Integration Corp dat het toestel toestel in overeenstemming is met de essentiële eisen en de andere relevante bepalingen van richtlijn 2014/53/EU.

Malti [Maltese]

IEI Integration Corp jiddikjara li dan prodott jikkonforma mal-ħtiġijiet essenzjali u ma provvedimenti oħrajn relevanti li hemm fid-Dirrettiva 2014/53/EU.

Magyar [Hungarian]

IEI Integration Corp nyilatkozom, hogy a berendezés megfelel a vonatkozó alapvető követelményeknek és az 2014/53/EU irányelv egyéb előírásainak.

Polski [Polish]

IEI Integration Corp oświadcza, że wyrobu jest zgodny z zasadniczymi wymogami oraz pozostałymi stosownymi postanowieniami Dyrektywy 2014/53/EU.

Português [Portuguese]

IEI Integration Corp declara que este equipamento está conforme com os requisitos essenciais e outras disposições da Directiva 2014/53/EU.

Româna [Romanian]

IEI Integration Corp declară că acest echipament este în conformitate cu cerințele esențiale și cu celelalte prevederi relevante ale Directivei 2014/53/EU.

Slovensko [Slovenian]

IEI Integration Corp izjavlja, da je ta opreme v skladu z bistvenimi zahtevami in ostalimi relevantnimi določili direktive 2014/53/EU.

Slovensky [Slovak]

IEI Integration Corp týmto vyhlasuje, že zariadenia spĺňa základné požiadavky a všetky príslušné ustanovenia Smernice 2014/53/EU.

Suomi [Finnish]

IEI Integration Corp vakuuttaa täten että laitteet on direktiivin 2014/53/EU oleellisten vaatimusten ja sitä koskevien direktiivin muiden ehtojen mukainen.

Svenska [Swedish]

IEI Integration Corp förklarar att denna utrustningstyp står i överensstämmelse med de väsentliga egenskapskrav och övriga relevanta bestämmelser som framgår av direktiv 2014/53/EU.



FCC WARNING

This equipment complies with Part 15 of the FCC Rules. Operation is subject to the following two conditions:

- This device may not cause harmful interference, and
- This device must accept any interference received, including interference that may cause undesired operation.

This equipment has been tested and found to comply with the limits for a Class A digital device, pursuant to part 15 of the FCC Rules. These limits are designed to provide reasonable protection against harmful interference when the equipment is operated in a commercial environment. This equipment generates, uses, and can radiate radio frequency energy and, if not installed and used in accordance with the instruction manual, may cause harmful interference to radio communications. Operation of this equipment in a residential area is likely to cause harmful interference in which case the user will be required to correct the interference at his own expense.

Federal Communication Commission Interference Statement

This equipment has been assembled with components that comply with the limits for a Class B digital device, pursuant to Part 15 of the FCC Rules. These limits are designed to provide reasonable protection against harmful interference in a residential installation. This equipment generates, uses and can radiate radio frequency energy and, if not installed and used in accordance with the instructions, may cause harmful interference to radio communications. However, there is no guarantee that interference will not occur in a particular installation. If this equipment does cause harmful interference to radio or television reception, which can be determined by turning the equipment off and on, the user is encouraged to try to correct the interference by one of the following measures:

- Reorient or relocate the receiving antenna.
- Increase the separation between the equipment and receiver.
- Connect the equipment into an outlet on a circuit different from that to which the receiver is connected.
- Consult the dealer or an experienced radio/TV technician for help.

Appendix

B

BIOS Options

TANK-880-Q370

Below is a list of BIOS configuration options in the BIOS chapter.

<input type="checkbox"/>	System Date [xx/xx/xx]	48
<input type="checkbox"/>	System Time [xx:xx:xx]	48
<input type="checkbox"/>	EIST [Enabled]	50
<input type="checkbox"/>	Hyper-threading [Enabled]	51
<input type="checkbox"/>	Active Processor Cores [All]	51
<input type="checkbox"/>	Intel Virtualization Technology [Disabled]	51
<input type="checkbox"/>	EIST [Enabled]	51
<input type="checkbox"/>	C states [Disabled]	52
<input type="checkbox"/>	Intel TXT(LT) Support [Disabled]	52
<input type="checkbox"/>	AMT BIOS Features [Enabled]	53
<input type="checkbox"/>	Unconfigure ME [Disabled]	53
<input type="checkbox"/>	Security Device Support [Disable]	54
<input type="checkbox"/>	ACPI Sleep State [S3 (Suspend to RAM)]	55
<input type="checkbox"/>	Wake System with Fixed Time [Disabled]	56
<input type="checkbox"/>	Serial Port n Configuration	58
<input type="checkbox"/>	Serial Port [Enabled]	58
<input type="checkbox"/>	Serial Port n Configuration	58
<input type="checkbox"/>	Serial Port [Enabled]	58
<input type="checkbox"/>	Serial Port n Configuration	59
<input type="checkbox"/>	Serial Port [Enabled]	59
<input type="checkbox"/>	Serial Port n Configuration	59
<input type="checkbox"/>	Serial Port [Enabled]	60
<input type="checkbox"/>	Serial Port n Configuration	60
<input type="checkbox"/>	Serial Port [Enabled]	60
<input type="checkbox"/>	PC Health Status	61
<input type="checkbox"/>	Smart Fan control [Auto Mode]	62
<input type="checkbox"/>	CPU_FAN1 Start/Off Temperature	63
<input type="checkbox"/>	CPU_FAN1 start PWM	63
<input type="checkbox"/>	Console Redirection [Disabled]	64
<input type="checkbox"/>	USB Devices	65
<input type="checkbox"/>	Legacy USB Support [Enabled]	65
<input type="checkbox"/>	Auto Recovery Function [Disabled]	67
<input type="checkbox"/>	Primary Display [Auto]	70

<input type="checkbox"/>	DVMT Pre-Allocated [256M]	70
<input type="checkbox"/>	DVMT Total Gfx Mem [MAX].....	71
<input type="checkbox"/>	Primary IGFX Boot Display [VBIOS Default]	71
<input type="checkbox"/>	Enable Root Port [Auto]	72
<input type="checkbox"/>	Max Link Speed [Auto]	72
<input type="checkbox"/>	Detect Non-Compliance Device [Disabled]	73
<input type="checkbox"/>	Power Saving Function (ERP) [Disabled].....	73
<input type="checkbox"/>	USB Power SW1 [+5V DUAL].....	74
<input type="checkbox"/>	PCI Express Root [Enabled]	74
<input type="checkbox"/>	PCIe Speed	75
<input type="checkbox"/>	Detect Non-Compliance Device [Disabled]	75
<input type="checkbox"/>	SATA Mode Selection [AHCI].....	76
<input type="checkbox"/>	Hot Plug [Disabled].....	77
<input type="checkbox"/>	HD Audio [Enabled]	77
<input type="checkbox"/>	Administrator Password	78
<input type="checkbox"/>	User Password	78
<input type="checkbox"/>	Bootup NumLock State [On].....	79
<input type="checkbox"/>	Quiet Boot [Enabled]	80
<input type="checkbox"/>	Launch PXE OpROM [Disabled].....	80
<input type="checkbox"/>	Option ROM Messages [Force BIOS].....	80
<input type="checkbox"/>	UEFI Boot [Disabled]	80
<input type="checkbox"/>	Save Changes and Reset	81
<input type="checkbox"/>	Discard Changes and Reset	81
<input type="checkbox"/>	Restore Defaults	81
<input type="checkbox"/>	Save as User Defaults	82
<input type="checkbox"/>	Restore User Defaults	82
<input type="checkbox"/>	SEL Components [Enabled].....	83
<input type="checkbox"/>	Erase SEL [No].....	83
<input type="checkbox"/>	When SEL is Full [Do Nothing].....	84
<input type="checkbox"/>	Configuration Address source [Unspecified]	84

Appendix

C

Terminology

AC '97	Audio Codec 97 (AC'97) refers to a codec standard developed by Intel® in 1997.
ACPI	Advanced Configuration and Power Interface (ACPI) is an OS-directed configuration, power management, and thermal management interface.
AHCI	Advanced Host Controller Interface (AHCI) is a SATA Host controller register-level interface.
ATA	The Advanced Technology Attachment (ATA) interface connects storage devices including hard disks and CD-ROM drives to a computer.
ARMD	An ATAPI Removable Media Device (ARMD) is any ATAPI device that supports removable media, besides CD and DVD drives.
ASKIR	Amplitude Shift Keyed Infrared (ASKIR) is a form of modulation that represents a digital signal by varying the amplitude (“volume”) of the signal. A low amplitude signal represents a binary 0, while a high amplitude signal represents a binary 1.
BIOS	The Basic Input/Output System (BIOS) is firmware that is first run when the computer is turned on and can be configured by the end user
CODEC	The Compressor-Decompressor (CODEC) encodes and decodes digital audio data on the system.
CompactFlash®	CompactFlash® is a solid-state storage device. CompactFlash® devices use flash memory in a standard size enclosure. Type II is thicker than Type I, but a Type II slot can support both types.
CMOS	Complimentary metal-oxide-conductor is an integrated circuit used in chips like static RAM and microprocessors.
COM	COM refers to serial ports. Serial ports offer serial communication to expansion devices. The serial port on a personal computer is usually a male D-sub 9 connector.
DAC	The Digital-to-Analog Converter (DAC) converts digital signals to analog signals.
DDR	Double Data Rate refers to a data bus transferring data on both the rising and falling edges of the clock signal.

TANK-880-Q370

DMA	Direct Memory Access (DMA) enables some peripheral devices to bypass the system processor and communicate directly with the system memory.
DIMM	Dual Inline Memory Modules are a type of RAM that offer a 64-bit data bus and have separate electrical contacts on each side of the module.
DIO	The digital inputs and digital outputs are general control signals that control the on/off circuit of external devices or TTL devices. Data can be read or written to the selected address to enable the DIO functions.
EHCI	The Enhanced Host Controller Interface (EHCI) specification is a register-level interface description for USB 2.0 Host Controllers.
EIDE	Enhanced IDE (EIDE) is a newer IDE interface standard that has data transfer rates between 4.0 MBps and 16.6 MBps.
EIST	Enhanced Intel® SpeedStep Technology (EIST) allows users to modify the power consumption levels and processor performance through application software. The application software changes the bus-to-core frequency ratio and the processor core voltage.
FSB	The Front Side Bus (FSB) is the bi-directional communication channel between the processor and the Northbridge chipset.
GbE	Gigabit Ethernet (GbE) is an Ethernet version that transfers data at 1.0 Gbps and complies with the IEEE 802.3-2005 standard.
GPIO	General purpose input
HDD	Hard disk drive (HDD) is a type of magnetic, non-volatile computer storage device that stores digitally encoded data.
ICH	The Input/Output Control Hub (ICH) is an Intel® Southbridge chipset.
IrDA	Infrared Data Association (IrDA) specify infrared data transmission protocols used to enable electronic devices to wirelessly communicate with each other.
L1 Cache	The Level 1 Cache (L1 Cache) is a small memory cache built into the system processor.
L2 Cache	The Level 2 Cache (L2 Cache) is an external processor memory cache.

LCD	Liquid crystal display (LCD) is a flat, low-power display device that consists of two polarizing plates with a liquid crystal panel in between.
LVDS	Low-voltage differential signaling (LVDS) is a dual-wire, high-speed differential electrical signaling system commonly used to connect LCD displays to a computer.
POST	The Power-on Self Test (POST) is the pre-boot actions the system performs when the system is turned-on.
RAM	Random Access Memory (RAM) is volatile memory that loses data when power is lost. RAM has very fast data transfer rates compared to other storage like hard drives.
SATA	Serial ATA (SATA) is a serial communications bus designed for data transfers between storage devices and the computer chipsets. The SATA bus has transfer speeds up to 1.5 Gbps and the SATA II bus has data transfer speeds of up to 3.0 Gbps.
S.M.A.R.T	Self Monitoring Analysis and Reporting Technology (S.M.A.R.T) refers to automatic status checking technology implemented on hard disk drives.
UART	Universal Asynchronous Receiver-transmitter (UART) is responsible for asynchronous communications on the system and manages the system's serial communication (COM) ports.
UHCI	The Universal Host Controller Interface (UHCI) specification is a register-level interface description for USB 1.1 Host Controllers.
USB	The Universal Serial Bus (USB) is an external bus standard for interfacing devices. USB 1.1 supports 12Mbps data transfer rates and USB 2.0 supports 480Mbps data transfer rates.
VGA	The Video Graphics Array (VGA) is a graphics display system developed by IBM.

Appendix

D

Safety Precautions

D.1 Safety Precautions



WARNING:

The precautions outlined in this appendix should be strictly followed. Failure to follow these precautions may result in permanent damage to the TANK-880-Q370 Series.

Please follow the safety precautions outlined in the sections that follow:

D.1.1 General Safety Precautions

Please ensure the following safety precautions are adhered to at all times.

- ***Make sure the power is turned off and the power cord is disconnected*** when moving, installing or modifying the system.
- ***Do not apply voltage levels that exceed the specified voltage range.*** Doing so may cause fire and/or an electrical shock.
- ***Electric shocks can occur*** if opened while still powered on.
- ***Do not drop or insert any objects*** into the ventilation openings.
- ***If considerable amounts of dust, water, or fluids enter the system***, turn off the power supply immediately, unplug the power cord, and contact the system vendor.
- **DO NOT:**
 - Drop the system against a hard surface.
 - In a site where the ambient temperature exceeds the rated temperature

TANK-880-Q370

D.1.2 Anti-static Precautions



WARNING:

Failure to take ESD precautions during the installation of the TANK-880-Q370 Series may result in permanent damage to the TANK-880-Q370 Series and severe injury to the user.

Electrostatic discharge (ESD) can cause serious damage to electronic components, including the TANK-880-Q370 Series. Dry climates are especially susceptible to ESD. It is therefore critical that whenever the TANK-880-Q370 Series is opened and any of the electrical components are handled, the following anti-static precautions are strictly adhered to.

- ***Wear an anti-static wristband:*** Wearing a simple anti-static wristband can help to prevent ESD from damaging any electrical component.
- ***Self-grounding:*** Before handling any electrical component, touch any grounded conducting material. During the time the electrical component is handled, frequently touch any conducting materials that are connected to the ground.
- ***Use an anti-static pad:*** When configuring or working with an electrical component, place it on an anti-static pad. This reduces the possibility of ESD damage.
- ***Only handle the edges of the electrical component:*** When handling the electrical component, hold the electrical component by its edges.

D.1.3 Product Disposal

**CAUTION:**

Risk of explosion if battery is replaced by and incorrect type. Only certified engineers should replace the on-board battery.

Dispose of used batteries according to instructions and local regulations.

- Outside the European Union - If you wish to dispose of used electrical and electronic products outside the European Union, please contact your local authority so as to comply with the correct disposal method.
- Within the European Union - The device that produces less waste and is easier to recycle is classified as electronic device in terms of the European Directive 2012/19/EU (WEEE), and must not be disposed of as domestic garbage.

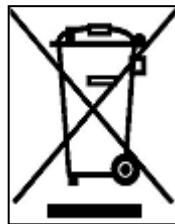

EU-wide legislation, as implemented in each Member State, requires that waste electrical and electronic products carrying the mark (left) must be disposed of separately from normal household waste. This includes monitors and electrical accessories, such as signal cables or power cords.

When you need to dispose of your display products, please follow the guidance of your local authority, or ask the shop where you purchased the product. The mark on electrical and electronic products only applies to the current European Union Member States.

Please follow the national guidelines for electrical and electronic product disposal.

D.2 Maintenance and Cleaning Precautions

When maintaining or cleaning the TANK-880-Q370 Series, please follow the guidelines below.

TANK-880-Q370

D.2.1 Maintenance and Cleaning

Prior to cleaning any part or component of the TANK-880-Q370 Series, please read the details below.

- The interior of the TANK-880-Q370 Series does not require cleaning. Keep fluids away from the TANK-880-Q370 Series interior.
- Be cautious of all small removable components when vacuuming the TANK-880-Q370 Series.
- Turn the TANK-880-Q370 Series off before cleaning the TANK-880-Q370 Series.
- Never drop any objects or liquids through the openings of the TANK-880-Q370 Series.
- Be cautious of any possible allergic reactions to solvents or chemicals used when cleaning the TANK-880-Q370 Series.
- Avoid eating, drinking and smoking within vicinity of the TANK-880-Q370 Series.

D.2.2 Cleaning Tools

Some components in the TANK-880-Q370 Series may only be cleaned using a product specifically designed for the purpose. In such case, the product will be explicitly mentioned in the cleaning tips. Below is a list of items to use when cleaning the TANK-880-Q370 Series.

- **Cloth** – Although paper towels or tissues can be used, a soft, clean piece of cloth is recommended when cleaning the TANK-880-Q370 Series.
- **Water or rubbing alcohol** – A cloth moistened with water or rubbing alcohol can be used to clean the TANK-880-Q370 Series.
- **Using solvents** – The use of solvents is not recommended when cleaning the TANK-880-Q370 Series as they may damage the plastic parts.
- **Vacuum cleaner** – Using a vacuum specifically designed for computers is one of the best methods of cleaning the TANK-880-Q370 Series. Dust and dirt can restrict the airflow in the TANK-880-Q370 Series and cause its circuitry to corrode.

- **Cotton swabs** - Cotton swabs moistened with rubbing alcohol or water are excellent tools for wiping hard to reach areas.
- **Foam swabs** - Whenever possible, it is best to use lint free swabs such as foam swabs for cleaning.

Appendix

E

Digital I/O Interface

E.1 Introduction

The DIO connector on the TANK-880-Q370 Series is interfaced to GPIO ports on the Super I/O chipset. The DIO has both 4-bit digital inputs and 4-bit digital outputs. The digital inputs and digital outputs are generally control signals that control the on/off circuit of external devices or TTL devices. Data can be read or written to the selected address to enable the DIO functions.



NOTE:

For further information, please refer to the datasheet for the Super I/O chipset.

The BIOS interrupt call **INT 15H** controls the digital I/O.

INT 15H:

AH – 6FH
<u>Sub-function:</u>
AL – 8 : Set the digital port as INPUT
AL : Digital I/O input value

TANK-880-Q370

E.2 Assembly Language Sample 1

```

MOV     AX, 6F08H      ;setting the digital port as input
INT     15H           ;

```

AL low byte = value

AH – 6FH
<u>Sub-function:</u>
AL – 9 : Set the digital port as OUTPUT
BL : Digital I/O input value

E.3 Assembly Language Sample 2

```

MOV     AX, 6F09H      ;setting the digital port as output
MOV     BL, 09H        ;digital value is 09H
INT     15H           ;

```

Digital Output is 1001b

Appendix

F

Error Beep Code

TANK-880-Q370

F.1 PEI Beep Codes

Number of Beeps	Description
1	Memory not Installed
1	Memory was installed twice (InstallPeiMemory routine in PEI Core called twice)
2	Recovery started
3	DXE IPL was not found
3	DXE Core Firmware Volume was not found
4	Recovery failed
4	S3 Resume failed
7	Reset PPI is not available

F.2 DXE Beep Codes

Number of Beeps	Description
1	Invalid password
4	Some of the Architectural Protocols are not available
5	No Console Output Devices are found
5	No Console Input Devices are found
6	Flash update is failed
7	Reset protocol is not available
8	Platform PCI resource requirements cannot be met

**NOTE:**

If you have any question, please contact IEI for further assistance.

Appendix

G

Hazardous Materials Disclosure

TANK-880-Q370

G.1 RoHS II Directive (2015/863/EU)

The details provided in this appendix are to ensure that the product is compliant with the RoHS II Directive (2015/863/EU). The table below acknowledges the presences of small quantities of certain substances in the product, and is applicable to RoHS II Directive (2015/863/EU).

Please refer to the following table.

Part Name	Toxic or Hazardous Substances and Elements									
	Lead (Pb)	Mercury (Hg)	Cadmium (Cd)	Hexavalent Chromium (CR(VI))	Polybrominated Biphenyls (PBB)	Polybrominated Diphenyl Ethers (PBDE)	Bis(2-ethylhexyl) phthalate (DEHP)	Butyl benzyl phthalate (BBP)	Dibutyl phthalate (DBP)	Diisobutyl phthalate (DIBP)
Housing	O	O	O	O	O	O	O	O	O	O
Printed Circuit Board	O	O	O	O	O	O	O	O	O	O
Metal Fasteners	O	O	O	O	O	O	O	O	O	O
Cable Assembly	O	O	O	O	O	O	O	O	O	O
Fan Assembly	O	O	O	O	O	O	O	O	O	O
Power Supply Assemblies	O	O	O	O	O	O	O	O	O	O
Battery	O	O	O	O	O	O	O	O	O	O
<p>O: This toxic or hazardous substance is contained in all of the homogeneous materials for the part is below the limit requirement in Directive (EU) 2015/863.</p> <p>X: This toxic or hazardous substance is contained in at least one of the homogeneous materials for this part is above the limit requirement in Directive (EU) 2015/863.</p>										

G.2 China RoHS

此附件旨在确保本产品符合中国 RoHS 标准。以下表格标示此产品中某有毒物质的含量符合中国 RoHS 标准规定的限量要求。

本产品上会附有“环境友好使用期限”的标签，此期限是估算这些物质“不会有泄漏或突变”的年限。本产品可能包含有较短的环境友好使用期限的可替换元件，像是电池或灯管，这些元件将会单独标示出来。

部件名称	有毒有害物质或元素					
	铅 (Pb)	汞 (Hg)	镉 (Cd)	六价铬 (CR(VI))	多溴联苯 (PBB)	多溴二苯醚 (PBDE)
壳体	○	○	○	○	○	○
印刷电路板	○	○	○	○	○	○
金属螺帽	○	○	○	○	○	○
电缆组装	○	○	○	○	○	○
风扇组装	○	○	○	○	○	○
电力供应组装	○	○	○	○	○	○
电池	○	○	○	○	○	○

○: 表示该有毒有害物质在该部件所有物质材料中的含量均在 SJ/T11364-2014 與 GB/T26572-2011 标准规定的限量要求以下。

X: 表示该有毒有害物质至少在该部件的某一均质材料中的含量超出 SJ/T11364-2014 與 GB/T26572-2011 标准规定的限量要求。