

Jetson Platform

AIB-SO21/SO31

AIB-SN31/SN41

USER MANUAL

Document Change History

Version	Date	Description
V1.0	2023/02/12	Initial Release
V1.1	2023/03/24	Updated support information, Specifications

Disclaimer

The information presented in this document is for informational purposes only and may contain technical inaccuracies, omissions and typographical errors.

The information contained herein is subject to change and may be rendered inaccurate for many reasons, including but not limited to product and roadmap changes, component and motherboard version changes, new model and/or product releases, product differences between differing manufacturers, software changes, BIOS flashes, firmware upgrades, or the like. Aetina assumes no obligation to update or otherwise correct or revise this information. However, Aetina reserves the right to revise this information and to make changes from time to time to the content hereof without obligation of Aetina to notify any person of such revisions or changes.

Aetina makes no representations or warranties with respect to the contents hereof and assumes no responsibility for any inaccuracies, errors or omissions that may appear in this information. Aetina specifically disclaims any implied warranties of merchantability or fitness for any particular purpose. In no event will Aetina be liable to any person for any direct, indirect, special or other consequential damages arising from the use of any information contained herein, even if Nvidia is expressly advised of the possibility of such damages.

Copyright Notice

No part of this manual may be reproduced, copied, translated, or transmitted in any form or by any means without the prior written permission of the original manufacturer. Information provided in this manual is intended to be accurate and reliable. However, the original manufacturer assumes no responsibility for its use, or for any infringements upon the rights of third parties that may result from its use.

The material in this document is for product information only and is subject to change without notice. While reasonable efforts have been made in the preparation of this document to assure its accuracy, Aetina assumes no liabilities resulting from errors or omissions in this document, or from the use of the information contained herein.

Aetina reserves the right to make changes in the product design without notice to its users.

Version 1.0

Copyright©2022 by Aetina, Inc. All rights reserved.

Acknowledgements

All other products' name or trademarks are properties of their respective owners.

- NVIDIA®, the NVIDIA logo, Jetson™ and Jetson Xavier™ are trademarks of the NVIDIA Corporation
- Intel®, Core™ are trademarks of Intel®, Corporation.
- Microsoft Windows® is a registered trademark of Microsoft Corp
- IBM and VGA are trademarks of International Business Machines Corporation.
- Ubuntu is a registered trademark of Canonical
- ESS is a trademark of ESS Technology, Inc.

All other product names or trademarks are properties of their respective owners. No ownership is implied or assumed for products, names or trademarks not herein listed by the publisher of this document. For more information about this and other Aetina products, please visit our web-site at: <http://www.Aetina.com/>

Customer Support Overview

Contact your distributor, sales representative, or Aetina's customer service center for technical support if you need additional assistance. Please have the following information ready before you call:

- Product name and serial number
- Description of your peripheral attachments
- Description of your software (operating system, version, application software, etc.)
- A complete description of the problem
- The exact wording of any error messages

Visit the Aetina website at <https://www.Aetina.com/support-warranty-policy.php> where you can find the latest information about the product.

Contact Information

Aetina Corporation | Headquarters

2F-1, No.237, Sec.1, Datong Rd., Xizhi Dist., New Taipei City 221, TAIWAN

Phone +886-2-7709 2568

Fax +886-2-7746 1102

Mail sales@Aetina.com

Worldwide Technical Support

Mail Tech_support@aetina.com

Product Warranty (2 years)

Aetina warrants to you, the original purchaser, that each of its products will be free from defects in materials and workmanship for two years from the date of purchase.

This warranty does not apply to any products which have been repaired or altered by persons other than repair personnel authorized by Aetina, or which have been subject to misuse, abuse, accident or improper installation. Aetina assumes no liability under the terms of this warranty as a consequence of such events.

Because of Aetina's high quality-control standards and rigorous testing, most of our customers never need to use our repair service. If an Aetina product is defective, it will be repaired or replaced at no charge during the warranty period. For out of warranty repairs, you will be billed according to the cost of replacement materials, service time and freight. Please consult your dealer for more details.

If you think you have a defective product, follow these steps:

1. Collect all the information about the problem encountered. (For example, CPU speed, Aetina products used other hardware and software used, etc.) Note anything abnormal and list any onscreen messages you get when the problem occurs.
2. Call your dealer and describe the problem. Please have your manual, product, and any helpful information readily available.
3. If your product is diagnosed as defective, obtain an RMA (return merchandise authorization) number from your dealer. This allows us to process your return more quickly.
4. Carefully pack the defective product, a fully-completed Repair and Replacement Order Card and a photocopy of the proof of purchase date (such as your sales receipt) in a shippable container. A product returned without proof of the purchase date is not eligible for warranty service.
5. Write the RMA number visibly on the outside of the package and ship it prepaid to your dealer.

ESD Warning

This product, like all electronic products, uses the product that can be damaged by electrostatic discharge (ESD). When handling, care must be taken so that the devices are not damaged. Damage due to inappropriate handling is not covered by the warranty. The following precautions must be taken:

- Do not open the protective conductive packaging until you have read the following and are at an approved anti-static workstation.
- If working on a prototyping board, use a soldering iron or station that is marked as ESD-safe.
- Always disconnect the product from the prototyping board when it is being worked on.
- Always discharge yourself by touching a grounded bare metal surface or approved anti-static mat before picking up an ESD - sensitive electronic component.
- Use an approved anti-static mat to cover your work surface.

Safety Precautions

Please read the following safety instructions carefully. It is advised that you keep this manual for future references:

1. All cautions and warnings on the equipment should be noted.
2. Make sure the power source matches the power rating of the device.
3. Position the power cord so that people cannot step on it. Do not place anything over the power cord.
4. For plug-in equipment, the power outlet socket must be located near the equipment and must be easily accessible.
5. Disconnect this equipment from any AC outlet before cleaning. Use a damp cloth. Do not use liquid or spray detergents for cleaning.
6. Always completely disconnect the power before working on the system's hardware.
7. Keep this equipment away from humidity.
8. Put this equipment on a reliable surface during installation. Dropping it or letting it fall may cause damage.
9. The openings on the enclosure are for air convection. Protect the equipment from overheating. **DO NOT COVER THE OPENINGS.**
10. Be sure that the room in which you choose to operate your system has adequate air circulation. Ensure that the chassis cover is secure.
11. The chassis design allows cooling air to circulate effectively. An open chassis permits air leaks, which may interrupt and redirect the flow of cooling air from internal components.
12. Never pour any liquid into an opening. This may cause fire or electrical shock.
13. If the equipment is not used for a long time, disconnect it from the power source to avoid damage by transient overvoltage.
14. Never open the equipment. For safety reasons, the equipment should be opened only by qualified service personnel.
15. If any of the following situations arises, please the contact our service personnel:
 - Damaged power cord or plug
 - Liquid intrusion to the device
 - Exposure to moisture
 - Device is not working as expected or in a manner as described in this manual
 - The device is dropped or damaged
 - vi. Any obvious signs of damage displayed on the device

Contents

1. Introduction	7
1.1 Features	7
1.2 Specifications	8
2. Hardware Information	10
2.1 Block Diagram	10
2.2 Connectors, LEDs, and Switches Locations	11
2.3 Connectors and Switches Description	12
2.4 Connectors and Pinout	13
2.5 Power Consumption	24
2.6 Mechanical Dimensions	25
3. Software/BSP Installation	26
4. Recovery Mode	26
5. Initial Setup	27
5.1 Prepare the materials	27
5.2 Hardware connection	27
5.3 Setup details	27

1. Introduction

AIB-SO21/31 & AIB-SN31/41 series supports NVIDIA Jetson Orin Nano & NX series modules, and you can quickly emulate the functionality of your desired end product for software development and hardware verification.

To build a functional prototype of your target system you will need:

- NVIDIA Jetson Orin Nano 4/8GB & NX 8/16GB module
- Carrier board
- Power adaptor



1.1 Features

- Support NVIDIA Jetson Orin Nano 4/8GB & NX 8/16GB
- Storage supports M.2 2242 NVMe (128GB built-in)
- 1 x M.2 E-Key 2230 slot
- 1 x RJ-45 GbE Port
- Wide Power Input Range 12 to 24 VDC
- Operating Temperature -25° C ~ 80° C
- Support OOB (out-of-band) powered by Innodisk (optional)

1.2 Specifications

■ Carrier board specifications

Specification	AIB-SO21/31	AIB-SN31/41
Module Compatibility	Nvidia Jetson Orin Nano 4/8GB	Nvidia Jetson Orin NX 8/16GB
AI Performance	20/40 TOPS	70/100 TOPS
GPU	512 Core NVIDIA Ampere, with 16 Tensor Cores 1024 Core NVIDIA Ampere, with 32 Tensor Cores	1024 Core NVIDIA Ampere, with 32 Tensor Cores
CPU	6-core Arm® Cortex®-A78AE v8.2 64-bit 1.5MB L2 + 4MB L3	6-core Arm® Cortex®-A78AE v8.2 64-bit 1.5MB L2 + 4MB L3 8-core Arm® Cortex®-A78AE v8.2 64-bit 2MB L2 + 4MB L3
Memory	4GB 64-bit LPDDR5 34 GB/s 8GB 128-bit LPDDR5 68 GB/s	8GB 128-bit LPDDR5 102.4 GB/s 16GB 128-bit LPDDR5 102.4 GB/s
Storage	1 x M.2 M-Key 2242 (128GB built-in)	
Display	1 x HDMI 2.0 Type A	
Audio	LINE IN/OUT, Microphone (optional with daughter board)	
Camera Input	2 x 4-Lane MIPI CSI-2 22-Pin Connector	
LAN	1 x RJ-45 GbE Port	
USB	2 x USB 3.2 Gen2 Type-A 1 x OTG Type-C	
I/O Interfaces	5 x GPIO, 1 x I2C, 1 x I2S, 1 x RS-232, 1 x UART, 1 x UART (Debug Only), 1 x SPI, 1 x CAN	
Expansion	1 x M.2 E-Key 2230 (support PCIe x1 Gen3, USB 2.0) 1 x M.2 M-Key 2242 (128GB built-in, support NVMe, PCIe x4 Gen3)	1 x M.2 E-Key 2230 (support PCIe x1 Gen4, USB 2.0) 1 x M.2 M-Key 2242 (128GB built-in, support NVMe, PCIe x4 Gen4)
MISC. Function	1 x Power/Recovery/Reset Button 1 x RS-232 1 x CAN 2.0b with isolation	
Power Consumption	Idle: 5.5 W	Idle: 4.6 W

	Full Loading: 27.25 W	Full Loading: 37.25 W
	Idle configuration: Connect with Keyboard, Mouse and HDMI Display Full Loading configuration: Connect with Keyboard, Mouse and HDMI Display with CPU and GPU 100% Loading	
Power Input/ Connector	DC-in 12-24 VDC/2-Pin Terminal Block	
Dimension (W x D x H)	87.4 x 67.4 x 28.45 mm (3.44 x 2.65 x 1.12 in)	
Net Weight	0.144 kg (0.32 lb) w/ Fansink	
Temperature	Operating Temp.: -25° C ~ 80° C (-13° F ~ 176° F) Storage Temp.: -40° C ~ 85° C (-40° F ~ 185° F)	
Humidity	95% @ 40° C Related Humidity, Non-condensing	
Certification	CE/FCC Class A, IEC 62368	

2. Hardware Information

2.1 Block Diagram

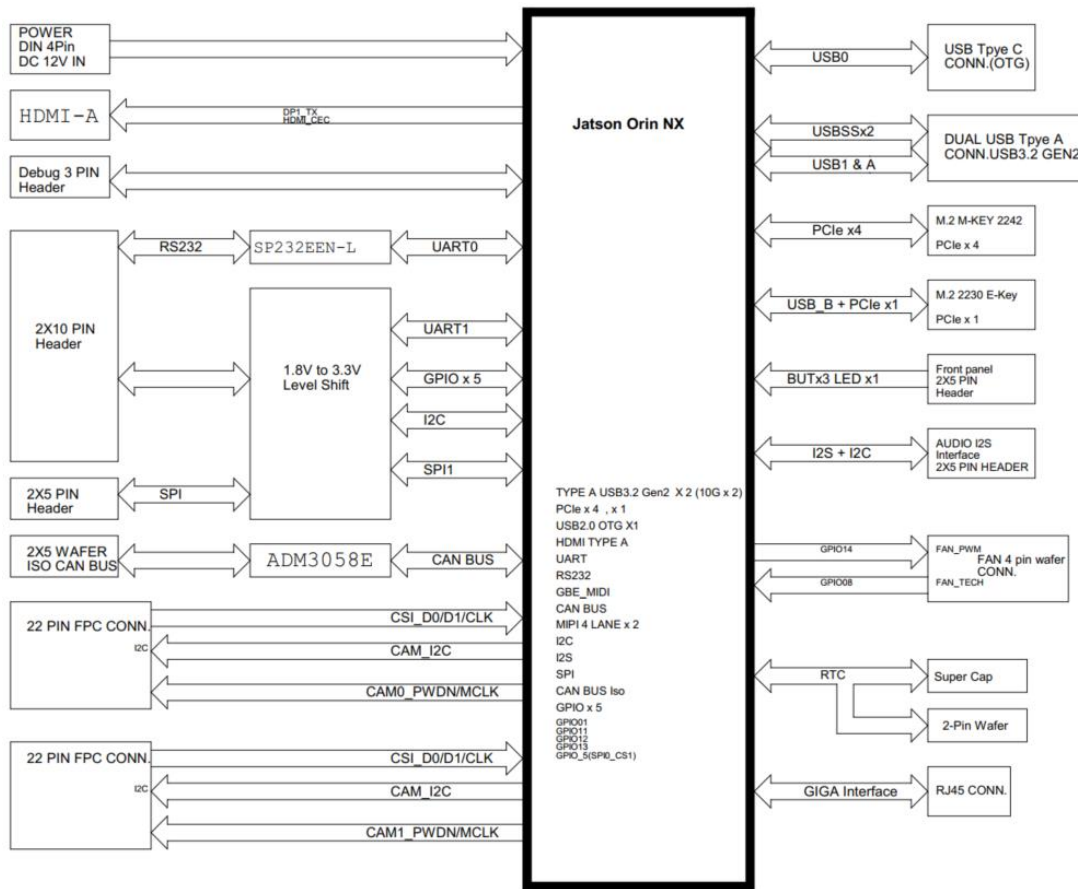

AIB-SO21/31 & AIB-SN31/41 Block diagram

2.2 Connectors, LEDs, and Switches Locations

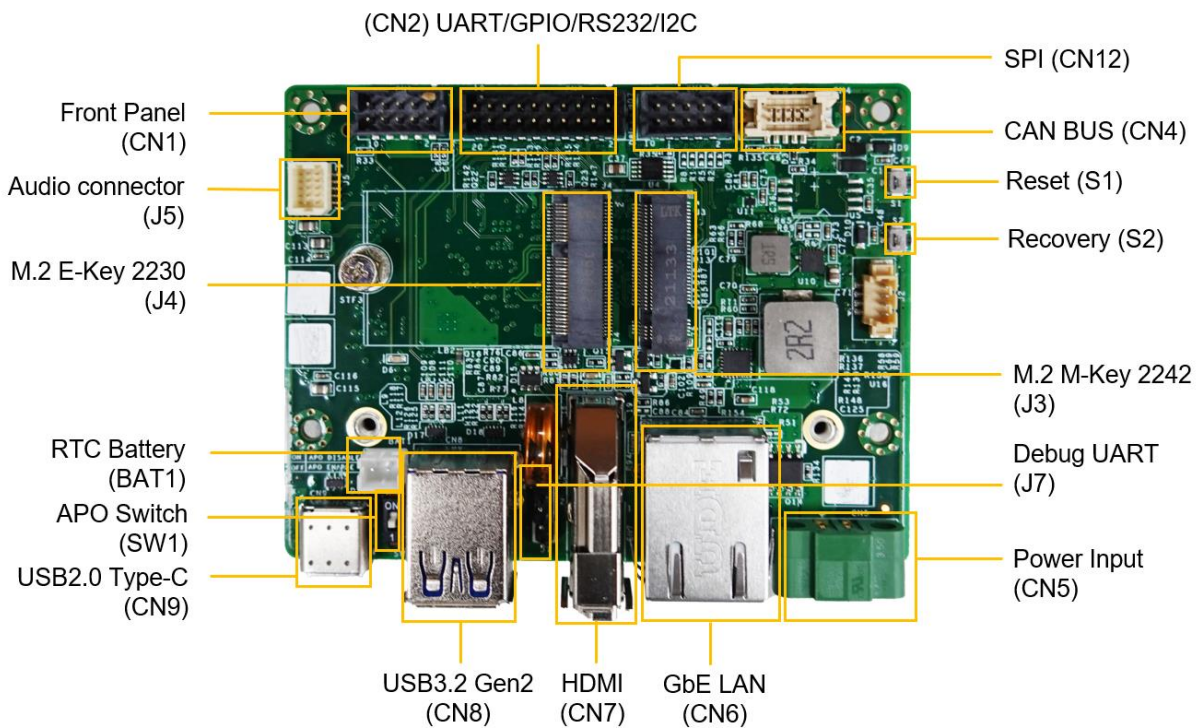
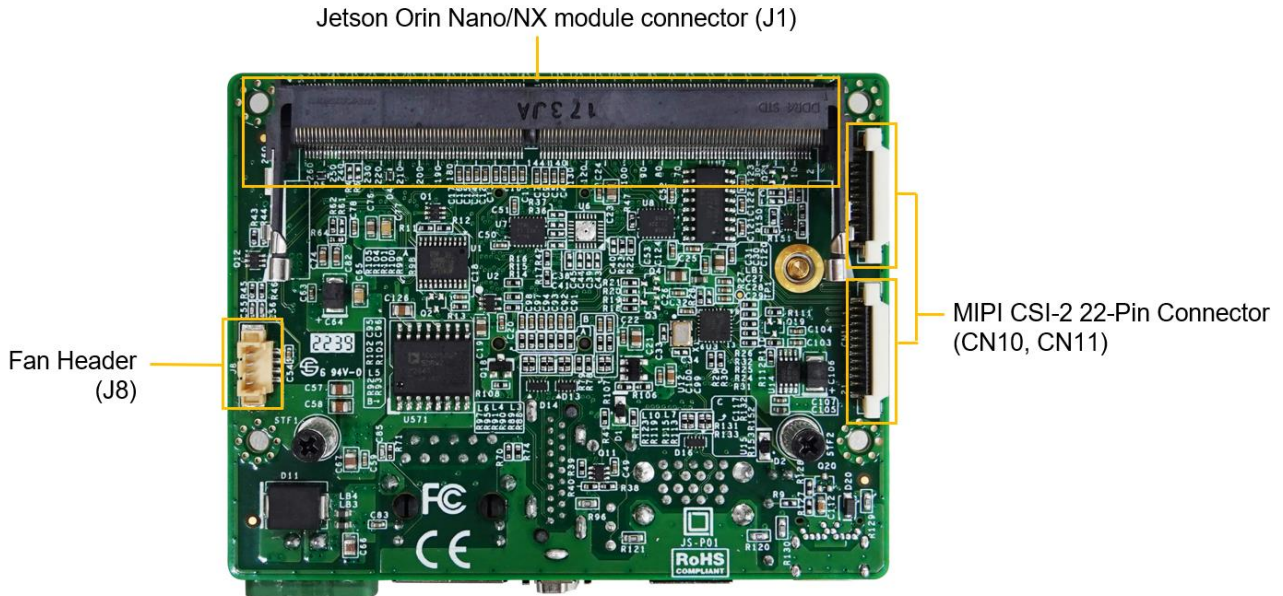

2.3 Connectors and Switches Description

Item	Detail
J1	Jetson Orin Nano/NX connector
CN7	HDMI 2.0 Type-A connector
J3	M.2 M-Key 2242 connector (support NVMe, PCIe x4 Gen3 for Orin Nano/ PCIe x4 Gen4 for Orin NX)
J4	M.2 E-Key 2230 connector (support USB 2.0, PCIe x1 Gen3 for Orin Nano/ PCIe x1 Gen4 for Orin NX)
CN8	2 x USB 3.2 Gen2 Type-A
CN10, CN11	2 x 4-Lane MIPI CSI-2 22-Pin connector
CN9	OTG Type-C
CN6	1 x RJ-45 GbE Port
CN2	2 x 10P P:2.0 support RS232/GPIO/I2C/UART
CN4	2 x 5P P:1.25 support CAN BUS function
CN12	2 x 5P P:1.25 support SPI function
J8	1 x 4P P:1.25 Module Fan
CN1	2 x 5P P:1.25 Front Panel
CN5	DC Power input connector
J5	2 x 5P P ^m 1.0 Audio connector (optional with daughter board)
J7	Debug UART
SW1	To enable APO function by switch
BAT1	1 x 2P P:2.0 RTC Connector (optional with battery)
S1	Reset Button
S2	Recovery Button
J2	Aetina internal use

2.4 Connectors and Pinout

Here are the connectors and pinout information of AIB-SO21/31 & AIB-SN31/41 carrier board below.

■ Jetson Orin Nano/NX Module Connector

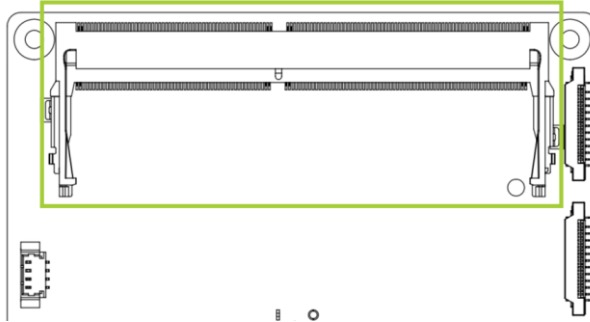

Item	Description
Location	J1
Type	DDR4 SODIMM 260-Pin
Pinout	Please refer to NVIDIA Jetson Orin Nano/NX System-on-Module datasheet

■ MIPI CSI-2 22-Pin Connectors

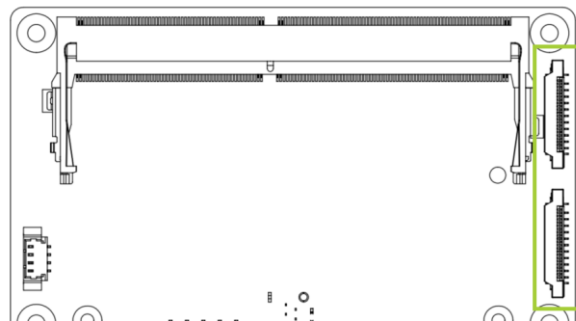

Item	Description
Location	CN10/CN11
Type	4-Lane MIPI CSI-2 22-pin connector
Notes	support FFC/FPC cable

Pin #	Definition	Pin #	Definition
1	VDD_3V3	2	CAMA_I2C_SDA
3	CAMA_I2C_SCL	4	GND
5	CAM_CK0	6	CAM_PD0

7	GND	8	CSIA_D3P
9	CSIA_D3N	10	GND
11	CSIA_D2P	12	CSIA_D2N
13	GND	14	CSIA_CKP
15	CSIA_CKN	16	GND
17	CSIA_D1P	18	CSIA_D1N
19	GND	20	CSIA_D0P
21	CSIA_D0N	22	GND

■ HDMI Type-A Connector

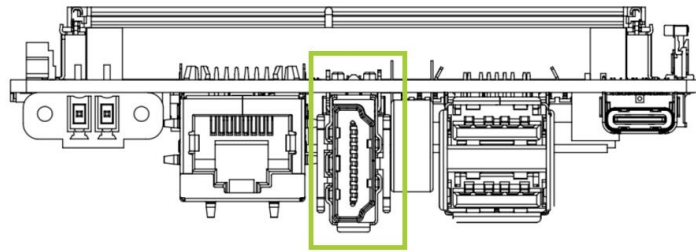

Item	Description
Location	CN7
Type	HDMI Type-A female connector
Pinout	Please refer to HDMI Type-A Standard

■ M.2 M-Key Connector

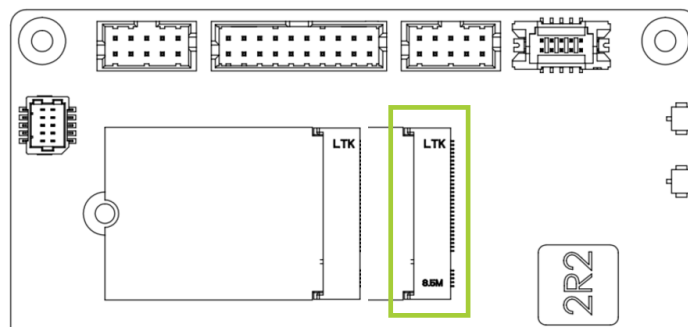

Item	Description
Location	J3
Type	M.2 M-Key 2242
Pin	Please refer to M.2 M-Key Standard

Notes

128 GB storage built-in
support NVMe, PCIe x4 Gen3 for Orin Nano/PCIe x4 Gen4 for Orin NX)

■ M.2 E-Key Connector

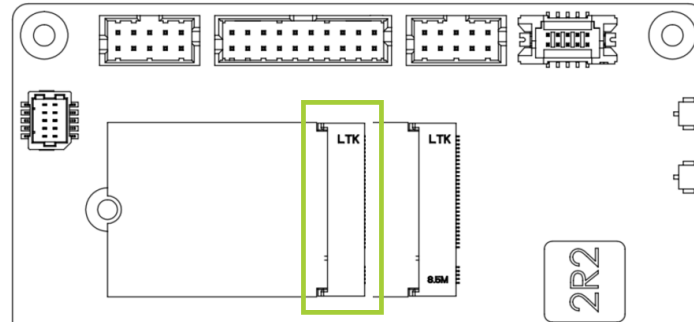

Item	Description
Location	J4
Type	M.2 E-Key 2230
Pin	Refer to M.2 E-Key Standard
Notes	support USB 2.0, PCIe x1 Gen3 for Orin Nano/PCIe x1 Gen4 for Orin NX

■ DC Power Input Terminal Block

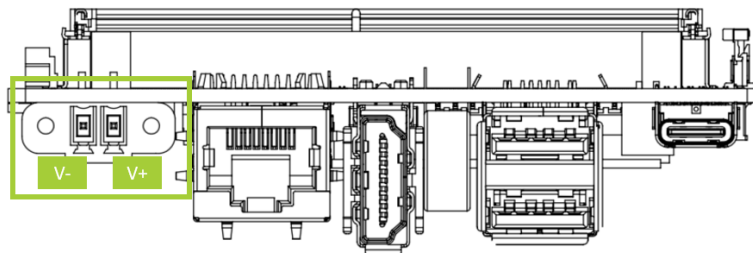

Item	Description
Location	CN5
Type	2-Pin Terminal Block
Notes	V+ : VIN V- : GND

■ **Dual USB 3.2 Gen2 Type-A Connector**

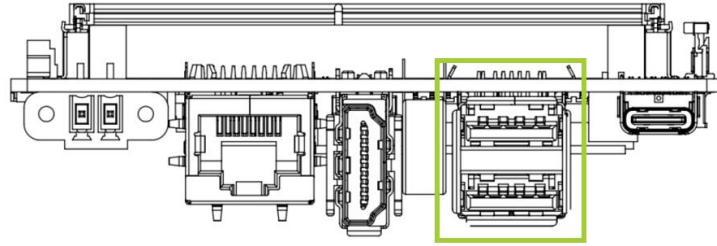

Item	Description
Location	CN8
Type	Type-A USB connector
Pinout	Please refer to USB Standard

■ **OTG Type-C Connector**

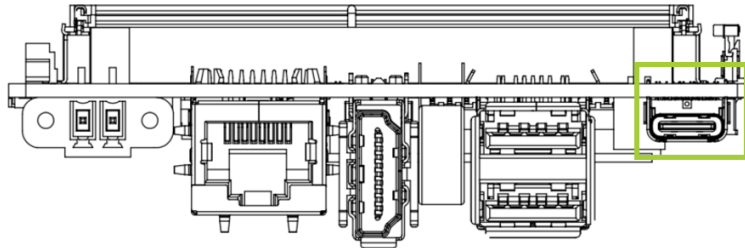

Item	Description
Location	CN9
Type	USB TYPE-C connector
Pinout	Please refer to USB standard
Notes	support OTG function only

■ **Gigabit Ethernet Connector**

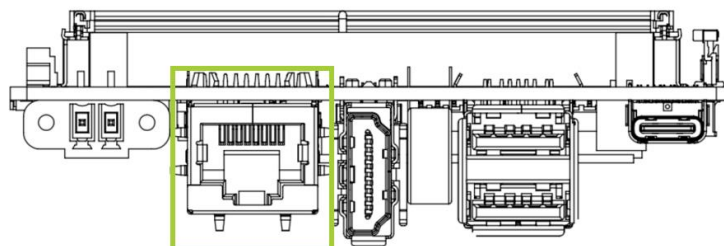

Item	Description
Location	CN6
Type	RJ-45 connector

Pinout	Please refer to Ethernet standard
Notes	LED Static ON: LAN Link is active. LED Blinking: Data is being transmitted. LED Static OFF: LAN Link is inactive.

■ **CAN BUS Connector**

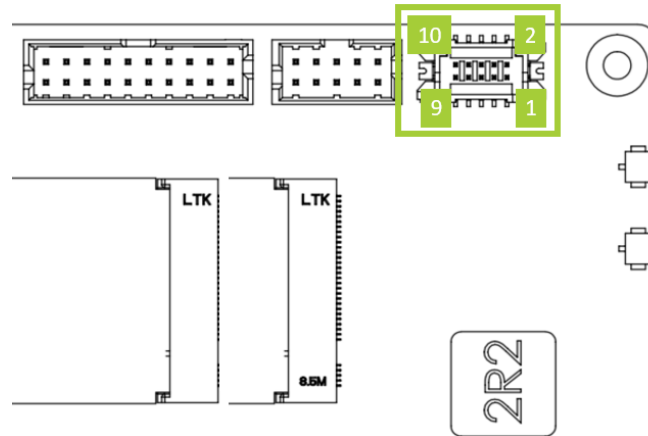

Item	Description
Location	CN4
Type	2*5P 1 P:1.25mm H:4.8mm Wafer connector
Notes	5.7kVrms Isolation

Pin #	Definition	Pin #	Definition
1	CAN0H	2	NC
3	CAN0L	4	NC
5	NC	6	NC
7	CAN_5V	8	NC
9	CAN1_GND	10	NC

■ MISC I/O Connector (RS232/GPIO/I2C/UART)

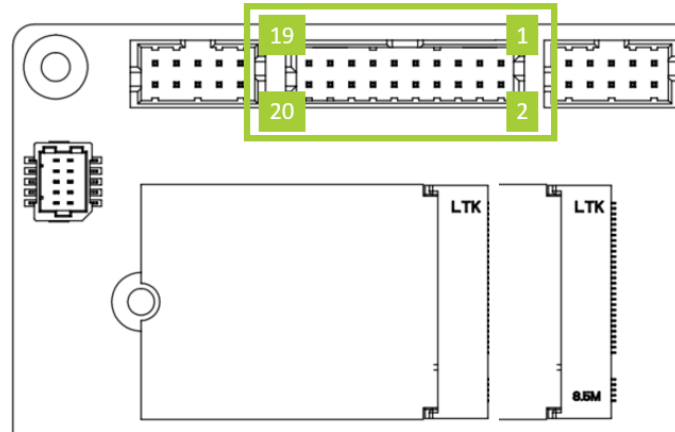

Item	Description
Location	CN2
Type	2*10P P:2.0mm H:7mm Pin header

Pin #	Definition	Notes	Pin #	Definition
1	VDD_3V3		2	VDD_5V
3	GPIO_1 (GPIO01 / PQ.05 453)	IN/OUT	4	UART_TXD
5	GPIO_2 (GPIO11 / PQ.06 454)	IN/OUT	6	UART_RXD
7	GPIO_3 (GPIO12 / PN.01 433)	IN/OUT	8	UART_CTS
9	GPIO_4 (GPIO13 / PH.00 391)	IN/OUT	10	UART_HDR
11	GPIO_5 (GPIO05 / PZ.07 485)	IN/OUT	12	RS232_RXD
13	I2C_CLK		14	RS232_RTS
15	I2C_DAT		16	RS232_TXD
17	GND		18	RS232_CTS
19	GND		20	GND

■ Front Panel Connector

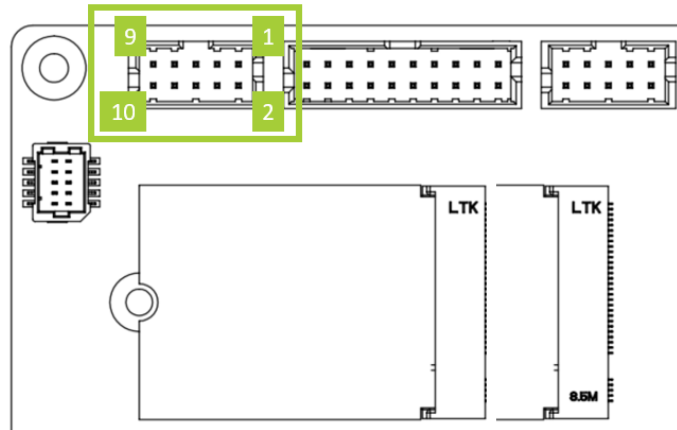

Item	Description
Location	CN1
Type	2*5P P:2.0mm H:7mm Wafer connector

Pin #	Definition	Pin #	Definition
1	Power On	2	GND
3	Reset	4	GND
5	Recovery	6	GND
7	Sleep	8	GND
9	LED+	10	LED-

■ SPI Connector

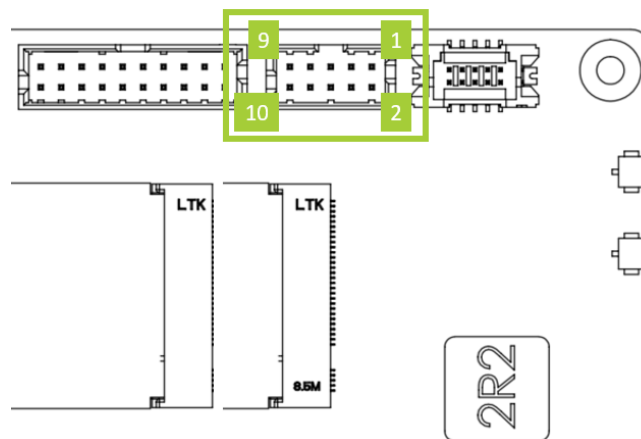

Item	Description
Location	CN12
Type	2*5P P:2.0mm H:7mm Wafer connector

Pin #	Definition	Pin #	Definition
1	VDD_3V3_OUT	2	5V_OUT
3	SPI1_CS1_3V3	4	SPI1_MOSI_3V3
5	SPI1_CS0_3V3	6	SPI1_SCK_3V3
7	NC	8	SPI1_MISO_3V3
9	GND	10	GND

■ RTC Battery Connector

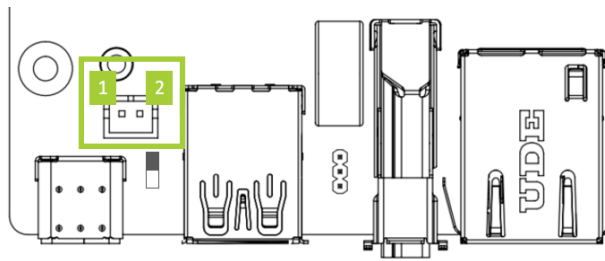

Item	Description
Location	BAT1
Type	1*2P P:2.0mm connector

Pin #	Definition
1	—
2	+

■ Debug UART

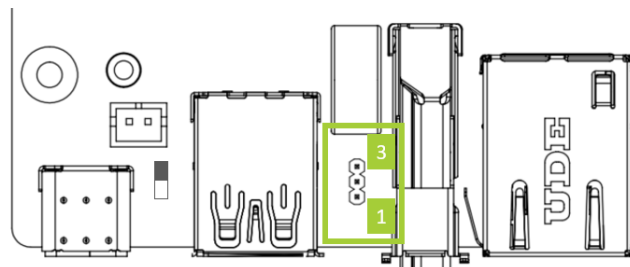

Item	Description
Location	J7
Type	1*3P P:2.54mm Pin connector

Pin #	Definition
1	Debug_UART_RX
2	Debug_UART_TX
3	GND

■ Auto Power ON (APO) Switch

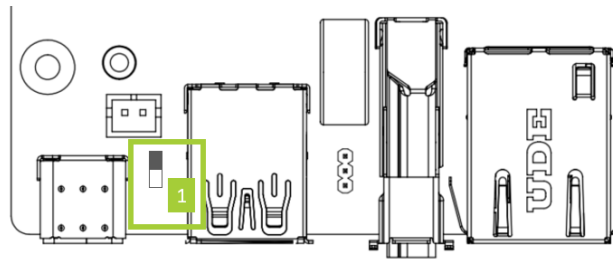

Item	Description
Location	SW1
Type	DIP Switch
Notes	To enable APO function by Switch

Position	Function
ON	Disable APO
1 (Default)	Enable APO

■ 5V Fan Connector

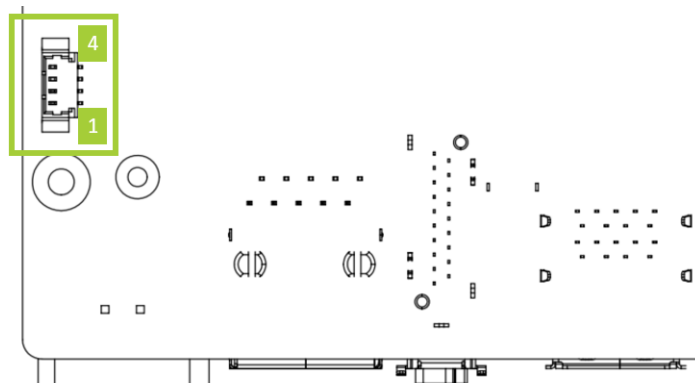

Item	Description
Location	J8
Type	1*4P 1.25mm Wafer connector

Pin #	Definition	Pin #	Definition
1	GND	2	VDD_5V
3	TACH	4	PWM

■ Audio Board-to-Board Connector

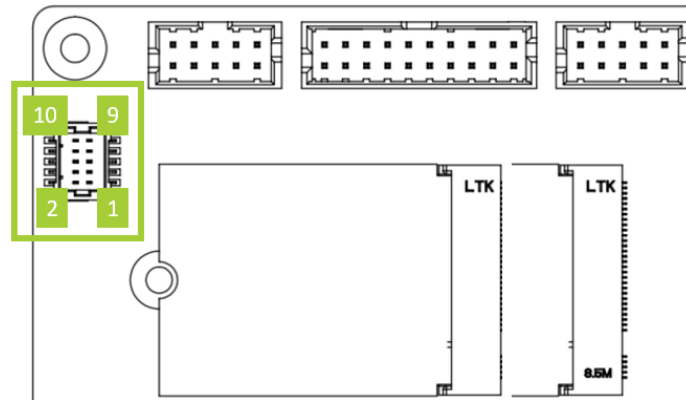

Item	Description
Location	J5
Type	2*5P P:1.0mm Wafer connector

Pin #	Definition	Pin #	Definition
1	I2S_SCLK	2	VDD_3V3
3	I2S_OUT	4	I2C_DAT
5	I2S_IN	6	I2C_CLK
7	I2S_FS	8	GND
9	I2S_MCLK	10	GND

Note: The voltage level of I2C & I2S is 1.8V

■ **Reset Button**

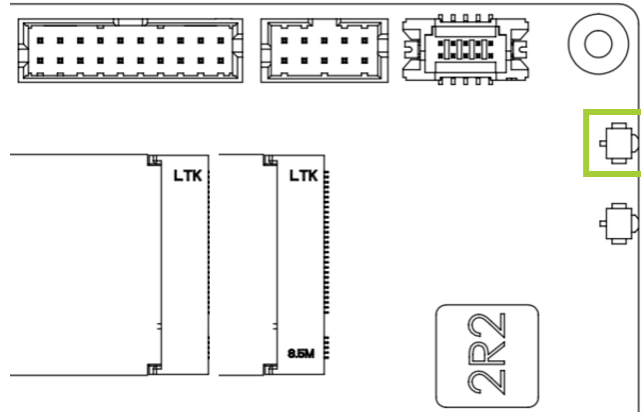

Item	Description
Location	S1
Type	Tact switch
Notes	To trigger system reset action

■ **Recovery Button**

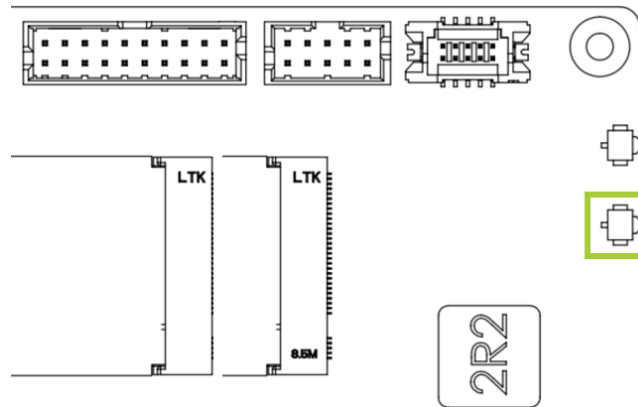

Item	Description
Location	S2
Type	Tact switch
Notes	To trigger system recovery action

2.5 Power Consumption

The power consumption shown as below is the theoretical value with Orin Nano module installed on AIB-SO21/AIB-SO31.

Type	Theoretical Maximum System power
Idle	5.5 W (Connect with Keyboard, Mouse and HDMI Display)
Full Loading	27.25 W (Connect with Keyboard, Mouse and HDMI Display with CPU And GPU 100% Loading)

The power consumption shown as below is the theoretical value with Orin NX module installed on AIB-SN31/AIB-SN41.

Type	Theoretical Maximum System power
Idle	4.6 W (Connect with Keyboard, Mouse and HDMI Display)
Full Loading	37.25 W (Connect with Keyboard, Mouse and HDMI Display with CPU And GPU 100% Loading)

Please refer to the following power consumption of individual I/O interface according to your use case.

Type	Theoretical Maximum System power
HDMI	0.25 W
M.2 M key	7 W
M.2 E key	2 W
USB 3.2 Gen2 (1 port)	4.5 W
Camera MIPI CSI-2	8.4 W
USB 2.0	4.5 W
GbE LAN port	0.83 W
CAN Bus	1 W
Front panel	0.05 W
Fan connector	3 W

2.6 Mechanical Dimensions

Integration assembly drawing for AIB-SO21/31 AIB-SN31/41 carrier board, Orin Nano/NX module and Fansink

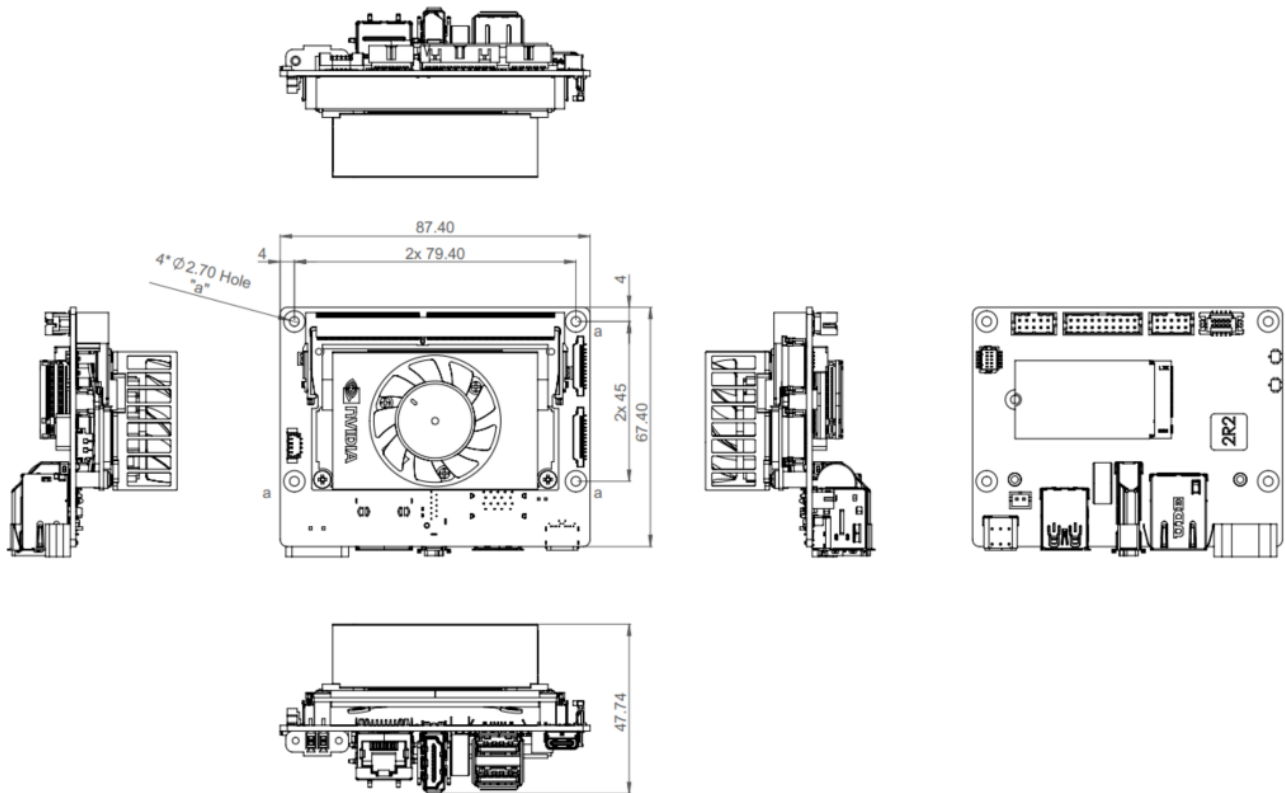

3. Software/BSP Installation

Aetina NVIDIA Jetson products have built-in BSP so the users don't have to install it after getting the products. Since we develop our own BSP, the users may need to follow the BSP installation SOP to re-install/upgrade/downgrade the BSP. Please visit the Aetina website or contact with Aetina FAE at Tech_support@aetina.com for installation guides, BSPs and technical tips.

4. Recovery Mode

The OTG Type-C port of AIB-SO21/31 or AIB-SN31/41 can be connected to another host device (Linux PC running NVIDIA Jetpack™) to run recovery process for re-flashing BSP.

Note: Please backup user personal files before flashing process

Step 1: Connect the OTG Type-C port to another host device which supplying updated BSP file.

Step 2: Press and hold the Reset button, then press and hold the Recovery button continually.

Step 3: After one second (1 sec.) release the Reset button first, then release the Recovery button.

Step 4: The Orin Nano or NX will show up as a new NVIDIA device on USB list (Terminal console) at the host device.

Step 5: Running re-flashing BSP process can be executed by the host device now.

5. Initial Setup

Before using AIB-SO21/31 & AIB-SN31/41 series, please follow the steps below to have initial setup.

5.1 Prepare the materials

Please prepare the materials list below.

- A monitor with HDMI and respective cables
- USB keyboard and mouse
- Ethernet cable

5.2 Hardware connection

ATTENTION: Jetson Orin module is not hot-pluggable. Before installing or removing the module, the main power supply (to Power connector, CN12) must be disconnected and adequate time allowed for the various power rails to fully discharge.

For the initial setup, users will need to connect LAN port, keyboard and mouse via USB interface, HDMI interface, and power connector.

5.3 Setup details

Step 1: Connect to the monitor while powering off

Step 2: Power on and automatically enter the OS

Step 3: Log in to the Ubuntu OS via credentials below

- Username: nvidia
- Password: nvidia

For more information on how to use Ubuntu and NVIDIA Jetson modules, please visit Ubuntu and NVIDIA website.



Aetina Corporation | Headquarters

2F-1, No.237, Sec.1, Datong Rd., Xizhi Dist., New Taipei City 221, TAIWAN

Phone: +886-2-7709 2568

Fax : +886-2-7746 1102

Mail : sales@Aetina.com

www.Aetina.com