

# I-7017RC, M-7017RC Quick Start Guide

## Warranty

All products manufactured by ICP DAS are under warranty regarding defective materials for a period of one year from the date of delivery to the original purchaser.

## Warning

ICP DAS assumes no liability for damages resulting from the use of this product. ICP DAS reserves the right to change this manual at any time without notification. The information furnished by ICP DAS is believed to be accurate and reliable. However, no responsibility is assumed by ICP DAS for its use, or for any infringements of patents or other rights of third parties resulting from its use.

## Packing List

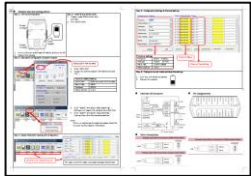
<p>I-7017RC or M-7017RC</p> 	<p>Plastic Rail</p> 	<p>CD</p> 	<p>Quick Start Guide</p> 
---	---	--	--

## Internal I/O Structure

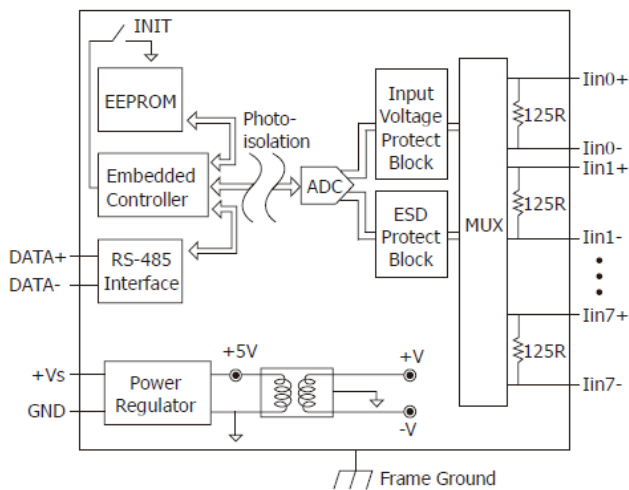

## Pin Assignments

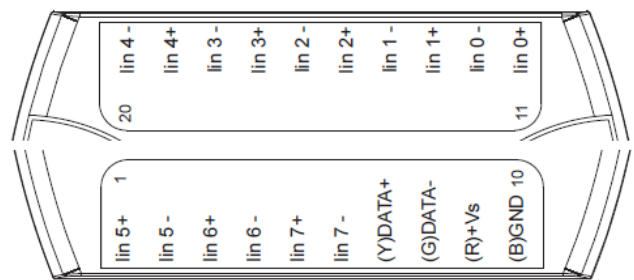

## Wire Connections

### Current Input Wire Connection

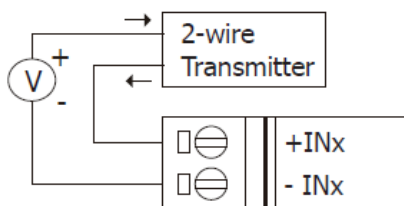
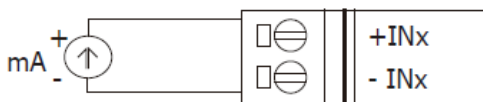

## ■ Modbus Table (M-7017R only)

Address	Description	R/W																				
10129 ~ 10136 00129 ~ 00136	Over/under range status of channel 0 to 7 for 4 ~ 20mA or 0 ~ 20mA ranges	R																				
30001 ~ 30008 40001 ~ 40008	Analog input value of channel 0 to 7	R																				
40481	Firmware version (low word)	R																				
40482	Firmware version (high word)	R																				
40483	Module name (low word)	R																				
40484	Module name (high word)	R																				
40485	Module address, valid range: 1 ~ 247	R/W																				
40486	Bits 5:0 Baud rate, 0x03 ~ 0x0A <table border="1" style="margin-left: 20px;"> <tr> <td>Code</td> <td>0x03</td> <td>0x04</td> <td>0x05</td> <td>0x06</td> </tr> <tr> <td>Baud</td> <td>1200</td> <td>2400</td> <td>4800</td> <td>9600</td> </tr> <tr> <td>Code</td> <td>0x07</td> <td>0x08</td> <td>0x09</td> <td>0x0A</td> </tr> <tr> <td>Baud</td> <td>19200</td> <td>38400</td> <td>57600</td> <td>115200</td> </tr> </table> Bits 7:6 00: no parity, 1 stop bit 01: no parity, 2 stop bit 10: even parity, 1 stop bit 11: odd parity, 1 stop bit	Code	0x03	0x04	0x05	0x06	Baud	1200	2400	4800	9600	Code	0x07	0x08	0x09	0x0A	Baud	19200	38400	57600	115200	R/W
Code	0x03	0x04	0x05	0x06																		
Baud	1200	2400	4800	9600																		
Code	0x07	0x08	0x09	0x0A																		
Baud	19200	38400	57600	115200																		
40487	Type code	R/W																				

Address	Description	R/W
40488	Modbus response delay time in ms, valid range: 0 ~ 30	R/W
40489	Host watchdog timeout value, 0 ~ 255, in 0.1s	R/W
40490	Channel enable/disable, 00h ~ FFh	R/W
40492	Host watchdog timeout count, write 0 to clear	R/W
00257	Protocol, 0: DCON, 1: Modbus RTU	R/W
00259	Filter setting, 0: 60Hz rejection, 1: 50Hz rejection	R/W
00261	1: enable, 0: disable host watchdog	R/W
00269	Modbus data format, 0: hex, 1: engineering	R/W
00270	Host watch dog timeout status, write 1 to clear host watch dog timeout status	R/W
00271	1: enable, 0: disable fast mode	R/W
00273	Reset status, 1: first read after powered on, 0: not the first read after powered on	R

## ■ DCON Protocol

Functions	Command	Response	Notes
Read module name	\$AAM	!AA(Data)	AA: address number
Read module firmware version	\$AAF	!AA(Data)	
Read all analog input data	#aa	>(data)	
Read analog input data of each channel (<=16 channel)	#aai	>(data)	i: channel number (Hex)
Read analog input data of each channel (>16 channel)	#aaii	>(data)	ii: channel number (Hex)

If you want to know the detail DCON protocol, please check it from CD or web

CD path: \\napdos\7000\manual\

Web: <ftp://ftp.icpdas.com/pub/cd/8000cd/napdos/7000/manual/>

## Module test and configuration

### Step 1: INIT switch Operation

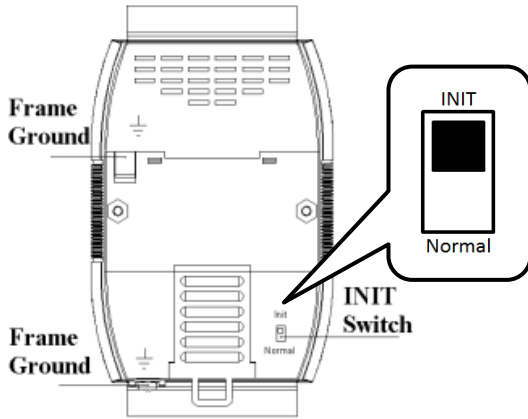

1. Find out the INIT switch( back of the module), and turn to INIT.
2. Reboot the module

### Step 2: Install & Run DCON Utility

1. Please Install DCON Utility first  
You can find the software in the CD.

CD path:

<Driver>:\napdos\driver\dcon\_utility\

Web link:

[http://ftp.icpdas.com/pub/cd/8000cd/napdos/driver/dcon\\_utility/](http://ftp.icpdas.com/pub/cd/8000cd/napdos/driver/dcon_utility/)

2. Run DCON utility



DCON\_UTILITY

### Step 3: Set search configuration & search module

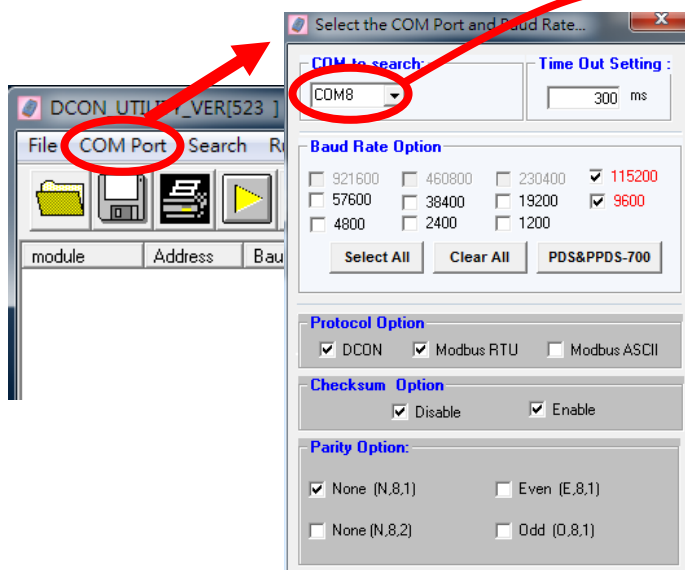

Select COM Port Number

1. Click "COM Port"
2. Assign the communication information and click "OK"

#### Module Default Setting

COM Port	Refer converter Port Number
Baud Rate	9600
Protocol	DCON for I-7000 Modbus RTU for M-7000
Parity Option	N,8,1

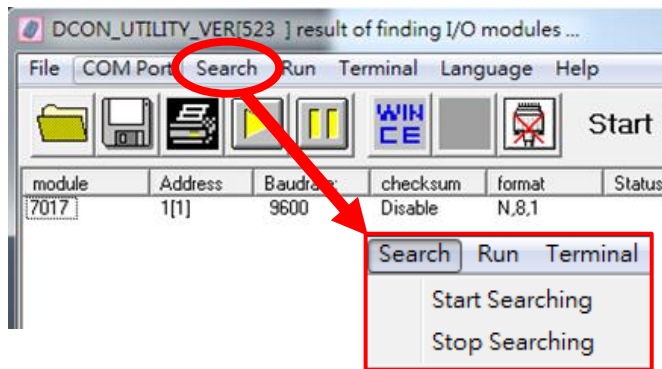

3. Click "Search" and select "Start Searching"  
Software will search the modules from COM Port
4. Click "Search" and select "stop searching"  
Manual stop when the modules searched

Note:

When no module can be searched, please check the wire and communication information

### Step 4: Select Module for testing and configuration

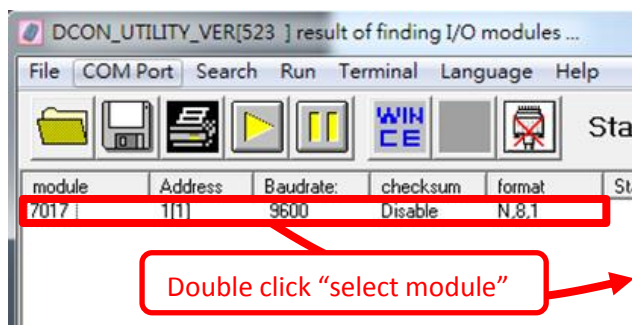

Double click "select module"

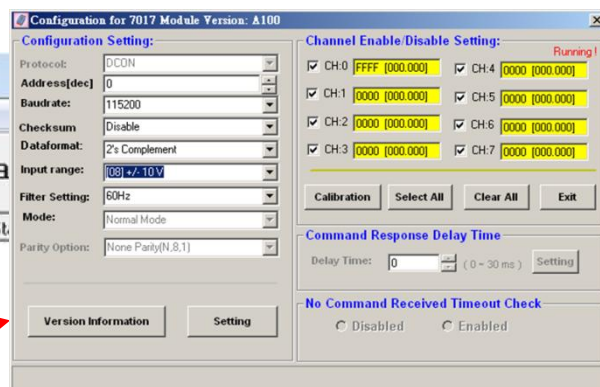

## Step 5: Configuration Settings & Channel Settings

Protocol	DCON / Modbus
Address	1~255 (0:INIT)
Baud rate	1200~115200
Parity option	N,8,1
Input range	Depends on signal sources

## Step 6: Change to normal mode and keep the settings

1. Turn the INIT Switch to Normal.
2. Reboot the module



## ■ Trouble Shooting

### Q1. How to do when forgot module address or baud rate?

Please turn to INIT mode, and run DCON Utility to search.  
The module supports DCON protocol at the INIT mode.  
And the address is 0. The communication setting is "9600,N,8,1".

### Q2. How to configure the I-7000 and M-7000 modules?

ICP DAS provide DCON Utility to configure I-7000 and M-7000 modules.  
Please download the last version from: [http://ftp.icpdas.com/pub/cd/8000cd/napdos/driver/dcon\\_utility/](http://ftp.icpdas.com/pub/cd/8000cd/napdos/driver/dcon_utility/)

### Q3. I-7017RC & M-7017RC are the current input modules. Do they need external resistors for the measurement?

No, please refer internal I/O structure.  
There is a 125Ω resistor inside for each channel.

### Q4. How to calibrate the analog input module?

Usually it is not necessary to calibrate the analog input module.  
However, in case you need to perform this operation, we provide a function to calibrate the module.  
Please refer to user manual 1.10.

Notice:

1. Please update DCON Utility to version 5.2.3 or more.
2. Keep the module running more than 30 minutes to warm-up.

### Q5. How to programming with I-7000 or M-7000 by C#, VB, VC?

ICP DAS I-7000 and M-7000 series both support DCON protocol. And Only M-7000 series supports Modbus protocol.  
For DCON protocol, please download SDK and Demo from:  
[http://ftp.icpdas.com/pub/cd/8000cd/napdos/driver/dcon\\_dll\\_new/](http://ftp.icpdas.com/pub/cd/8000cd/napdos/driver/dcon_dll_new/)  
For Modbus protocol, please refer this web link:  
<http://www.icpdas.com/products/PAC/i-8000/modbus.htm>

If there is any other question, please feel free to contact us. Email: [service@icpdas.com](mailto:service@icpdas.com)  
Website: [http://www.icpdas.com.tw/contact\\_us/contact\\_us.html](http://www.icpdas.com.tw/contact_us/contact_us.html)