

General Description

V700 PLC+HMI is programmable logic controller that comprise a built-in operating panel containing a 7" Color Touchscreen





| | |
|---|--|
| I/O Options | Snap-in I/O Modules / I/O Expansion Modules |
| Screen | 7" Color Touch |
| Keypad or Function Keys | None |
| Programming Com Port, Built-in | |
| RS232/485 | Yes* |
| USB device, mini-B | Yes* |
| Ethernet | Yes |
| Com Ports, separate order, installed by user | The user may install a CANbus port (V100-17-CAN), and one of the following: <ul style="list-style-type: none"> • RS232/RS485 port (V100-17-RS4/V100-17-RS4X) • Profibus Slave (V100-17-PB1) |
| * V700 comprises both RS232/485 and USB ports; note that only one channel may be used at a time. | |

Standard Kit Contents

| | |
|-------------------|---------------|
| Controller | Yes |
| Terminal Block | Yes (3 pin) |
| Battery | Yes |
| Mounting Brackets | Yes (4 parts) |
| Rubber Seal | Yes |

Alert Symbols and General Restrictions

When any of the following symbols appear, read the associated information carefully.

| Symbol | Meaning | Description |
|---|---|---|
|  | Danger | The identified danger causes physical and property damage. |
|  | Warning | The identified danger could cause physical and property damage. |
| <i>Caution</i> | Caution | Use caution. |
| <ul style="list-style-type: none"> • Before using this product, the user must read and understand this document. • All examples and diagrams are intended to aid understanding, and do not guarantee operation. Unitronics accepts no responsibility for actual use of this product based on these examples. • Please dispose of this product according to local and national standards and regulations. • Only qualified service personnel should open this device or carry out repairs. | | |
|  | Failure to comply with appropriate safety guidelines can cause severe injury or property damage. | |
|  | <ul style="list-style-type: none"> • Do not attempt to use this device with parameters that exceed permissible levels. • To avoid damaging the system, do not connect/disconnect the device when power is on. | |

Environmental Considerations



- Do not install in areas with: excessive or conductive dust, corrosive or flammable gas, moisture or rain, excessive heat, regular impact shocks or excessive vibration, in accordance with the standards given in the product's technical specification sheet.
- Do not place in water or let water leak onto the unit.
- Do not allow debris to fall inside the unit during installation.



- Ventilation: 10mm space required between controller's top/bottom edges & enclosure walls.
- Install at maximum distance from high-voltage cables and power equipment.

Mounting

Dimensions

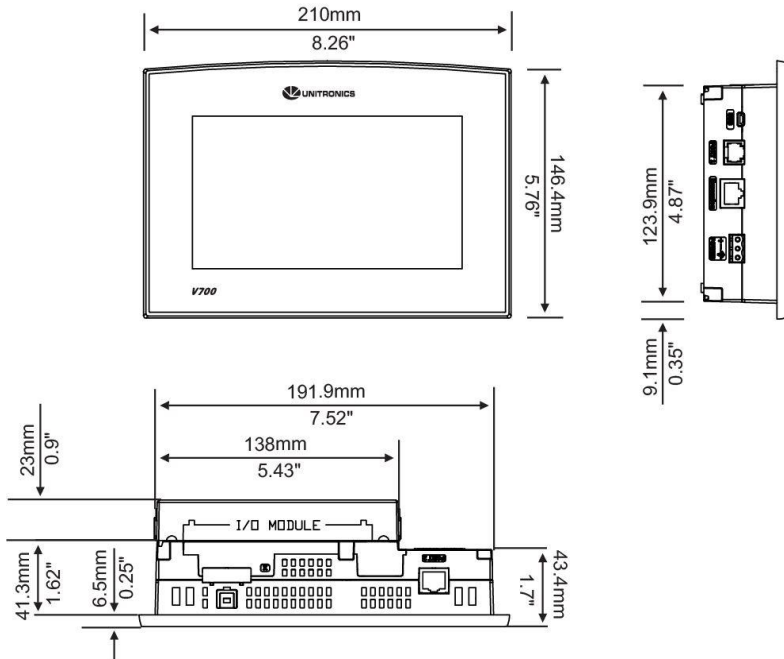

Note that the Snap-in I/O module thickness is 23 mm (0.9").

Panel Mounting

Before you begin, note that the mounting panel cannot be more than 5 mm thick.

1. Make a panel cut-out of the appropriate size:
193x125mm (7.59"x4.92").
2. Slide the controller into the cut-out, ensuring that the rubber seal is in place.
3. Push the mounting brackets into their slots on the sides of the panel as shown in the figure below.
4. Tighten the bracket's screws against the panel. Hold the bracket securely against the unit while tightening the screw.
5. When properly mounted, the controller is squarely situated in the panel cut-out as shown in the accompanying figures.

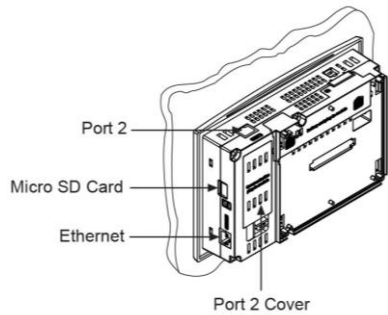
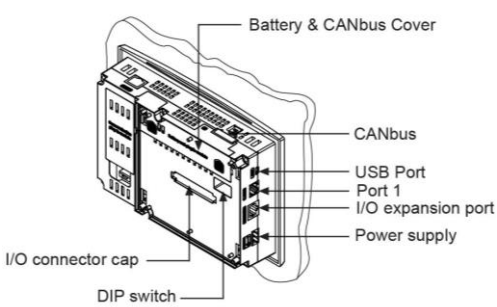
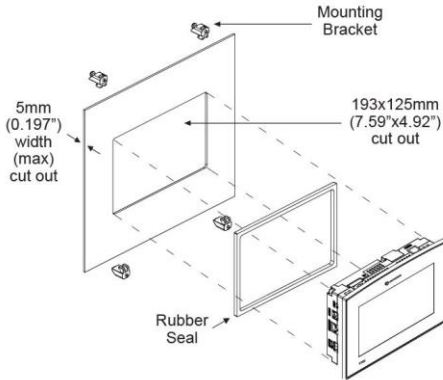

Inserting the Battery

In order to preserve data in case of power-off, you must insert the battery.

The battery is supplied taped to the battery cover on the rear of the controller.

1. Remove the battery cover shown on page 3.
The polarity (+) is marked on the battery holder and on the battery.
2. Insert the battery, ensuring that the polarity symbol on the battery is:
 - facing up
 - aligned with the symbol on the holder
3. Replace the battery cover.



- Use proper precautions to prevent Electro-Static Discharge (ESD) while servicing the battery.

Caution

- To preserve back-up values for RTC and system data during battery replacement, the controller must be powered.
-

Wiring



- Do not touch live wires.



- Install an external circuit breaker. Guard against short-circuiting in external wiring.
- Use appropriate circuit protection devices.
- Unused pins should not be connected. Ignoring this directive may damage the device.
- Double-check all wiring before turning on the power supply.

Caution

- To avoid damaging the wire, do not exceed a maximum torque of 0.5 N·m (5 kgf·cm).
 - Do not use tin, solder, or any substance on stripped wire that might cause the wire strand to break.
 - Install at maximum distance from high-voltage cables and power equipment.
-

Wiring Procedure

Use crimp terminals for wiring; use 3.31 mm²–0.13 mm² wire (12-16 AWG):

1. Strip the wire to a length of 7±0.5mm (0.270–0.300”).
 2. Unscrew the terminal to its widest position before inserting a wire.
 3. Insert the wire completely into the terminal to ensure a proper connection.
 4. Tighten enough to keep the wire from pulling free.
- Input or output cables should not be run through the same multi-core cable or share the same wire.
 - Allow for voltage drop and noise interference with I/O lines used over an extended distance.
Use wire that is properly sized for the load.
 - The controller and I/O signals must be connected to the same 0V signal.

Power Supply

The controller requires either an external 12 or 24VDC power supply.

Note: Photo is for illustration purposes only.



1. The power supply must include double insulation. Outputs must be rated as SELV/PELV/Class 2/Limited Power.

2. Use separate wires to connect the functional earth terminal and the 0V terminal to the system earth ground.

3. Install an external circuit breaker. Guard against short-circuiting in external wiring.



4. Double-check all wiring before turning on the power supply.
5. Do not connect either the 'Neutral' or 'Line' signal of the 110/220VAC to device's 0V pin.
6. In the event of voltage fluctuations or non-conformity to voltage power supply specifications, connect the device to a regulated power supply.

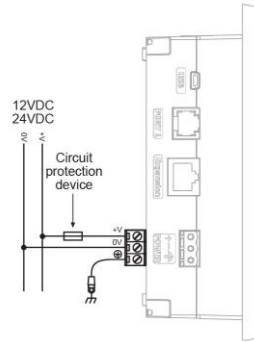

Earthing the PLC+HMI

To maximize system performance, avoid electromagnetic interference by:

- Mounting the controller on a metal panel.
- Connect each common and ground connection directly to the earth ground of your system.

For ground wiring use the shortest and thickest possible wire.

Communication Ports

The controller comprises a USB port, 1 RS232/RS485 serial port and an Ethernet port.

The user may order and install one or both of the following modules:

- An additional port (Port 2).
Available types: RS232/RS485 isolated/non-isolated
- A CANbus port

For the most updated information regarding ports and their installation, please refer to the Technical Library at www.unitronics.com.



- Turn off power before making communications connections.

Caution • Always use the appropriate port adapters.

The USB port may be used for programming, OS download, and PC access.

Note that **COM port 1 function is suspended when this port is physically connected to a PC.**

The serial port type is RJ-11 and may be set to either RS232 or RS485 via DIP switch, in accordance with the table shown below.

Use RS232 to download programs from a PC, and to communicate with serial devices and applications, such as SCADA.

Use RS485 to create a multi-drop network containing up to 32 devices.

Pinouts

The pinouts below show PLC port signals.

To connect a PC to a port that is set to RS485, remove the RS485 connector, and connect the PC to the PLC via the programming cable. Note that this is possible only if flow control signals are not used (which is the standard case).

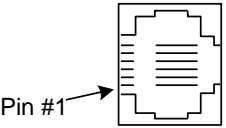
| RS232 | | RS485** | | Controller Port |
|-------|--------------|---------|----------------|--|
| Pin # | Description | Pin # | Description | |
| 1* | DTR signal | 1 | A signal (+) |  |
| 2 | 0V reference | 2 | (RS232 signal) | |
| 3 | TXD signal | 3 | (RS232 signal) | |
| 4 | RXD signal | 4 | (RS232 signal) | |
| 5 | 0V reference | 5 | (RS232 signal) | |
| 6* | DSR signal | 6 | B signal (-) | |

*Standard programming cables do not provide connection points for pins 1 and 6.

**When a port is adapted to RS485, Pin 1 (DTR) is used for signal A, and Pin 6 (DSR) signal is used for signal B.

RS232 to RS485: Changing DIP Switch Settings

The port set to RS232 by factory default.

To change the settings, first remove the Snap-in I/O Module, if one is installed, and then set the switches according to the following table.

RS232/RS485: DIP Switch Settings

| | Switch Settings | | | | | |
|--------------------------|-----------------|-----|-----|-----|-----|-----|
| | 1 | 2 | 3 | 4 | 5 | 6 |
| RS232* | ON | ON | ON | OFF | ON | OFF |
| RS485 | OFF | OFF | OFF | ON | OFF | ON |
| RS485 with termination** | ON | ON | OFF | ON | OFF | ON |

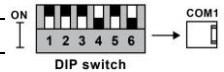

*Default factory setting

**Causes the unit to function as an end unit in an RS485 network

Ethernet

Implement communications via TCP/IP, such as MODBUS over TCP.

RJ45 Connector Pinout

| Pin # | Description |
|-------|-------------------------------|
| 1 | T+ = Positive transmit signal |
| 2 | T- = Negative transmit signal |
| 3 | R+ = Positive receive signal |
| 6 | R- = Negative receive signal |

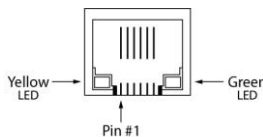

Ethernet LEDs

| LED | Function |
|--------------|---------------------|
| Green (LNK) | ON when link exists |
| Yellow (ACT) | Blinks during RX/TX |

Installing a Snap-in I/O Module

1. Remove the I/O connector cap shown on Page 3.
2. Line the circular guidelines on the Snap-in I/O Module with the slots on the controller as shown below.
3. Apply even pressure on all 4 corners until you hear a distinct 'click'. The module is now installed. Check that all sides and corners are correctly aligned.

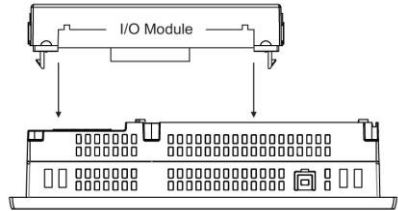
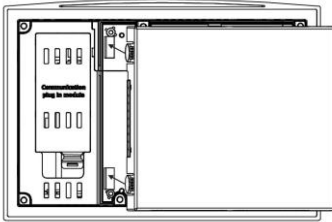

Removing a Snap-in I/O Module

1. Locate the four buttons on the sides of the controller, two on either side.
2. Press the buttons and hold them down to open the locking mechanism.
3. Gently rock the module from side to side, easing the module from the controller.

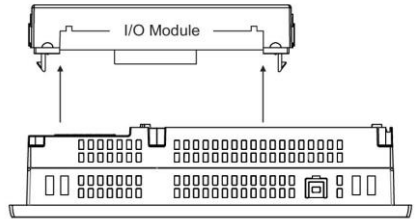
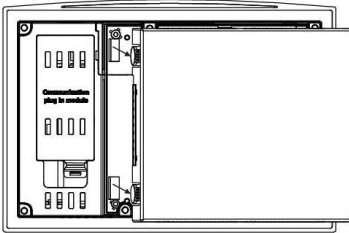

The information in this document reflects products at the date of printing. Unitronics reserves the right, subject to all applicable laws, at any time, at its sole discretion, and without notice, to discontinue or change the features, designs, materials and other specifications of its products, and to either permanently or temporarily withdraw any of the forgoing from the market.

All information in this document is provided "as is" without warranty of any kind, either expressed or implied, including but not limited to any implied warranties of merchantability, fitness for a particular purpose, or non-infringement. Unitronics assumes no responsibility for errors or omissions in the information presented in this document. In no event shall Unitronics be liable for any special, incidental, indirect or consequential damages of any kind, or any damages whatsoever arising out of or in connection with the use or performance of this information.

The tradenames, trademarks, logos and service marks presented in this document, including their design, are the property of Unitronics (1989) (R'G) Ltd. or other third parties and you are not permitted to use them without the prior written consent of Unitronics or such third party as may own them

DOC18001-C9 07/17