

PICMG 1.3 Passive Backplane

Selection Guide

PAC series wall-mount Chassis

4U/5U Rack-mount Chassis

1U/2U Rack-mount Chassis

Art. No.		123603	125821	119944	119106	115851	119648	120748	121501	118009	118600	121622	118010	119320
PICMG1.3 (PCIe+PCI)	Model	PE-2SD1	PE-2SD2	PE-4S	PE-4S2	PE-4S3	PE-5S	PE-5S2	PE-6S	PE-6S2	PE-6S3	PE-6SD	PE-6SD2	PE-6SD3
Total Slot		2	2	4	4	4	5	5	6	6	6	5	5	5
Expansion Slots	PCIe Slots	x16 *	1	1	1	1	1	1	1	1	1	1	1	1
		x4			1	1	1	1	1	1	1	1	1	1
	PCI-X Slots	x1						1	3	2		3	3	2
		PCI Slots		1	1	2		2		2	3	1		1
USB Connectors by Pin Header		4	4	4	4	4	4	4	4	4	4	4	4	4
PSU TYPE		24+4 PIN ATX	24+4 PIN ATX	24+4 PIN ATX	24+4 PIN ATX	24+4 PIN ATX	24+4 PIN ATX	24+4 PIN ATX	24+4 PIN ATX	24+4 PIN ATX	24+4 PIN ATX	24+4 PIN ATX	24+4 PIN ATX	24+4 PIN ATX
Chassis		RACK-1150-PE RACP-1151-PE	RACK-1150-PE RACP-1151-PE	PAC-42GF	PAC-42GF	PAC-42GF	RACK-500G	RACK-500G	RACK-305G RACK-360G RACK-814G RACK-3000G PAC-1700G PAC-125	PAC-106G x1 PAC-107G x1 PAC-1000G	PAC-106G x1 PAC-107G x1 PAC-1000G	RACK-221G RACK-2100G	RACK-221G RACK-2100G	RACK-221G RACK-2100G
Note		1U Type	1U Type									2U Type	2U Type	2U Type

Art. No.		118012	117043	119107	119649	120079	118008	119108	119175	120747	126899	120276	119640
PICMG1.3 (PCIe+PCI)	Model	PE-7S	PE-7S2	PE-8S	PE-9S	PE-10S	PE-10S2	PE-13SD	PE-16SQ	PXE-12S	PXE-13S	PXE-19S	PXE-19S2
Total Slot		7	7	8	9	10	10	13	16	12	13	19	19
Expansion Slots	PCIe Slots	x16 *	1	1	1	1	1	1/1	1/1/1/1	1	1	1	1
		x4											
	PCI-X Slots	x1	2	4	3	4	4	4	0/4	0		3	1
		PCI Slots									6		
USB Connectors by Pin Header		4	4	4	4	4	4	8	4/4/4/4	4	4	4	4
PSU TYPE		24+4 PIN ATX	24+4 PIN ATX	24+4 PIN ATX	24+4 PIN ATX	24+4 PIN ATX	24+4 PIN ATX	Dual 24+4 PIN ATX	Three 20+4 Pin ATX One 24+4-pin ATX	24+4 PIN ATX	24+4 PIN ATX	24+4 PIN ATX	24+4 PIN ATX
Chassis		PAC-1700G	PAC-1700G	PAC-125G	N/A	RACK-305G RACK-360G RACK-814G RACK-3000G	RACK-3000G RACK-305G RACK-360G RACK-814G	RACK-3000G RACK-305G RACK-360G RACK-814G-R20	N/A	RACK-3000G RACK-305G RACK-360G RACK-814G	RACK-3000G RACK-305G RACK-360G RACK-814G	RACK-3200G RACK-3035G	RACK-3200G RACK-3035G
Note								Dual System Backplane	Quad System Backplane	PCIe to PCI-X Bridge backplane	PCIe to PCI Bridge backplane		

*1: When using a PCIe x16 add-on card, the length of the card must not exceed 167mm or 6.57inches.

IEI Graphic Grade Backplane Solution

Graphic centric backplane targets at applications which concerning system speed and performance. It has higher performance over cost ratio than previous PICMG1.0 solution.

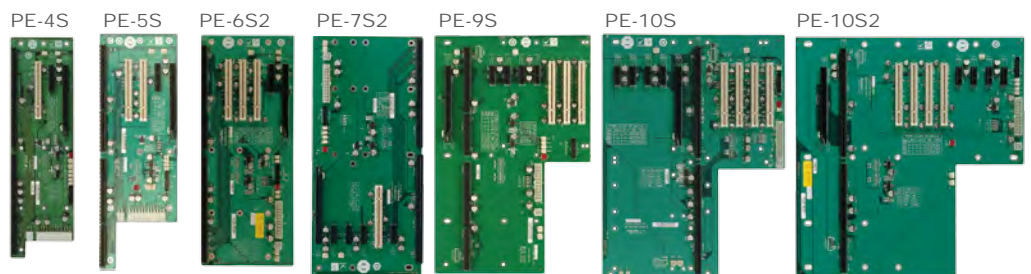
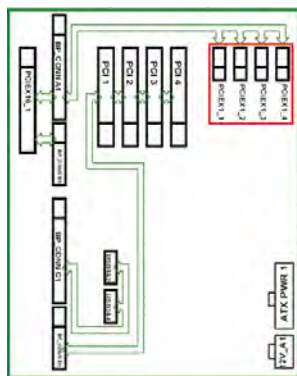

- 20 PCIe Lanes Total
- One PCIe x16 Slot
- Up to four PCIe x1 or One PCIe x4 Slot
- Up to four Local PCI Slots (w/o Bridge)

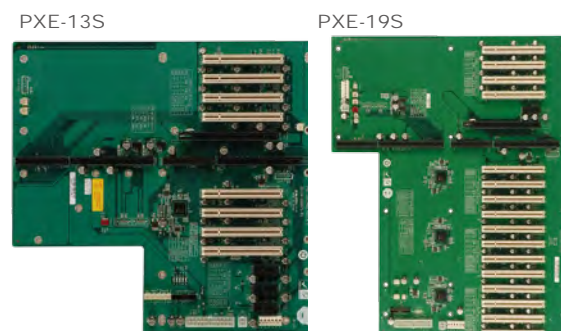
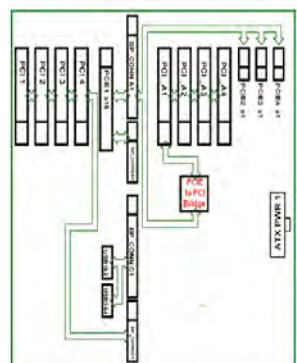

- 20 PCIe Lanes Total
- One PCIe x16 Slot
- Up to Four PCIe x1 Slots
- PCI Slots Expandable via PCIe to PCI Bridge

PE-2SD1-R10

For 1U system!

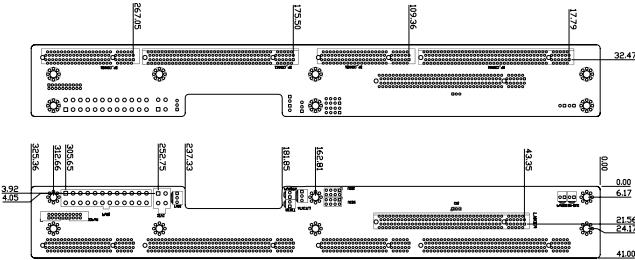

Ordering Information

- PE-2SD1-R10 2-slot backplane with 1 PCIe slot
- RACK-1150G-PE 1U full-size rack-mount chassis
- RACK-1151G-PE 1U full-size rack-mount chassis

PE-2SD2-R10

For 1U system!

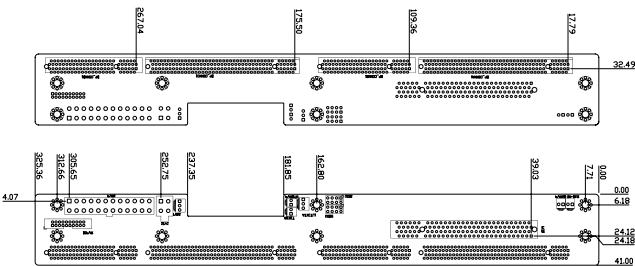

Ordering Information

- PE-2SD2-R10 2-slot backplane with 1 PCI slot
- RACK-1150G-PE 1U full-size rack-mount chassis
- RACK-1151G-PE 1U full-size rack-mount chassis

PE-4S-R40

Mounting holes compatible with PCI-4S

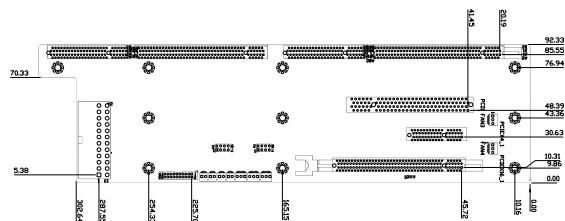

Ordering Information

- PE-4S-R40 4-slot backplane with 1 PCIe x16 slot, 1 PCIe x4 slot and 1 PCI slot
- PAC-42GF 4-slot full-size compact chassis

PE-4S2-R40

Mounting holes compatible with PCI-4S

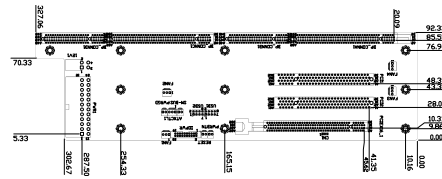

Ordering Information

- PE-4S2-R40 4-slot backplane with 1 PCIe x16 slot and 2 PCI slots
- PAC-42GF 4-slot full-size compact chassis

PE-4S3-R40

Mounting holes compatible with PCI-4S

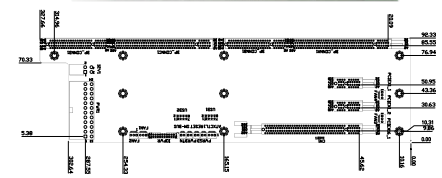

Ordering Information

- PE-4S3-R40 4-slot backplane with 1 PCIe x16 slot and 2 PCIe x1 slots.
- PAC-42GF 4-slot full-size compact chassis

PE-5S-R40

Mounting holes compatible with PCI-5S

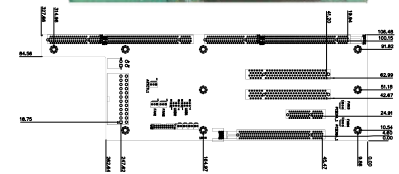

Ordering Information

- PE-5S-R40 5-slot backplane with 1 PCIe x16 slot, 1 PCIe x4 slot and 2 PCI slots
- RACK-500G 5U 5-slot full-size rack-mount chassis

PE-5S2-R40

Mounting holes compatible with PCI-5S

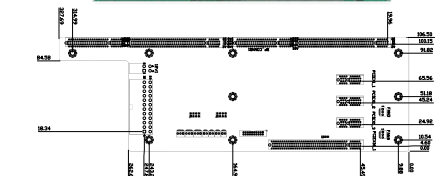

Ordering Information

- PE-5S2-R40 5-slot backplane with 1 PCIe x16 slot and 3 PCIe x1 slots
- RACK-500G 5U 5-slot full-size rack-mount chassis

PE-6S-R41

Mounting holes compatible with PCI-7S

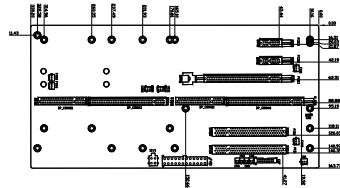

Ordering Information

- PE-6S-R41 6-slot backplane with 1 PCIe x16 slot, 2 PCIe x1 slots and 2 PCI slots
- RACK-305G 4U 14-slot full-size rack-mount chassis
- RACK-360G 4U 14-slot full-size rack-mount chassis
- RACK-814G 4U 14-slot full-size rack-mount chassis
- RACK-3000G 4U 14-slot full-size rack-mount chassis
- PAC-1700G 7-slot full-size compact chassis
- PAC-125G 10-slot full-size compact chassis

PE-6S2-R40

Mounting holes compatible with PCI-6S

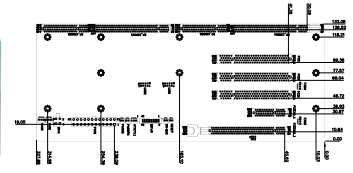

Ordering Information

- PE-6S2-R40 6-slot backplane with 1 PCIe x16 slot, 1 PCIe x4 slot and 3 PCI slots
- PAC-106G ^{*1} 6-slot full-size compact chassis
- PAC-107G ^{*1} 6-slot full-size compact chassis
- PAC-1000G 6-slot full-size compact chassis

^{*1}: When using a PCIe x16 add-on card, the length of the card must not exceed 167mm or 6.57inches.

PE-6S3-R40

Mounting holes compatible with PCI-6S

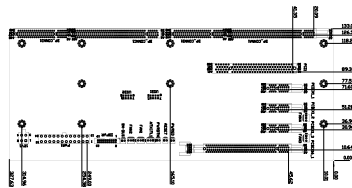

Ordering Information

- PE-6S3-R40 6-slot backplane with 1 PCIe x16 slot, 3 PCIe x1 slots and 1 PCI slot
- PAC-106G ^{*1} 6-slot full-size compact chassis
- PAC-107G ^{*1} 6-slot full-size compact chassis
- PAC-1000G 6-slot full-size compact chassis

^{*1}: When using a PCIe x16 add-on card, the length of the card must not exceed 167mm or 6.57inches.

PE-6SD-R40

Mounting holes compatible with PCI-6SD

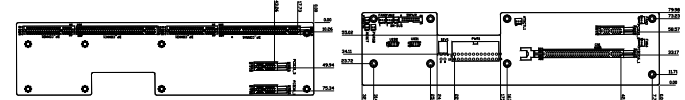
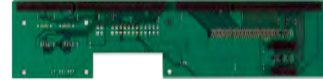

Ordering Information

- PE-6SD-R40 5-slot backplane with 1 PCIe x16 slot and 3 PCIe x1 slots
- RACK-221G 2U 6-slot full-size rack-mount chassis
- RACK-2100G 2U 6-slot full-size rack-mount chassis

PE-6SD2-R40

Mounting holes compatible with PCI-6SD

2U Type

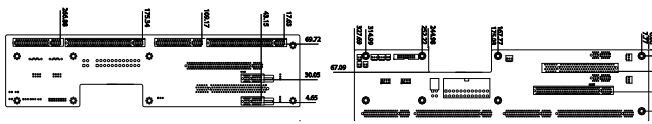
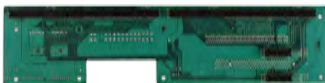

Ordering Information

- PE-6SD2-R40 5-slot backplane with 1 PCIe x16 slot, 2 PCIe x1 slots and 1 PCI slot
- RACK-221G 2U 6-slot full-size rack-mount chassis
- RACK-2100G 2U 6-slot full-size rack-mount chassis

PE-6SD3-R40

Mounting holes compatible with PCI-6SD

2U Type

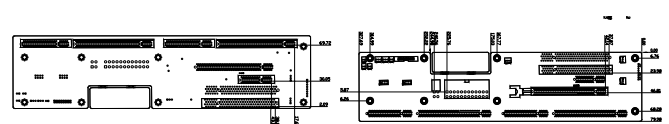

Ordering Information

- PE-6SD3-R40 5-slot backplane with 1 PCIe x16 slot, 1 PCIe x4 slots and 2 PCI slots
- RACK-221G 2U 6-slot full-size rack-mount chassis
- RACK-2100G 2U 6-slot full-size rack-mount chassis

PE-7S-R40

Mounting holes compatible with PCI-7S

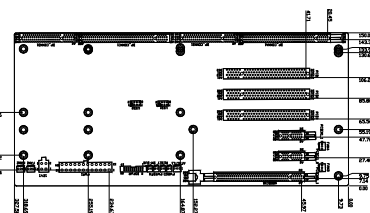

Ordering Information

- PE-7S-R40 7-slot backplane with 1 PCIe x16 slot, 2 PCIe x1 slots and 3 PCI slots
- PAC-1700G 7-slot full-size compact chassis

PE-7S2-R40

Mounting holes compatible with PCI-7S

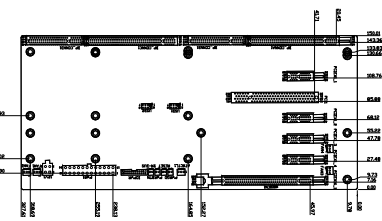

Ordering Information

- PE-7S2-R40 7-slot backplane with 1 PCIe x16 slot and 4 PCIe x1 slots and 1 PCI slot
- PAC-1700G 7-slot full-size compact chassis

PE-8S-R40

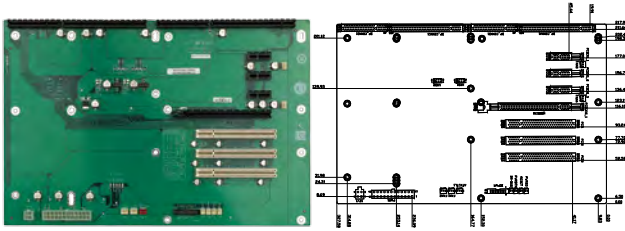

Ordering Information

- PE-8S-R40 8-slot backplane with 1 PCIe x16 slots, 3 PCIe x1 slots and 3 PCI slots
- PAC-125G 10-slot full-size compact chassis

PE-9S-R40

Mounting holes compatible with PCI-10S2

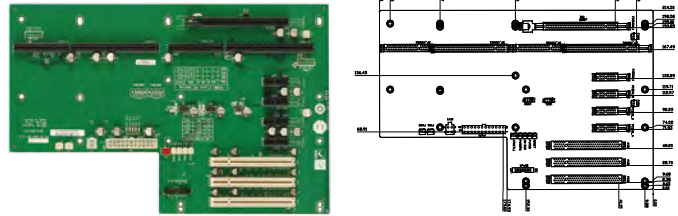

Ordering Information

- PE-9S-R40 9-slot backplane with 1 PCIe x16 slot, 4 PCIe x1 slots and 3 PCI slots

PE-10S-R40

Mounting holes compatible with PCI-14S

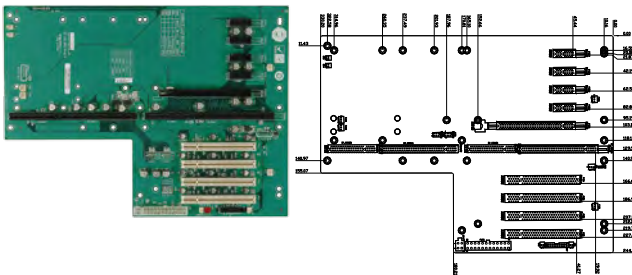

Ordering Information

- PE-10S-R40 10-slot backplane with 1 PCIe x16 slots, 4 PCIe x1 slots and 4 PCI slots
- RACK-305G 4U 14-slot full-size rack-mount chassis
- RACK-360G 4U 14-slot full-size rack-mount chassis
- RACK-814G 4U 14-slot full-size rack-mount chassis
- RACK-3000G 4U 14-slot full-size rack-mount chassis

PE-10S2-R40

Mounting holes compatible with PCI-14S

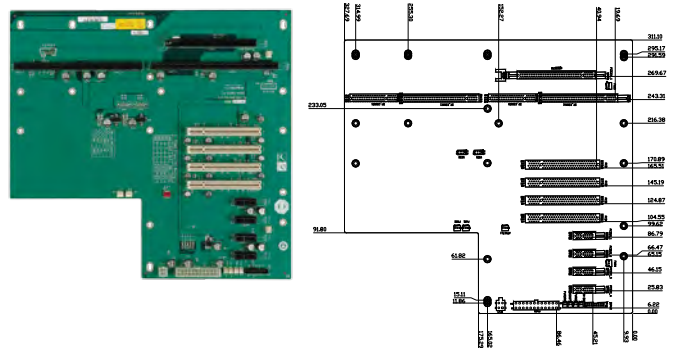

Ordering Information

- PE-10S2-R40 10-slot backplane with 1 PCIe x16 slot, 4 PCIe x1 slot and 4 PCI slots
- RACK-3000G 4U 14-slot full-size rack-mount chassis
- RACK-305G0 4U 14-slot full-size rack-mount chassis
- RACK-360G 4U 14-slot full-size rack-mount chassis
- RACK-814G 4U 14-slot full-size rack-mount chassis

PE-13SD-R40

Mounting holes compatible with PCI-14S

Dual system

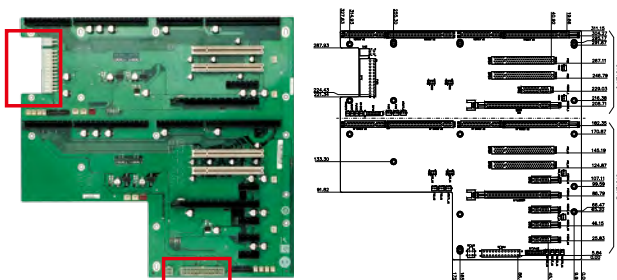

2 independent power resources

Ordering Information

- PE-13SD-R40 13 Slots Backplane with 2 PCIe x 16 and 1 PCIe x 4 and 4 PCIe x 1 and 4 PCI slot.
- RACK-3000G 4U 14-slot full-size rack-mount chassis
- RACK-305G 4U 14-slot full-size rack-mount chassis
- RACK-360G 4U 14-slot full-size rack-mount chassis
- RACK-814G 4U 14-slot full-size rack-mount chassis

PE-16SQ-R10

Mounting holes compatible with PCI-18SQ

Quad system

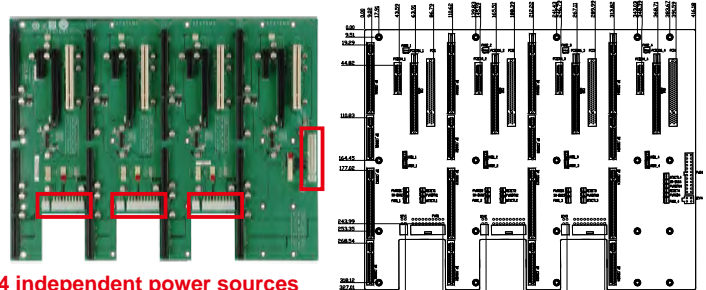

4 independent power sources

Ordering Information

- PE-16SQ-R10 4-system backplane with each system having 1 PCIe x16 slot, 1 PCIe x4 slot and 1 PCI slot

PXE-12S-R10

Mounting holes compatible with PCI-14S

(PCIe to PCI-X Bridge)

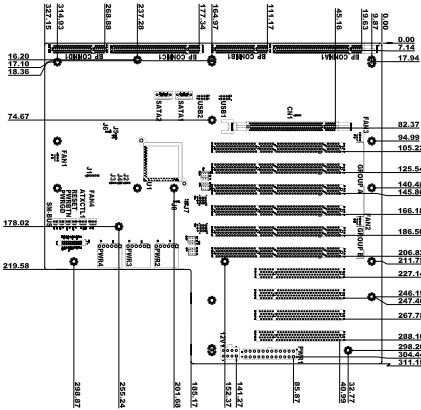

Ordering Information

- PXE-12S-R10 12-slot backplane with 1 PCIe x16 slot, 6 PCI-X slots and 4 PCI slots
- RACK-3000G 4U 14-slot full-size rack-mount chassis
- RACK-305G 4U 14-slot full-size rack-mount chassis
- RACK-360G 4U 14-slot full-size rack-mount chassis
- RACK-814G 4U 14-slot full-size rack-mount chassis

PXE-19S-R40

Mounting holes compatible with PCI-19S

(PCIe to PCI Bridge)

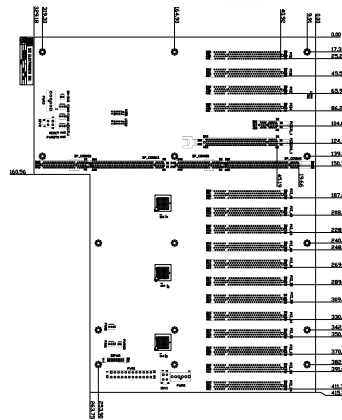
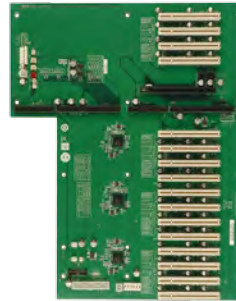

Ordering Information

- PXE-19S-R40 19-slot backplane with 1 PCIe x16 slot, 1 PCIe x1 slot and 16 PCI slots
- RACK-3200G 4U 20-slot full-size rack-mount chassis
- RACK-3035G 7U 20-slot full-size rack-mount chassis

PXE-13S-R42

Mounting holes compatible with PCI-14S

(PCIe to PCI-X Bridge)

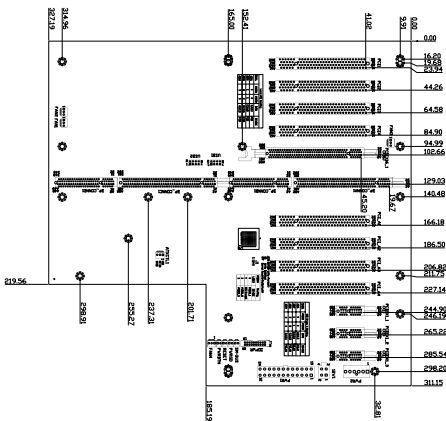
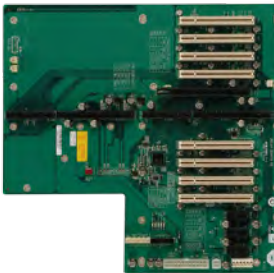

Ordering Information

- PXE-13S-R42 13-slot backplane with 1 PCIe x16 slot, 3 PCIe x1 slots and 8 PCI slots
- RACK-3000G 4U 14-slot full-size rack-mount chassis
- RACK-305G 4U 14-slot full-size rack-mount chassis
- RACK-360G 4U 14-slot full-size rack-mount chassis
- RACK-814G 4U 14-slot full-size rack-mount chassis

PXE-19S2-R10

Mounting holes compatible with PCI-19S

(PCIe to PCI Bridge)

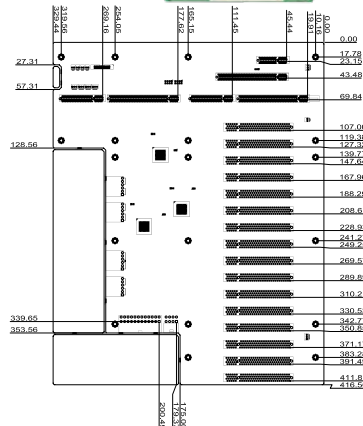

Ordering Information

- PXE-19S2-R10 19-slot backplane with 1 PCIe x16 slot, 1 PCIe x1 slot and 16 PCI slots
- RACK-3200G 4U 20-slot full-size rack-mount chassis
- RACK-3035G 7U 20-slot full-size rack-mount chassis