

# Quick Start

## for PCIe-S118 PCIe-S148



June, 2021/ Version 1.1

# 1

## What's in the Shipping Package?

The package includes the following items:

- 1 PCIe-S118 or PCIe-S148



- 2 Quick Start Guide (This Guide)



- 3 Software CD (V6.1 or later)



- 4 CA-PC62M Connector



# 2

## Installing Windows Driver

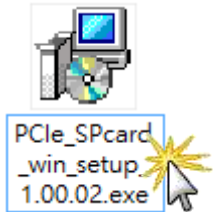

- 1 Launch the **Windows XP/7/8/10/2012/2016 (32/64-bit) driver setup program (PCIe\_SPCard\_Win\_Setup\_1.00.02.exe)**, which can be obtained from either the companion CD-ROM or the web site:

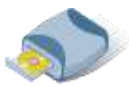

CD: \Napdos\multiport\windows\



<https://www.icpdas.com/en/download/index.php?nation=US&kw=PCIe+Series+Card+Windows+Driver>

- 2 Click the **“Next>”** button to start the installation.
- 3 Click the **“Next>”** button to install the driver into the default folder.
- 4 In the installation process, the Command Prompt windows will be displayed, don't care. And please do not close this Command Prompt window in installation process.
- 5 Select the **“NO, I will restart the computer later”** and click the **“Finish”** button.

# 3

## Installing the Hardware

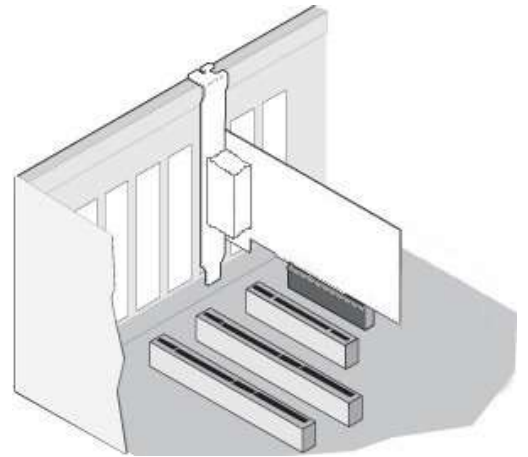

- ❶ Shut down and power off your computer.
- ❷ Remove the cover from the computer.
- ❸ Select an unused PCI Express slot.
- ❹ Carefully insert your PCIe-S1x8 card into the PCI Express slot.
- ❺ Replace the PC cover.
- ❻ Power on the computer.
- ❼ Follow the prompt message to finish the Plug & Play steps.
- ❽ Please open the **“Device Manager”** to verify the COM port installation, as follows steps:

8-1: In Windows 7, Click **“Start”** button, and then click **“Control Panel”**.

8-2: Click **“System and Maintenance”**, and then click **“Device Manager”**.

8-3: Verify that the COM ports of PCIe-S118/S148 card are listed correctly.

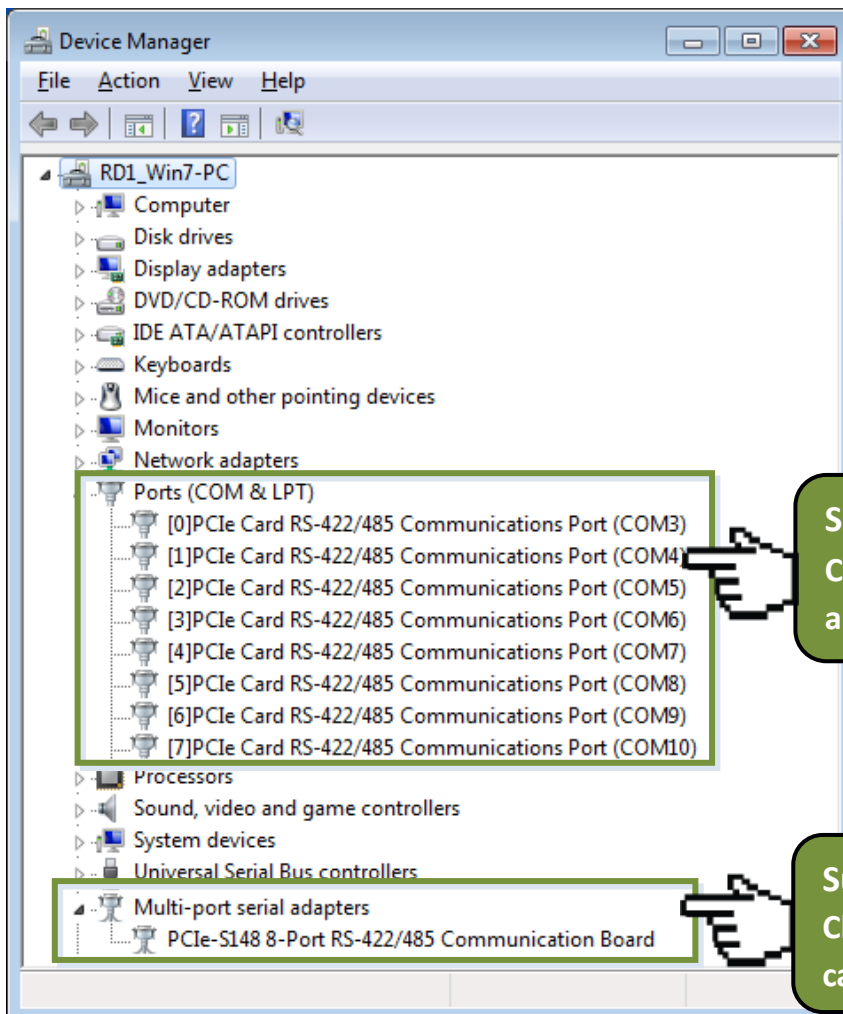

**Successful Installation**  
COM port mapping is automatically applied depending on the PC.

**Successful Installation**  
Check whether the PCIe-S1x8 card is listed correctly or not.

# 4

## Manual COM Port Configuration

If the auto-configuration for COM Port is messy or that is not you need, you can change the COM port mappings. For detailed configuration steps, please refer to the following:

- ❶ Open Windows **Device Manager** and **right click** on the serial port of the PCIe-S1x8 series card.
- ❷ Select the **“Properties”** item from the popup menu.
- ❸ Click the **“Port Settings”** tab and click the **“Advanced...”** button.
- ❹ Select the appropriate **COM Port number** from the **“COM Port Number:”** drop-down options and click the **“OK”** button. **Note that the COM port display “(in use)” means this COM port is being used. Therefore, please do not select it.**
- ❺ Click the **“OK”** button in the “Properties” dialog box.
- ❻ **Restart your computer** to complete the configuration.

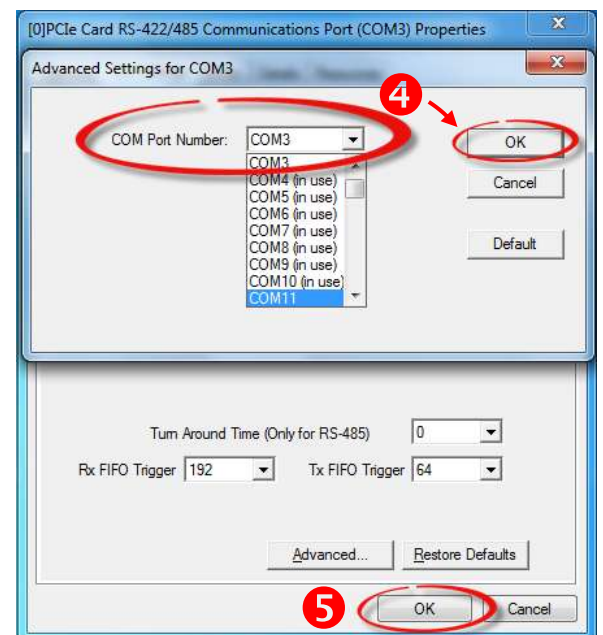
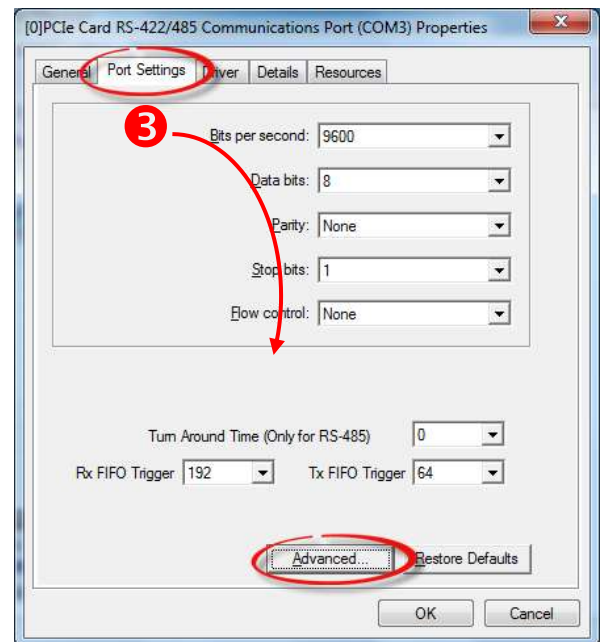
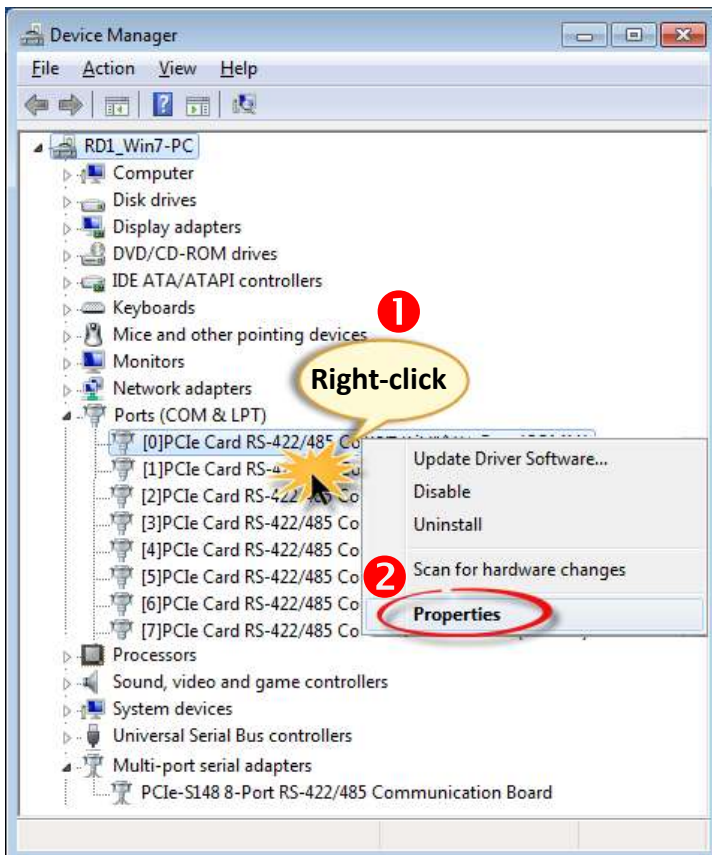

# 5

## Pin Assignments and RS-232 Cable Wiring for PCIe-S118

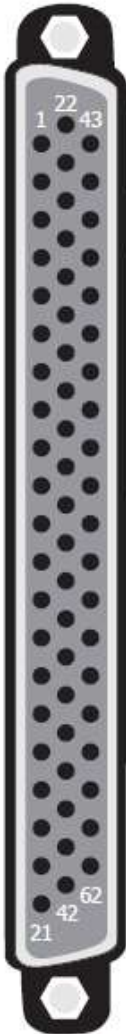

Terminal No.	Pin Assignment	Terminal No.	Pin Assignment	Terminal No.	Pin Assignment
01	TxD_0	22	RxD_0	43	CTS_0
02	DTR_0	23	DSR_0	44	RTS_0
03	RxD_1	24	DCD_0	45	GND
04	DSR_1	25	TxD_1	46	CTS_1
05	DCD_1	26	DTR_1	47	RTS_1
06	TxD_2	27	RxD_2	48	CTS_2
07	DTR_2	28	DSR_2	49	RTS_2
08	RxD_3	29	DCD_2	50	GND
09	DSR_3	30	TxD_3	51	CTS_3
10	DCD_3	31	DTR_3	52	RTS_3
11	RxD_4	32	GND	53	CTS_4
12	DSR_4	33	TxD_4	54	RTS_4
13	DCD_4	34	DTR_4	55	GND
14	TxD_5	35	RxD_5	56	CTS_5
15	DTR_5	36	DSR_5	57	RTS_5
16	RxD_6	37	DCD_5	58	GND
17	DSR_6	38	TxD_6	59	CTS_6
18	DCD_6	39	DTR_6	60	RTS_6
19	RxD_7	40	GND	61	CTS_7
20	DSR_7	41	TxD_7	62	RTS_7
21	DCD_7	42	DTR_7		

CON1

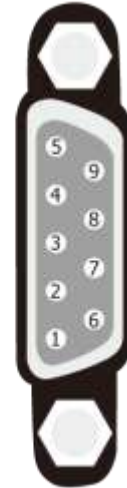

Terminal No.	Pin Assignment
01	DCD
02	RxD
03	TxD
04	DTR
05	GND
06	DSR
07	RTS
08	CTS
09	-

Female DB-62 to Male DB-9 Connector

PCIe-S118 Card		RS-232 Wiring		Device	
Signal	PIN		PIN	Signal	
RxD	2	←	3	TxD	
TxD	3	→	2	RxD	
GND	5	↔	5	GND	
DTR	4	→	6	DSR	
--	--		1	DCD	
DCD	1	←	--	--	
DSR	6	←	4	DTR	
RTS	7	→	8	CTS	
CTS	8	←	7	RTS	

# 6

## Pin Assignments and RS-422/485 Cable Wiring for PCIe-S148



Terminal No.	Pin Assignment	Terminal No.	Pin Assignment	Terminal No.	Pin Assignment
01	RxD0+	22	TxD0+/Data0+	43	-
02	RxD0-	23	-	44	-
03	TxD1+/Data1+	24	TxD0-/Data0-	45	GND
04	-	25	RxD1+	46	-
05	TxD1-/Data1-	26	RxD1-	47	-
06	RxD2+	27	TxD2+/Data2+	48	-
07	RxD2-	28	-	49	-
08	TxD3+/Data3+	29	TxD2-/Data2-	50	GND
09	-	30	RxD3+	51	-
10	TxD3-/Data3-	31	RxD3-	52	-
11	TxD4+/Data4+	32	GND	53	-
12	-	33	RxD4+	54	-
13	TxD4-/Data4-	34	RxD4-	55	GND
14	RxD5+	35	TxD5+/Data5+	56	-
15	RxD5-	36	-	57	-
16	TxD6+/Data6+	37	TxD5-/Data5-	58	GND
17	-	38	RxD6+	59	-
18	TxD6-/Data6-	39	RxD6-	60	-
19	TxD7+/Data7+	40	GND	61	-
20	-	41	RxD7+	62	-
21	TxD7-/Data7-	42	RxD7-		

CON1



Terminal No.	Pin Assignment
01	TxD-/Data-
02	TxD+/Data+
03	RxD+
04	RxD-
05	GND
06	-
07	-
08	-
09	-

Female DB-62 to Male DB-9 Connector

PCIe-S148 Card		RS-485 Wiring		Device	
Signal	PIN		PIN	Signal	
DATA-	1	↔	1	DATA-	
DATA+	2	↔	2	DATA+	

**Note:** The RS-485 bus is a differential (balanced) signal, thus you cannot wire the Data+ with Data- directly for a single port loop-back test. It will not work at all.

PCIe-S148 Card		RS-422 Wiring		Device	
Signal	PIN		PIN	Signal	
TxD-	1	→	4	RxD-	
TxD+	2	→	3	RxD+	
RxD+	3	←	2	TxD+	
RxD-	4	←	1	TxD-	
GND	5	↔	5	GND	

# 7

## Self-Test Wiring

**Step 1:** Connect the DN-09-2 terminal board (optional) to the PCIe-S1x8 series card using the CA-9-6210 and CA-0910F cables (optional).

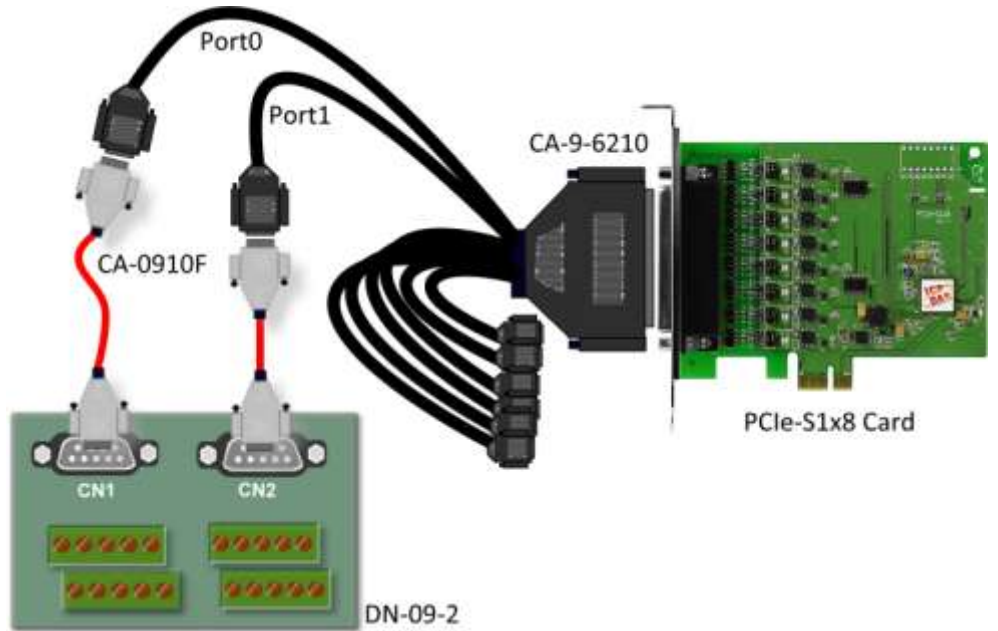

**Step 2:** Wire the Port 0 and Port1.

➤ **PCIe-S118 card (RS-232 Wiring):** Shorting the RxD, TxD and GND pins of both Port0 and Port1.

Port0 Signal	PIN		PIN	Port1 Signal
TxD0	3	↔	2	RxD1
RxD0	2	↔	3	TxD1
GND	5	↔	5	GND

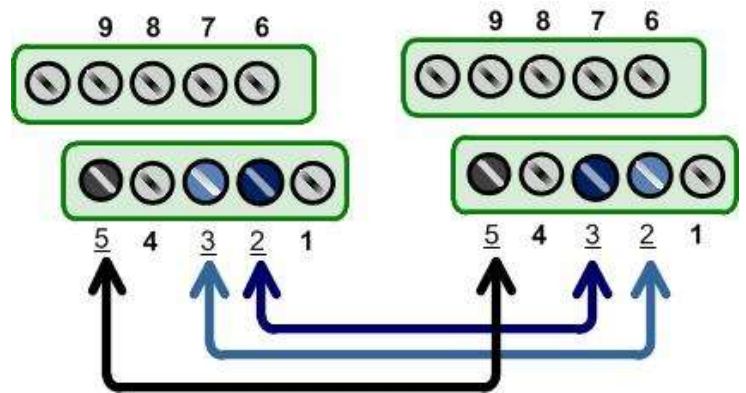

➤ **PCIe-S148 card (RS-485 Wiring):** Shorting the Port0 Data+ and Port1 Data+ and the Port0 Data- and Port1 Data- pins.

Port0 Signal	PIN		PIN	Port1 Signal
Data0-	1	↔	1	Data1-
Data0+	2	↔	2	Data1+

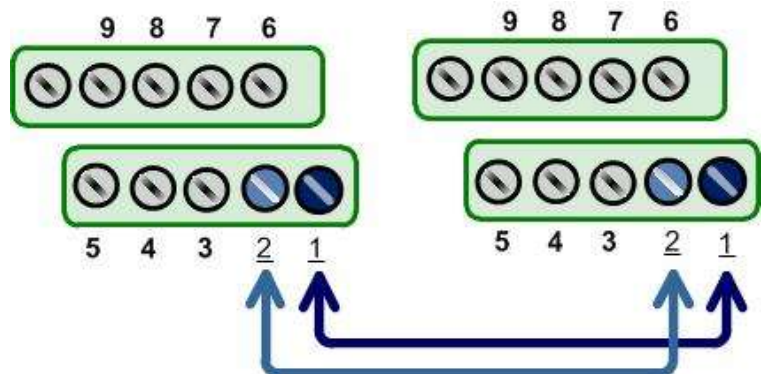

# 8

## Execute the Test Program

**Step 1:** Execute the **Test2COM.exe** program, which can be downloaded from:



CD:\Napdos\multiport\utility



Test2COM.exe



<https://www.icpdas.com/en/download/index.php?nation=US&kw=Test2COM>

**Step 2:** Set the appropriate COM Ports, Baud Rate and Data Format information to the values shown in the image below.

- ❶ COM Ports: Enter **COM3** (First), **COM4** (Second).
- ❷ Data Bits: Check **"8"**
- ❸ Parity: Check **"None"**
- ❹ Stop Bits: Check **"1"**
- ❺ Baud Rates: Check values **9600 to 115200**
- ❻ Test Loops: Type **"1"**
- ❼ Click the **"Start Test"** button to begin the

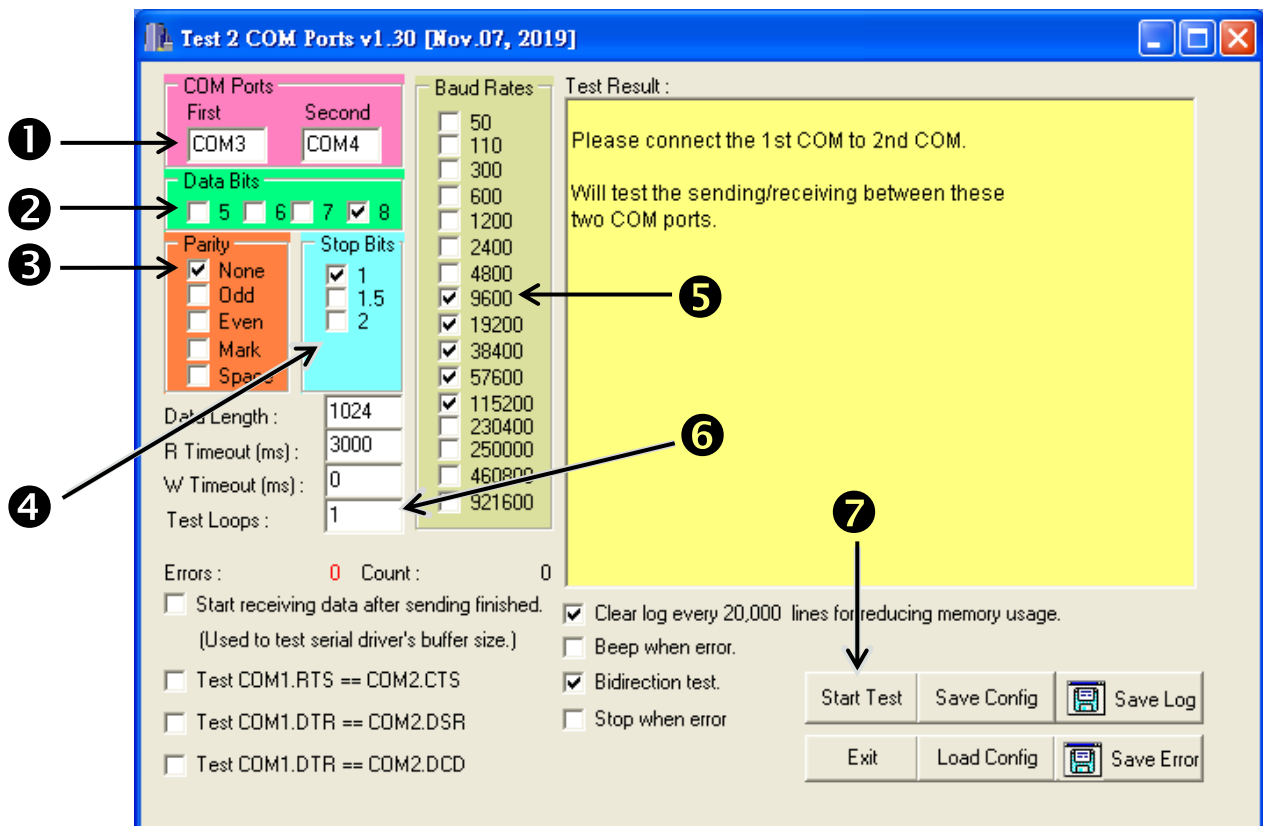

# 9

## Successful Testing

Once the test is complete, verify the test results.

If the result indicates that the test was successful, the expanded COM Port is ready-to-use.

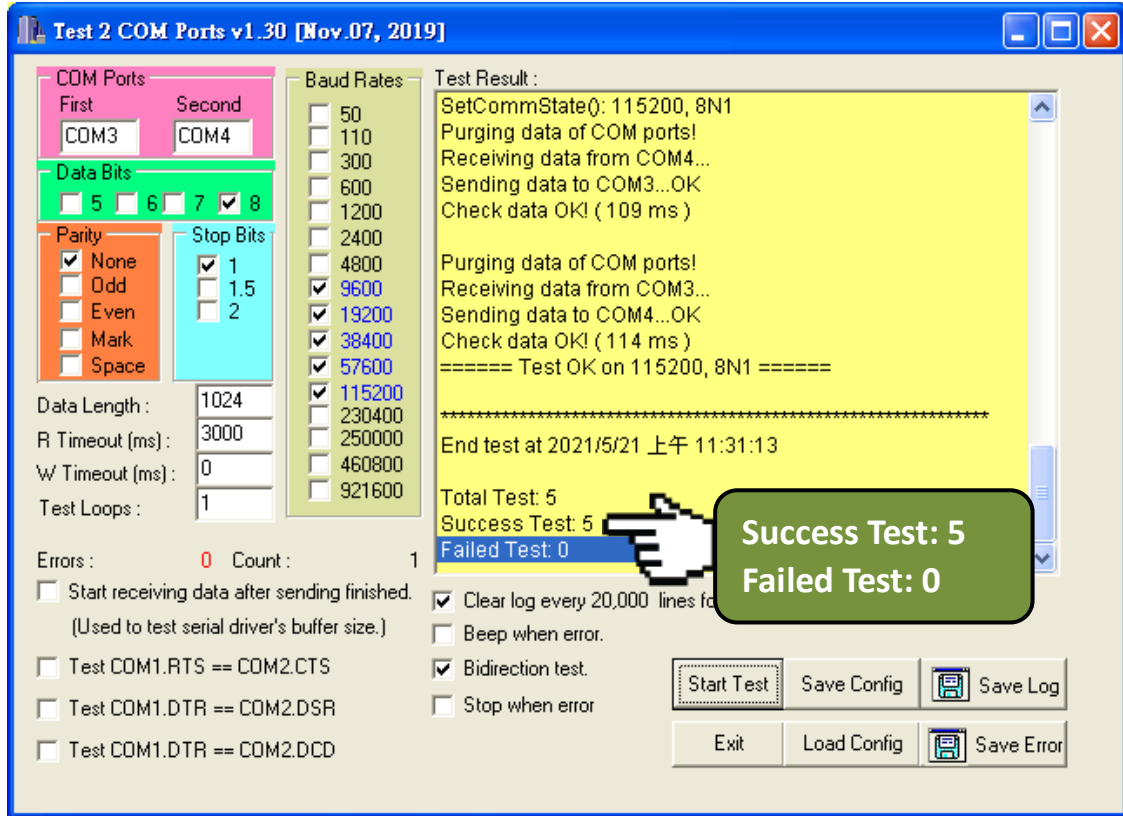

### Related Information

- PCIe-S118/PCIe-S148 card product page:  
<https://www.icpdas.com/en/product/guide+Industrial+Communication+Serial+Communicatio+n+Multi-port+Serial+Board#793>
- DN-09-2, CA-0910F and CA-9-6210 product page (optional):  
<https://www.icpdas.com/en/product/DN-09-2>  
<https://www.icpdas.com/en/product/CA-0910F>  
<https://www.icpdas.com/en/product/CA-9-6210>
- Software and documentation:  
CD: \Napdos\multiport\  
<https://www.icpdas.com/en/download/index.php?model=PCIe-S118>