



NEXCOM International Co., Ltd.

IoT Automation Solutions Business Group

Embedded Computing (3.5" CPU Board)

EBC 357X

User Manual

CONTENTS

Preface

Copyright	iv
Disclaimer	iv
Acknowledgements	iv
Regulatory Compliance Statements	iv
Declaration of Conformity	iv
RoHS Compliance	v
Warranty and RMA	vi
Safety Information	viii
Installation Recommendations	viii
Safety Precautions	ix
Technical Support and Assistance	x
Conventions Used in this Manual	x
Global Service Contact Information	xi
Package Contents	xiii
Ordering Information	xiii

Chapter 1: Product Introduction

Overview	1
Key Features	1
Hardware Specifications	2
Knowing Your EBC 357X	4
Top View	4
Bottom View	5

Chapter 2: Jumpers and Connectors

Before You Begin	6
Precautions	6
Jumper Settings	7
Locations of the Jumpers and Connectors	8
Top View	8
Bottom View	9
Jumpers and DIP Switch Settings	10
AT/ATX Power Type Select	10
RTC Clear Select	10
LCD Power Select	11
PWM/CCFL Select	11
Connector Pin Definitions	12
External I/O Interfaces	12
VGA	12
HDMI Ports	12
Dual USB 3.0 Port A	13
Dual USB 3.0 Port B	13
LAN1 Port	14
LAN2 Port	14
Internal Connectors	15
ATX Power Output Connector	15
Power Button/LED/SMBus/Reset	15
PS/2 Keyboard/Mouse Connector	16



- System Fan Connector 16
- GPIO Connector..... 17
- COM Port 1 (RS232)..... 17
- COM Port 2 (RS232/RS422/RS485) 18
- COM Port 3 (RS232)..... 18
- COM Port 4 (RS232)..... 19
- Mic-in Connector 19
- Line-out Connector 20
- Speaker-out Connector 20
- LVDS Channel A..... 21
- LVDS Channel B 21
- LVDS Panel Inverter Connector 22
- UART Pin Header..... 22
- SIM Card Connector 23
- SATA Connector A 23
- SATA DOM Connector 24
- SATA Power Connector 24
- SATA DOM Power Connector..... 25
- Mini-PCIe Connector (Wi-Fi)..... 26
- M.2 Connector 27
- Block Diagram 28

Chapter 3: BIOS Setup

- About BIOS Setup 29
- When to Configure the BIOS..... 29
- Default Configuration 30
- Entering Setup 30
- Legends 30
- BIOS Setup Utility..... 32
 - Main 32
 - Advanced..... 33

- Chipset..... 54
- Security 71
- Boot 71
- Save & Exit 72

Appendix A: GPI/O Programming Guide.....74

Appendix B: Watchdog Timer Setting.....76

PREFACE

Copyright

This publication, including all photographs, illustrations and software, is protected under international copyright laws, with all rights reserved. No part of this manual may be reproduced, copied, translated or transmitted in any form or by any means without the prior written consent from NEXCOM International Co., Ltd.

Disclaimer

The information in this document is subject to change without prior notice and does not represent commitment from NEXCOM International Co., Ltd. However, users may update their knowledge of any product in use by constantly checking its manual posted on our website: <http://www.nexcom.com>. NEXCOM shall not be liable for direct, indirect, special, incidental, or consequential damages arising out of the use of any product, nor for any infringements upon the rights of third parties, which may result from such use. Any implied warranties of merchantability or fitness for any particular purpose is also disclaimed.

Acknowledgements

EBC 357X is a trademark of NEXCOM International Co., Ltd. All other product names mentioned herein are registered trademarks of their respective owners.

Regulatory Compliance Statements

This section provides the FCC compliance statement for Class A devices and describes how to keep the system CE compliant.

Declaration of Conformity

FCC

This equipment has been tested and verified to comply with the limits for a Class A digital device, pursuant to Part 15 of FCC Rules. These limits are designed to provide reasonable protection against harmful interference when the equipment is operated in a commercial environment. This equipment generates, uses, and can radiate radio frequency energy and, if not installed and used in accordance with the instructions, may cause harmful interference to radio communications. Operation of this equipment in a residential area (domestic environment) is likely to cause harmful interference, in which case the user will be required to correct the interference (take adequate measures) at their own expense.

CE

The product(s) described in this manual complies with all applicable European Union (CE) directives if it has a CE marking. For computer systems to remain CE compliant, only CE-compliant parts may be used. Maintaining CE compliance also requires proper cable and cabling techniques.

RoHS Compliance



NEXCOM RoHS Environmental Policy and Status Update

NEXCOM is a global citizen for building the digital infrastructure. We are committed to providing green products and services, which are compliant with European Union RoHS (Restriction on Use of Hazardous Substance in Electronic Equipment) directive 2011/65/EU, to be your trusted green partner and to protect our environment.

RoHS restricts the use of Lead (Pb) < 0.1% or 1,000ppm, Mercury (Hg) < 0.1% or 1,000ppm, Cadmium (Cd) < 0.01% or 100ppm, Hexavalent Chromium (Cr6+) < 0.1% or 1,000ppm, Polybrominated biphenyls (PBB) < 0.1% or 1,000ppm, and Polybrominated diphenyl Ethers (PBDE) < 0.1% or 1,000ppm.

In order to meet the RoHS compliant directives, NEXCOM has established an engineering and manufacturing task force in to implement the introduction of green products. The task force will ensure that we follow the standard NEXCOM development procedure and that all the new RoHS components and new manufacturing processes maintain the highest industry quality levels for which NEXCOM are renowned.

The model selection criteria will be based on market demand. Vendors and suppliers will ensure that all designed components will be RoHS compliant.

How to recognize NEXCOM RoHS Products?

For existing products where there are non-RoHS and RoHS versions, the suffix "(LF)" will be added to the compliant product name.

All new product models launched after January 2013 will be RoHS compliant. They will use the usual NEXCOM naming convention.

Warranty and RMA

NEXCOM Warranty Period

NEXCOM manufactures products that are new or equivalent to new in accordance with industry standard. NEXCOM warrants that products will be free from defect in material and workmanship for 2 years, beginning on the date of invoice by NEXCOM. HCP series products (Blade Server) which are manufactured by NEXCOM are covered by a three year warranty period.

NEXCOM Return Merchandise Authorization (RMA)

- Customers shall enclose the “NEXCOM RMA Service Form” with the returned packages.
- Customers must collect all the information about the problems encountered and note anything abnormal or, print out any on-screen messages, and describe the problems on the “NEXCOM RMA Service Form” for the RMA number apply process.
- Customers can send back the faulty products with or without accessories (manuals, cable, etc.) and any components from the card, such as CPU and RAM. If the components were suspected as part of the problems, please note clearly which components are included. Otherwise, NEXCOM is not responsible for the devices/parts.
- Customers are responsible for the safe packaging of defective products, making sure it is durable enough to be resistant against further damage and deterioration during transportation. In case of damages occurred during transportation, the repair is treated as “Out of Warranty.”
- Any products returned by NEXCOM to other locations besides the customers’ site will bear an extra charge and will be billed to the customer.

Repair Service Charges for Out-of-Warranty Products

NEXCOM will charge for out-of-warranty products in two categories, one is basic diagnostic fee and another is component (product) fee.

Repair Service Charges for Out-of-Warranty Products

NEXCOM will charge for out-of-warranty products in two categories, one is basic diagnostic fee and another is component (product) fee.

System Level

- Component fee: NEXCOM will only charge for main components such as SMD chip, BGA chip, etc. Passive components will be repaired for free, ex: resistor, capacitor.
- Items will be replaced with NEXCOM products if the original one cannot be repaired. Ex: motherboard, power supply, etc.
- Replace with 3rd party products if needed.
- If RMA goods can not be repaired, NEXCOM will return it to the customer without any charge.

Board Level

- Component fee: NEXCOM will only charge for main components, such as SMD chip, BGA chip, etc. Passive components will be repaired for free, ex: resistors, capacitors.
- If RMA goods can not be repaired, NEXCOM will return it to the customer without any charge.

Warnings

Read and adhere to all warnings, cautions, and notices in this guide and the documentation supplied with the chassis, power supply, and accessory modules. If the instructions for the chassis and power supply are inconsistent with these instructions or the instructions for accessory modules, contact the supplier to find out how you can ensure that your computer meets safety and regulatory requirements.

Cautions

Electrostatic discharge (ESD) can damage system components. Do the described procedures only at an ESD workstation. If no such station is available, you can provide some ESD protection by wearing an antistatic wrist strap and attaching it to a metal part of the computer chassis.

Safety Information

Before installing and using the device, note the following precautions:

- Read all instructions carefully.
- Do not place the unit on an unstable surface, cart, or stand.
- Follow all warnings and cautions in this manual.
- When replacing parts, ensure that your service technician uses parts specified by the manufacturer.
- Avoid using the system near water, in direct sunlight, or near a heating device.
- The load of the system unit does not solely rely for support from the rackmounts located on the sides. Firm support from the bottom is highly necessary in order to provide balance stability.
- The computer is provided with a battery-powered real-time clock circuit. There is a danger of explosion if battery is incorrectly replaced. Replace only with the same or equivalent type recommended by the manufacturer. Discard used batteries according to the manufacturer's instructions.

Installation Recommendations

Ensure you have a stable, clean working environment. Dust and dirt can get into components and cause a malfunction. Use containers to keep small components separated.

Adequate lighting and proper tools can prevent you from accidentally damaging the internal components. Most of the procedures that follow require only a few simple tools, including the following:

- A Philips screwdriver
- A flat-tipped screwdriver
- A grounding strap
- An anti-static pad

Using your fingers can disconnect most of the connections. It is recommended that you do not use needle-nose pliers to disconnect connections as these can damage the soft metal or plastic parts of the connectors.

Safety Precautions

1. Read these safety instructions carefully.
2. Keep this User Manual for later reference.
3. Disconnect the equipment from any AC outlet before cleaning or installing a component inside the chassis. Use a damp cloth. Do not use liquid or spray detergents for cleaning.
4. To prevent electrostatic build-up, leave the board in its anti-static bag until you are ready to install it.
5. For plug-in equipment, the power outlet socket must be located near the equipment and must be easily accessible.
6. Keep the board away from humidity.
7. Put the board on a stable surface. Dropping it or letting it fall may cause damage.
8. Wear anti-static wrist strap.
9. Do all preparation work on a static-free surface.
10. Make sure the voltage of the power source is correct before connecting the equipment to the power outlet.
11. Hold the board only by its edges. Be careful not to touch any of the components, contacts or connections.
12. All cautions and warnings on the board should be noted.
13. Use the correct mounting screws and do not over tighten the screws.
14. Keep the original packaging and the anti-static bag; in case the board has to be returned for repair or replacement.

Technical Support and Assistance

1. For the most updated information of NEXCOM products, visit NEXCOM's website at www.nexcom.com.
2. For technical issues that require contacting our technical support team or sales representative, please have the following information ready before calling:
 - Product name and serial number
 - Detailed information of the peripheral devices
 - Detailed information of the installed software (operating system, version, application software, etc.)
 - A complete description of the problem
 - The exact wordings of the error messages

Warning!

1. Handling the unit: carry the unit with both hands and handle it with care.
2. Maintenance: to keep the unit clean, use only approved cleaning products or clean with a dry cloth.

Conventions Used in this Manual



Warning:

Information about certain situations, which if not observed, can cause personal injury. This will prevent injury to yourself when performing a task.



Caution:

Information to avoid damaging components or losing data.



Note:

Provides additional information to complete a task easily.

Global Service Contact Information

Headquarters

NEXCOM International Co., Ltd.

9F, No. 920, Chung-Cheng Rd.,
ZhongHe District, New Taipei City, 23586,
Taiwan, R.O.C.

Tel: +886-2-8226-7786

Fax: +886-2-8226-7782

www.nexcom.com

America

USA

NEXCOM USA

2883 Bayview Drive,
Fremont CA 94538, USA

Tel: +1-510-656-2248

Fax: +1-510-656-2158

Email: sales@nexcom.com

www.nexcom.com

Asia

Taiwan

NEXCOM Intelligent Systems

Taipei Office

13F, No.920, Chung-Cheng Rd.,
ZhongHe District,
New Taipei City, 23586, Taiwan, R.O.C.

Tel: +886-2-8226-7796

Fax: +886-2-8226-7792

Email: sales@nexcom.com.tw

www.nexcom.com.tw

NEXCOM Intelligent Systems

Taichung Office

16F, No.250, Sec. 2, Chongde Rd.,
Beitun Dist.,

Taichung City 406, R.O.C.

Tel: +886-4-2249-1179

Fax: +886-4-2249-1172

Email: sales@nexcom.com.tw

www.nexcom.com.tw

Japan

NEXCOM Japan

9F, Tamachi Hara Bldg.,
4-11-5, Shiba Minato-ku,
Tokyo, 108-0014, Japan

Tel: +81-3-5419-7830

Fax: +81-3-5419-7832

Email: sales@nexcom-jp.com

www.nexcom-jp.com

China

NEXCOM China

1F & 2F, Block A, No. 16 Yonyou Software Park,
No. 68 Beiqing Road, Haidian District,
Beijing, 100094, China

Tel: +86-10-5704-2680

Fax: +86-10-5704-2681

Email: sales@nexcom.cn

www.nexcom.cn

NEXCOM Shanghai

Room 603/604, Huiyinmingzun Plaza Bldg., 1,
No.609, Yunlin East Rd.,
Shanghai, 200333, China
Tel: +86-21-5278-5868
Fax: +86-21-3251-6358
Email: sales@nexcom.cn
www.nexcom.cn

NEXCOM Surveillance Technology Corp.

Room202, Building B,
the GuangMing Industrial Zone Zhonghua Rd.,
Minzhi Street, Longhua District,
Shenzhen 518131, China
Tel: +86-755-8364-7768
Fax: +86-755-8364-7738
Email: steveyang@nexcom.com.tw
www.nexcom.cn

NEXCOM United System Service

Hui Yin Ming Zun Building Room 1108,
Building No. 11, 599 Yunling Road, Putuo District,
Shanghai, 200062, China
Tel: +86-21-6125-8282
Fax: +86-21-6125-8281
Email: frankyang@nexcom.cn
www.nexcom.cn

Europe**United Kingdom****NEXCOM EUROPE**

10 Vincent Avenue,
Crownhill Business Centre,
Milton Keynes, Buckinghamshire
MK8 0AB, United Kingdom
Tel: +44-1908-267121
Fax: +44-1908-262042
Email: sales.uk@nexcom.eu
www.nexcom.eu

Italy**NEXCOM ITALIA S.r.l**

Via Lanino 42,
21047 Saronno (VA), Italia
Tel: +39 02 9628 0333
Fax: +39 02 9625 570
Email: nexcomitalia@nexcom.eu
www.nexcomitalia.it

Package Contents

Before continuing, verify that the EBC 357X package that you received is complete. Your package should have all the items listed in the following table.

Item	Part Number	Name	Qty
1	60177A0569X00	EBC 357X Quick Reference Guide VER:A	1
2	602DCD1317X00	EBC 357X CD Driver VER:1.0	1

Optional Accessories

Item	Part Number	Name
1	60233SIO62X00	COM Port Cable CP:NEX-110819-01
2	60233PS223X00	EBC 563 IO PS2 KB/MS Cable ACMELUX:19922439
3	60233ATA73X00	SATA Cable ACMELUX:19922413
4	60233PW148X00	SATA Power Cable BEST:901-0405-300R
5	10E000TPM00X0	EBK-TPM-1.2
6	10E000TPM01X0	EBK-TPM-2.0
7	10E00035702X0	EBC 357X Heat Spreader Kit
8	10E00035501X0	EBC 355 Cable Kit

Ordering Information

The following below provides ordering information for EBC 357X.

EBC 357X-E3950 (P/N: 10E00035700X0) RoHS Compliant

Low power embedded board with Intel® Atom™ processor E3950 and extended -40°C to + 85°C, w/ HDMI/VGA/24/48bit LVDS/4 x USB 3.0/4 x COMs/1 x mini-PCIe/1 x NGFF(M.2)/2 x Gigabit LAN/2 x SATA

EBC 357X-E3930 (P/N: 10E00035701X0) RoHS Compliant

Low power embedded board with Intel® Atom™ processor E3930 and extended -40°C to + 85°C, w/ HDMI/VGA/24/48bit LVDS/4 x USB 3.0/4 x COMs/1 x mini-PCIe/1 x NGFF(M.2)/2 x Gigabit LAN/2 x SATA

CHAPTER 1: PRODUCT INTRODUCTION

Overview

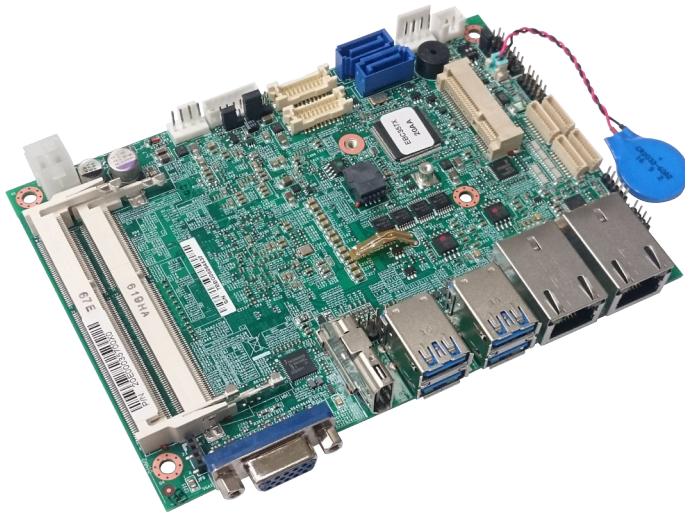

Key Features

- On-board Intel® Atom™ processor E39xx processor family
- CPU upside down design
- 2x 204-pin SO-DIMM DDR3L
- Triple display: HDMI/VGA/LVDS
- 1x mini-PCIe/1x NGFF
- 2x Intel® i210-IT PCI Express Gigabit Ethernet
- 2x SATA 2.0
- 4x USB 3.0, 4-in/4-out GPIO, Mic-in, Speaker-out
- Serial port: 3x RS232, 1x RS232/422/485 port
- Support AT/ATX mode and single +12VDC input

Hardware Specifications

CPU Support

- Intel® Atom™ processor E39xx processor family, 14nm core, Quad/Dual core, 1.8/2.0GHz, 2 x L2-Cache 1MB 16-way shared per 2 cores, TDP: 6.5W/12W

Main Memory

- Dual DDR3L/SO-DIMMs, up to 16GB

BIOS

- AMI system BIOS
- Plug and play support

Display

- 1x HDMI connector (resolution up to 3840 x 2160@30Hz)
- 1x VGA connector (resolution up to 1920 x 1200)
- LVDS interface: 1x dual (24/48-bit) LVDS panel, resolution up to 1920 x 1200 DF13 20-pin LVDS connector for internal connection

Storage

- 1x eMMC 5.0 support (optional)
- 2x 7-pin SATA connector, one of the SATA supports SATA-DOM

Audio

- Realtek ALC886 HD Codec
- 1x 4 pin-header for mic-in, 2.0 pitch
- 1x 4 pin-header for line-out, 2.0 pitch
- 1x 5 pin-header for speaker-out, 2.0 pitch

On-board LAN

- 2x Intel® I210-IT GbE controller
- Support PXE boot from LAN, wake on LAN function

Expansion Slot

- 1x NGFF (M.2) supports M.2 SSD (optional), WWAN, 3G, pin header for SIM
- 1x mini-PCI express slot supports mSATA (optional) and Wi-Fi module

Power Requirements

- AT/ATX mode (by jumper setting default-AT)
- 4-pin power connector (right angle) for DC power input
- Single power 12V DC input

I/O Interface

- Serial port x 4
COM1/3/4: RS232 1x 10 pin 1.0mm JST connector
COM2: RS232/422/485, 1x 10 pin 1.0mm JST connector
- 4-in/4-out GPIO
- One 2x 7 2.0mm pin header with SMBus/power ON-OFF/system reset/power/storage LED
- One 4-pin header with VCC 3.3V/TX/RX/GND for ZigBee module
- One 4-pin fan connector supporting PWM fan
- One 2 x 4/2.54mm pin header for PS2 keyboard & mouse

Optional Function

- TPM module (EBK-TPM)
- PoE PD module support

Dimensions

- 146mm (L) x 102mm (W) (5.7" x 4.0")

Environment

- Board level operating temperatures: -40°C to 85°C

Relative Humidity

- 10% to 90% (operating, non-condensing)
- 5% to 95% (non-operating, non-condensing)

Certifications

- Meet CE
- FCC Class A

Knowing Your EBC 357X

Top View

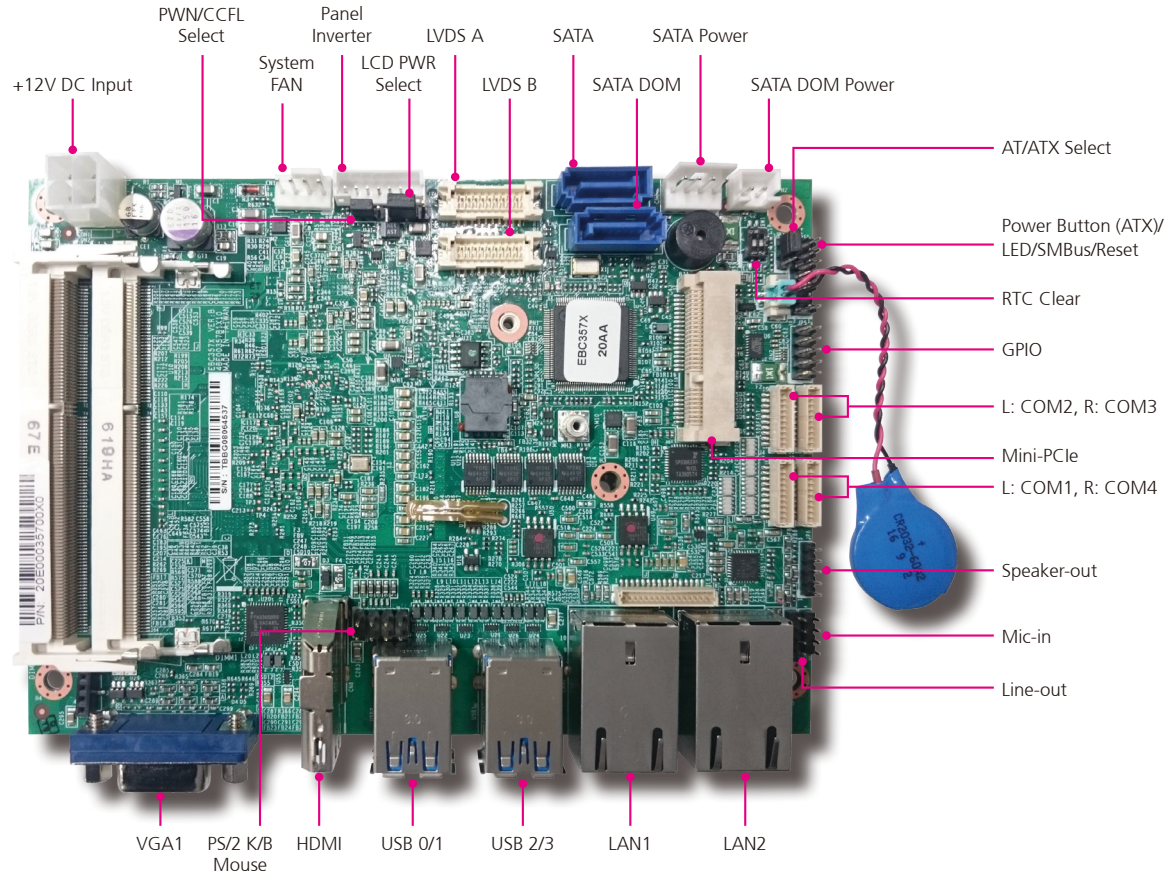

Bottom View

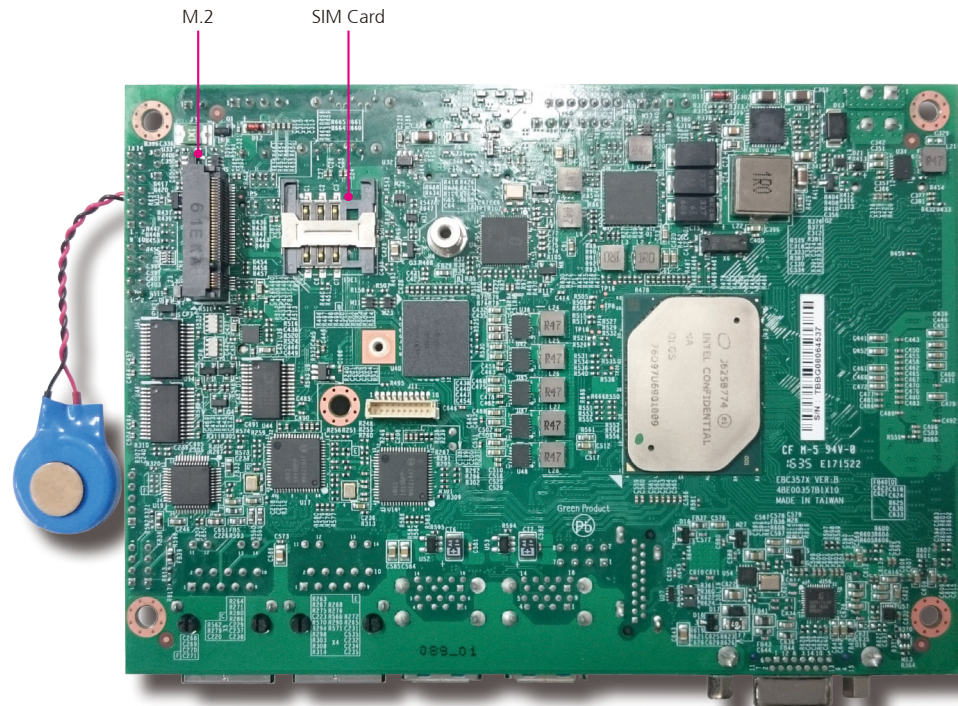

CHAPTER 2: JUMPERS AND CONNECTORS

This chapter describes how to set the jumpers and connectors on the EBC 357X motherboard.

Before You Begin

- Ensure you have a stable, clean working environment. Dust and dirt can get into components and cause a malfunction. Use containers to keep small components separated.
- Adequate lighting and proper tools can prevent you from accidentally damaging the internal components. Most of the procedures that follow require only a few simple tools, including the following:
 - A Philips screwdriver
 - A flat-tipped screwdriver
 - A set of jewelers screwdrivers
 - A grounding strap
 - An anti-static pad
- Using your fingers can disconnect most of the connections. It is recommended that you do not use needle-nosed pliers to disconnect connections as these can damage the soft metal or plastic parts of the connectors.
- Before working on internal components, make sure that the power is off. Ground yourself before touching any internal components, by touching a metal object. Static electricity can damage many of the electronic components. Humid environments tend to have less static electricity than

dry environments. A grounding strap is warranted whenever danger of static electricity exists.

Precautions

Computer components and electronic circuit boards can be damaged by discharges of static electricity. Working on computers that are still connected to a power supply can be extremely dangerous.

Follow the guidelines below to avoid damage to your computer or yourself:

- Always disconnect the unit from the power outlet whenever you are working inside the case.
- If possible, wear a grounded wrist strap when you are working inside the computer case. Alternatively, discharge any static electricity by touching the bare metal chassis of the unit case, or the bare metal body of any other grounded appliance.
- Hold electronic circuit boards by the edges only. Do not touch the components on the board unless it is necessary to do so. Don't flex or stress the circuit board.
- Leave all components inside the static-proof packaging that they shipped with until they are ready for installation.
- Use correct screws and do not over tighten screws.

Jumper Settings

A jumper is the simplest kind of electric switch. It consists of two metal pins and a cap. When setting the jumpers, ensure that the jumper caps are placed on the correct pins. When the jumper cap is placed on both pins, the jumper is short. If you remove the jumper cap, or place the jumper cap on just one pin, the jumper is open.

Refer to the illustrations below for examples of what the 2-pin and 3-pin jumpers look like when they are short (on) and open (off).

Two-Pin Jumpers: Open (Left) and Short (Right)

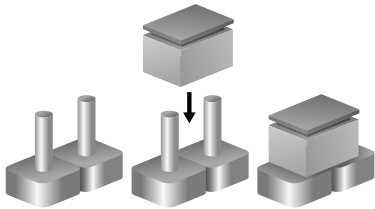

Three-Pin Jumpers: Pins 1 and 2 are Short

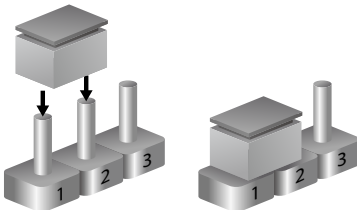

Locations of the Jumpers and Connectors

The figure below shows the location of the jumpers and connectors.

Top View

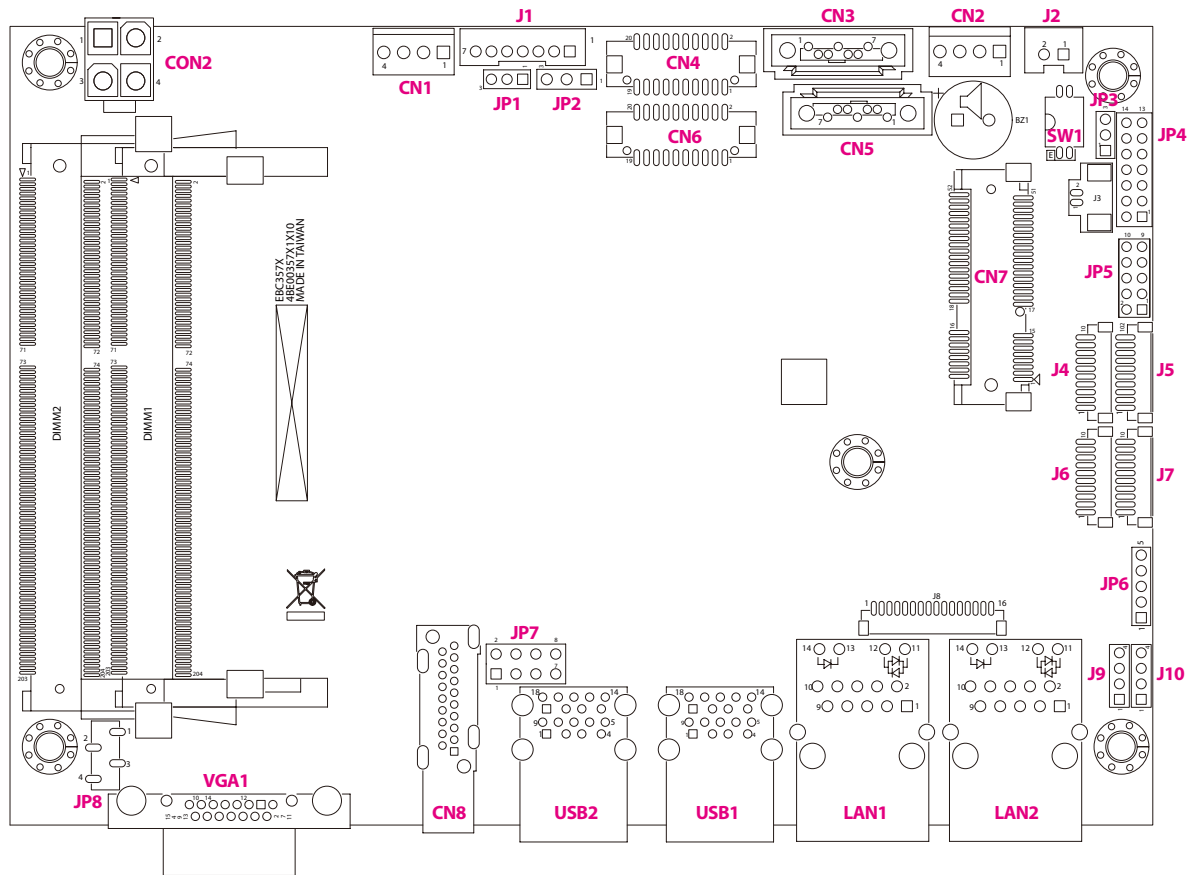

Bottom View

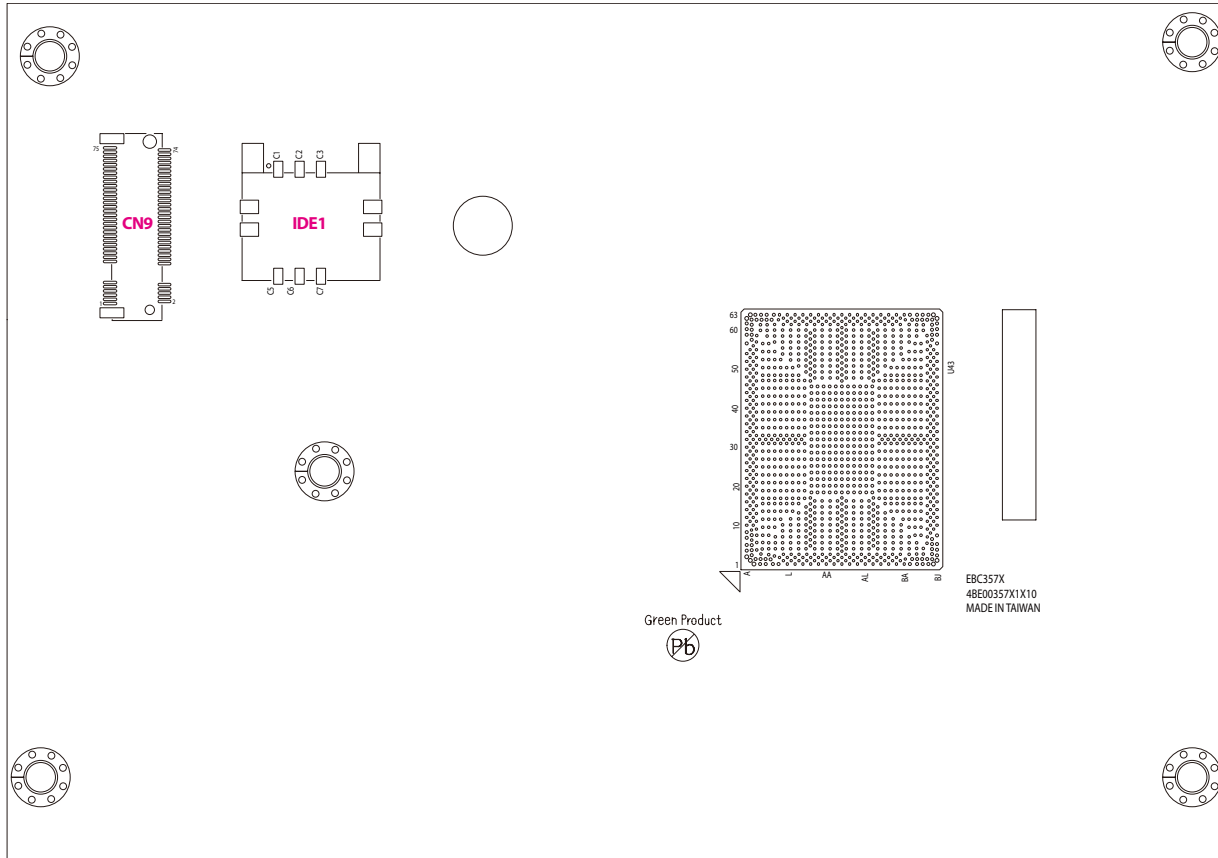

Jumpers and DIP Switch Settings

AT/ATX Power Type Select

Connector type: 1x3 3-pin header, 2.0mm pitch

Connector location: JP3



Pin	Definition
1	ATX_PWRBT#
2	PWRBTN#
3	AT_PWRBT#

RTC Clear Select

Connector type: 2-pin DIP switch

Connector location: SW1



Pin	Definition
1	S_RTC_RST#
2	GND
3	S_RTC_TEST#
4	GND

LCD Power Select

Connector type: 1x3 3-pin header, 2.54mm pitch

Connector location: JP2



Pin	Settings
1-2 On	VCC3
2-3 On	VCC5

1-2 On: default

Pin	Definition
1	+3V3
2	+VCCLCDIN
3	+5V

PWM/CCFL Select

Connector type: 1x3 3-pin header, 2.0mm pitch

Connector location: JP1



Pin	Definition
1	CCFLBKLTCTRL
2	PL_BKLTCTRL
3	PWM_CTRL

Connector Pin Definitions

External I/O Interfaces

VGA

Connector type: DB-15 port, 15-pin D-Sub

Connector location: VGA1

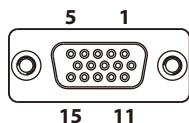

Pin	Definition	Pin	Definition
1	VGA_RED_C	2	VGA_GREEN_C
3	VGA_BLUE_C	4	NC
5	GND	6	GND
7	GND	8	GND
9	+5V_VGA	10	GND
11	NC	12	VGA_DDCDATA_C
13	VGA_HSYNC_C	14	VGA_VSYNC_C
15	VGA_DDCCLK_C		

HDMI Ports

Connector type: HDMI port

Connector location: CN8

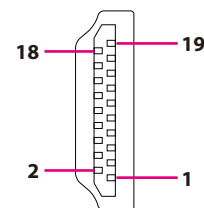

Pin	Definition	Pin	Definition
1	HDMI_DATA2_P_C	2	GND
3	HDMI_DATA2_N_C	4	HDMI_DATA1_P_C
5	GND	6	HDMI_DATA1_N_C
7	HDMI_DATA0_P_C	8	GND
9	HDMI_DATA0_N_C	10	HDMI_CLK_P_C
11	GND	12	HDMI_CLK_N_C
13	NC	14	NC
15	HDMI_CTRL_CLK_C	16	HDMI_CTRL_DATA_C
17	GND	18	+HDMI_5V
19	HDMI_HPD_C	MH1	GND
MH2	GND	MH3	GND
MH4	GND		

Dual USB 3.0 Port A

Connector type: Dual USB 3.0 port

Connector location: USB2

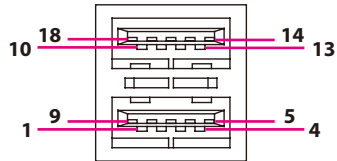

Pin	Definition	Pin	Definition
1	P5V_OC01_C	2	USB_0N_C
3	USB_0P_C	4	GND
5	USB3_RX0_N_C	6	USB3_RX0_P_C
7	GND	8	USB3_TX0_N_C
9	USB3_TX0_P_C	10	P5V_OC01_C
11	USB_1N_C	12	USB_1P_C
13	GND	14	USB3_RX1_N_C
15	USB3_RX1_P_C	16	GND
17	USB3_TX1_N_C	18	USB3_TX1_P_C

Dual USB 3.0 Port B

Connector type: Dual USB 3.0 port

Connector location: USB1

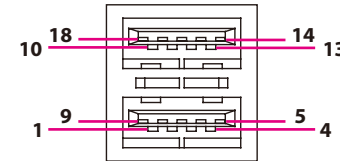

Pin	Definition	Pin	Definition
1	P5V_OC23_C	2	USB_2N_C
3	USB_2P_C	4	GND
5	USB3_RX2_N_C	6	USB3_RX2_P_C
7	GND	8	USB3_TX2_N_C
9	USB3_TX2_P_C	10	P5V_OC23_C
11	USB_3N_C	12	USB_3P_C
13	GND	14	USB3_RX3_N_C
15	USB3_RX3_P_C	16	GND
17	USB3_TX3_N_C	18	USB3_TX3_P_C

LAN1 Port

Connector type: RJ45 port with LEDs

Connector location: LAN1

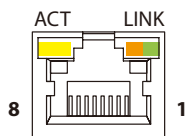

Act	Status
Flashing Yellow	Data activity
Off	No activity

Link	Status
Steady Green	1G network link
Steady Orange	100Mbps network link
Off	10Mbps or no link

Pin	Definition	Pin	Definition
1	MDI_0_P_1	2	MDI_0_N_1
3	MDI_1_P_1	4	MDI_1_N_1
5	+1V5_LAN1	6	GND
7	MDI_2_P_1	8	MDI_2_N_1
9	MDI_3_P_1	10	MDI_3_N_1
11	LED0_1	12	LED2_1
13	LED1_1	14	+3VSB

LAN2 Port

Connector type: RJ45 port with LEDs

Connector location: LAN2

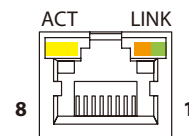

Act	Status
Flashing Yellow	Data activity
Off	No activity

Link	Status
Steady Green	1G network link
Steady Orange	100Mbps network link
Off	10Mbps or no link

Pin	Definition	Pin	Definition
1	MDI_0_P_2	2	MDI_0_N_2
3	MDI_1_P_2	4	MDI_1_N_2
5	+1V5_LAN2	6	GND
7	MDI_2_P_2	8	MDI_2_N_2
9	MDI_3_P_2	10	MDI_3_N_2
11	LED0_2	12	LED2_2
13	LED1_2	14	+3VSB

Internal Connectors

ATX Power Output Connector

Connector type: 2x2 Aux power connector

Connector location: CON2

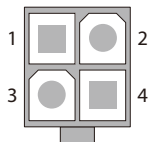

Pin	Definition
1	GND
2	GND
3	12V
4	12V

Power Button/LED/SMBus/Reset

Connector type: 2x7 14-pin header, 2.0mm pitch

Connector location: JP4

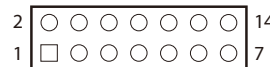

Pin	Definition	Pin	Definition
1	PWRLEDP	2	+3V3
3	HDDLEDP	4	+3V3
5	S_SMB_CLK	6	+3V3
7	S_SMB_DATA	8	GND
9	S_SLP_S3#	10	PS_ON
11	RSTBTN#	12	GND
13	ATX_PWRBT#	14	GND

PS/2 Keyboard/Mouse Connector

Connector type: 2x4 8-pin header, 2.54mm pitch
Connector location: JP7

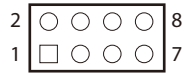

Pin	Definition	Pin	Definition
1	+5V_KB	2	+5V_KB
3	KDAT_R	4	MDAT_R
5	KCLK_R	6	MCLK_R
7	GND	8	GND

System Fan Connector

Connector type: 1x4 4-pin Wafer, 2.54mm pitch
Connector location: CN1



Pin	Definition
1	GND
2	+12V
3	CPUFANIN_P
4	CPUFANOUT_R

GPIO Connector

Connector type: 2x5 10-pin header, 2.0mm pitch

Connector location: JP5

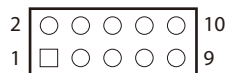

Pin	Definition	Pin	Definition
1	+5V_IO	2	GND
3	ICH_GPO0_OUT	4	ICH_GPIO_IN
5	ICH_GPO1_OUT	6	ICH_GPI1_IN
7	ICH_GPO2_OUT	8	ICH_GPI2_IN
9	ICH_GPO3_OUT	10	ICH_GPI3_IN

COM Port 1 (RS232)

Connector type: 1x10 10-pin header, 1.0mm pitch

Connector location: J6

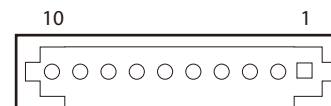

Pin	Definition	Pin	Definition
1	SP1_DCD	2	SP1_RXD
3	SP1_TXD	4	SP1_DTR
5	GND	6	SP1_DSR
7	SP1_RTS	8	SP1_CTS
9	SP1_RI	10	GND

COM Port 2 (RS232/RS422/RS485)

Connector type: 1x10 10-pin header, 1.0mm pitch

Connector location: J4

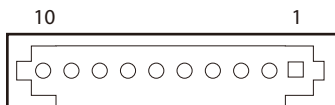

Pin	Definition	Pin	Definition
1	SP2_DCD	2	SP2_RXD
3	SP2_TXD	4	SP2_DTR
5	GND	6	SP2_DSR
7	SP2_RTS	8	SP2_CTS
9	SP2_RI	10	GND

COM Port 3 (RS232)

Connector type: 1x10 10-pin header, 1.0mm pitch

Connector location: J5

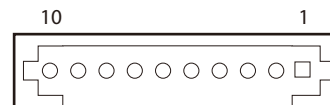

Pin	Definition	Pin	Definition
1	SP3_DCD	2	SP3_RXD
3	SP3_TXD	4	SP3_DTR
5	GND	6	SP3_DSR
7	SP3_RTS	8	SP3_CTS
9	SP3_RI	10	GND

COM Port 4 (RS232)

Connector type: 1x10 10-pin header, 1.0mm pitch

Connector location: J7

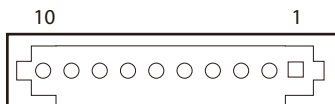

Pin	Definition	Pin	Definition
1	SP4_DCD	2	SP4_RXD
3	SP4_TXD	4	SP4_DTR
5	GND	6	SP4_DSR
7	SP4_RTS	8	SP4_CTS
9	SP4_RI	10	GND

Mic-in Connector

Connector type: 1x4 4-pin header, 2.0mm pitch

Connector location: J10



Pin	Definition
1	MIC1-L3_C
2	MIC_GND
3	MIC1_JD
4	MIC1-R3_C

Line-out Connector

Connector type: 1x4 4-pin header, 2.0mm pitch

Connector location: J9



Pin	Definition
1	HP_OUTL_R2
2	GND
3	LINE2_JD
4	HP_OUTR_R2

Speaker-out Connector

Connector type: 1x5 5-pin header, 2.0mm pitch

Connector location: JP6



Pin	Definition	Pin	Definition
1	LOUT_P_R_C	2	LOUT_N_R_C
3	GND	4	ROUT_P_R_C
5	ROUT_N_R_C		

LVDS Channel A

Connector type: 2x10 20-pin header, 1.25mm pitch

Connector location: CN4

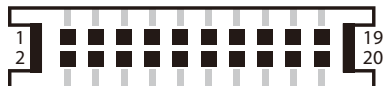

Pin	Definition	Pin	Definition
1	LVDS_DDC_CLK	2	LVDS_DDC_DATA
3	+VCC_LCD	4	LVDSA_LDC0P
5	LVDSA_LDC3P	6	LVDSA_LDC0N
7	LVDSA_LDC3N	8	+VCC_LCD
9	GND	10	LVDSA_LDC1P
11	LVDSA_LL1CP	12	LVDSA_LDC1N
13	LVDSA_LL1CN	14	GND
15	GND	16	+V_INV
17	LVDSA_LDC2P	18	+V_INV
19	LVDSA_LDC2N	20	GND

LVDS Channel B

Connector type: 2x10 20-pin header, 1.25mm pitch

Connector location: CN6

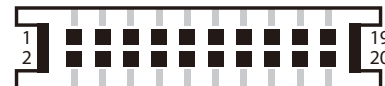

Pin	Definition	Pin	Definition
1	LVDS_DDC_CLK	2	LVDS_DDC_DATA
3	+VCC_LCD	4	LVDSA_LDC4P
5	LVDSB_LDC7P	6	LVDSA_LDC4N
7	LVDSA_LDC7N	8	+VCC_LCD
9	GND	10	LVDSA_LDC5P
11	LVDSA_LL2CP	12	LVDSA_LDC5N
13	LVDSA_LL2CN	14	GND
15	GND	16	+V_INV
17	LVDSA_LDC6P	18	+V_INV
19	LVDSA_LDC6N	20	GND

LVDS Panel Inverter Connector

Connector type: 1x7 7-pin header JST, 2.0mm pitch

Connector location: J1

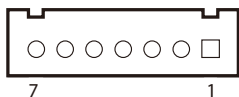

Pin	Definition	Pin	Definition
1	+5V	2	+V_INV
3	+V_INV	4	PL_BKLTCTRL
5	GND	6	GND
7	M_BKLTEN_R		

UART Pin Header

Connector type: 1x4 4-pin header, 2.0mm pitch

Connector location: JP8

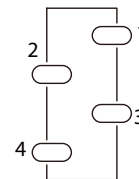

Pin	Definition
1	+3V3
2	Zigbee_TXD
3	Zigbee_RXD
4	GND

SIM Card Connector

Connector type: SIM card slot

Connector location: IDE1

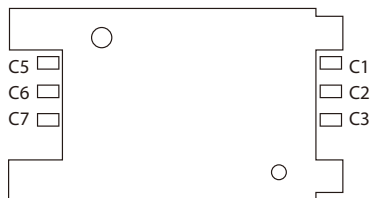

Pin	Definition	Pin	Definition
C1	UIM_PWER	C2	UIM_REST
C3	UIM_CLK	C5	GND
C6	UIM_PWER	C7	UIM_DATA

SATA Connector A

Connector type: Standard Serial ATA 7P (1.27mm, SATA-M-180)

Connector location: CN3

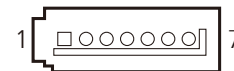

Pin	Definition	Pin	Definition
1	GND	2	SATA_TXP0_C
3	SATA_TXN0_C	4	GND
5	SATA_RXN0_C	6	SATA_RXP0_C
7	GND		

SATA DOM Connector

Connector type: Standard Serial ATA 7P (1.27mm, SATA-M-180)
Connector location: CN5

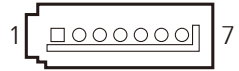

Pin	Definition	Pin	Definition
1	GND	2	SATA_TXP1_C
3	SATA_TXN1_C	4	GND
5	SATA_RXN1_C	6	SATA_RXP1_C
7	GND		

SATA Power Connector

Connector type: 1x4 4-pin Wafer, 2.54mm pitch
Connector location: CN2



Pin	Definition
1	+12V
2	GND
3	GND
4	+5V

SATA DOM Power Connector

Connector type: 1x2 JST, 2-pin header, 2.5mm pitch

Connector location: J2



Pin	Definition
1	+5V_SATA
2	GND

Mini-PCIe Connector (Wi-Fi)

Connector location: CN7

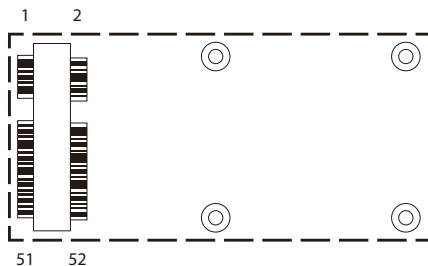

Pin	Definition	Pin	Definition
1	PCIE_0_WAKE#	2	GND+3VSB_MINI1
3	NC	4	GND
5	NC	6	+1V5_MINI1
7	NC	8	NC
9	GND	10	NC
11	CLK_MINI_N_C	12	NC
13	CLK_MINI_P_C	14	NC
15	GND	16	NC
17	NC	18	GND
19	NC	20	W_DISABLE#
21	GND	22	MINI_PLTRST#
23	PCIE_mSATA_RXN	24	+3VSB_MINI1
25	PCIE_mSATA_RXP	26	GND

Pin	Definition	Pin	Definition
27	GND	28	+1V5_MINI1
29	GND	30	MINI1_CLK
31	PCIE_mSATA_TXN	32	MINI1_DAT
33	PCIE_mSATA_TXP	34	GND
35	GND	36	S_USB2_DN4_C
37	GND	38	S_USB2_DP4_C
39	+3VSB_MINI1	40	GND
41	+3VSB_MINI1	42	NC
43	GND	44	NC
45	NC	46	NC
47	NC	48	+1V5_MINI1
49	NC	50	GND
51	PCIE_mSATA_SEL_51	52	+3VSB_MINI1

M.2 Connector

Connector location: CN9

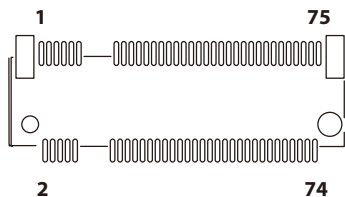

Pin	Definition	Pin	Definition
1	NGFF_CONFIG_3	2	+3V3_NGFF_M2
3	GND	4	+3V3_NGFF_M2
5	GND	6	NGFF_POWER_OFF#
7	NGFF_USB2_DP	8	NGFF_W_DISABLE#
9	NGFF_USB2_DN	10	NC
11	NC	12	
13		14	
15		16	
17		18	
19		20	NC
21	NGFF_CONFIG_0	22	NC
23	NC	24	NC
25	NC	26	NGFF_WWAN_GPS_ON
27	GND	28	NC
29	NC	30	UIM_REST
31	NC	32	UIM_CLK
33	GND	34	UIM_DATA
35	NC	36	UIM_PWER
37	NC	38	SATA_DEVSLP1

Pin	Definition	Pin	Definition
39	GND	40	NC
41	NGFF_PE_SSD_RXP1	42	NC
43	NGFF_PE_SSD_RXN1	44	NC
45	GND	46	NC
47	NGFF_PE_SSD_TXN1	48	NC
49	NGFF_PE_SSD_TXP1	50	NGFF_PERSET#
51	GND	52	NC
53	NGFF_CLK_N_C	54	NGFF_WAKE#
55	NGFF_CLK_P_C	56	NGFF_SMB_CLK
57	GND	58	NGFF_SMB_DAT
59	NC	60	NC
61	NC	62	NC
63	NC	64	NC
65	NC	66	NGFF_SIM_DETECT
67	N_PLTRST#	68	NGFF_SUSCLK
69	NGFF_CONFIG_1	70	+3V3_NGFF_M2
71	GND	72	+3V3_NGFF_M2
73	GND	74	+3V3_NGFF_M2
75	NGFF_CONFIG_2		

Block Diagram

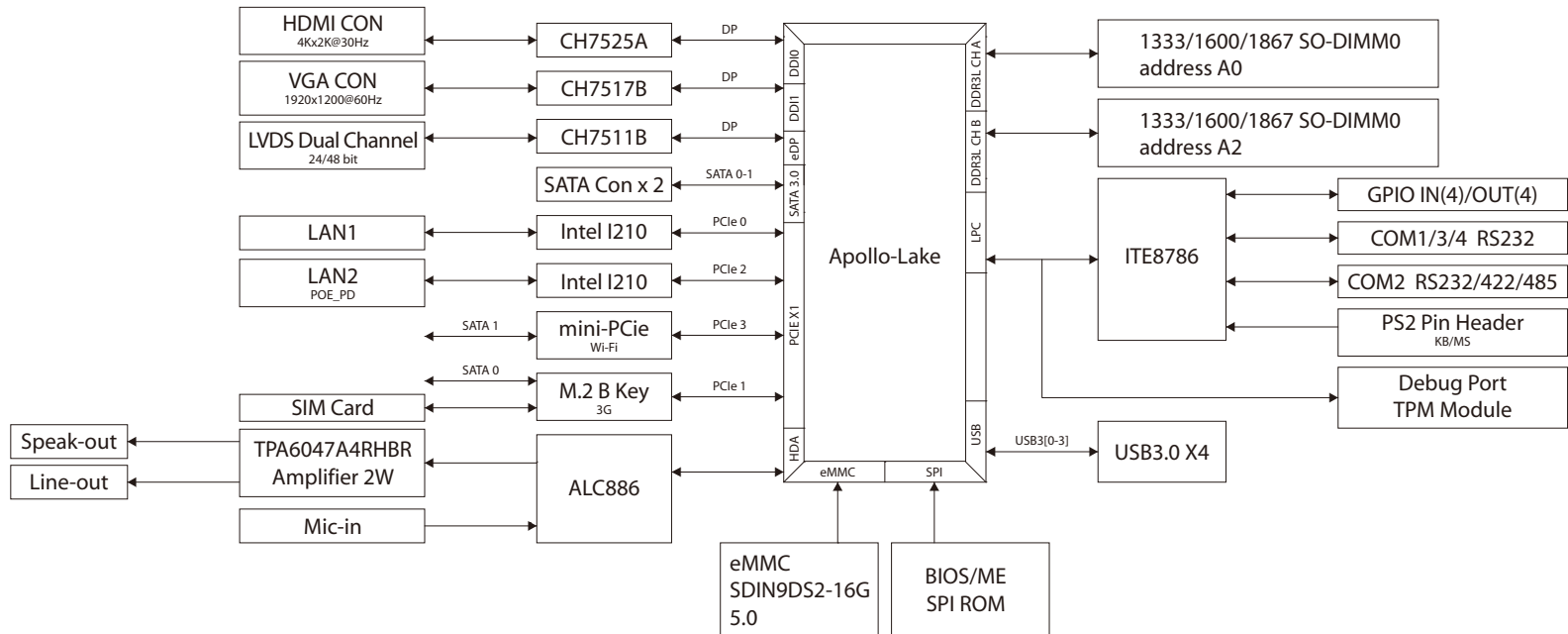

CHAPTER 3: BIOS SETUP

This chapter describes how to use the BIOS setup program for EBC 357X. The BIOS screens provided in this chapter are for reference only and may change if the BIOS is updated in the future.

To check for the latest updates and revisions, visit the NEXCOM Web site at www.nexcom.com.tw.

About BIOS Setup

The BIOS (Basic Input and Output System) Setup program is a menu driven utility that enables you to make changes to the system configuration and tailor your system to suit your individual work needs. It is a ROM-based configuration utility that displays the system's configuration status and provides you with a tool to set system parameters.

These parameters are stored in non-volatile battery-backed-up CMOS RAM that saves this information even when the power is turned off. When the system is turned back on, the system is configured with the values found in CMOS.

With easy-to-use pull down menus, you can configure such items as:

- Hard drives, diskette drives, and peripherals
- Video display type and display options
- Password protection from unauthorized use
- Power management features

The settings made in the setup program affect how the computer performs. It is important, therefore, first to try to understand all the setup options, and second, to make settings appropriate for the way you use the computer.

When to Configure the BIOS

This program should be executed under the following conditions:

- When changing the system configuration
- When a configuration error is detected by the system and you are prompted to make changes to the setup program
- When resetting the system clock
- When redefining the communication ports to prevent any conflicts
- When making changes to the Power Management configuration
- When changing the password or making other changes to the security setup

Normally, CMOS setup is needed when the system hardware is not consistent with the information contained in the CMOS RAM, whenever the CMOS RAM has lost power, or the system features need to be changed.

Default Configuration

Most of the configuration settings are either predefined according to the Load Optimal Defaults settings which are stored in the BIOS or are automatically detected and configured without requiring any actions. There are a few settings that you may need to change depending on your system configuration.

Entering Setup











When the system is powered on, the BIOS will enter the Power-On Self Test (POST) routines. These routines perform various diagnostic checks; if an error is encountered, the error will be reported in one of two different ways:

- If the error occurs before the display device is initialized, a series of beeps will be transmitted.
- If the error occurs after the display device is initialized, the screen will display the error message.

Powering on the computer and immediately pressing allows you to enter Setup.

Press the  key to enter Setup:

Legends

Key	Function
	Moves the highlight left or right to select a menu.
	Moves the highlight up or down between sub-menu or fields.
	Exits the BIOS Setup Utility.
	Scrolls forward through the values or options of the highlighted field.
	Scrolls backward through the values or options of the highlighted field.
	Selects a field.
	Displays General Help.
	Load previous values.
	Load optimized default values.
	Saves and exits the Setup program.
	Press <Enter> to enter the highlighted sub-menu

Scroll Bar

When a scroll bar appears to the right of the setup screen, it indicates that there are more available fields not shown on the screen. Use the up and down arrow keys to scroll through all the available fields.

Submenu

When “▶” appears on the left of a particular field, it indicates that a submenu which contains additional options are available for that field. To display the submenu, move the highlight to that field and press  .

BIOS Setup Utility

Once you enter the AMI BIOS Setup Utility, the Main Menu will appear on the screen. The main menu allows you to select from several setup functions and one exit. Use arrow keys to select among the items and press  to accept or enter the submenu.

Main

The Main menu is the first screen that you will see when you enter the BIOS Setup Utility.

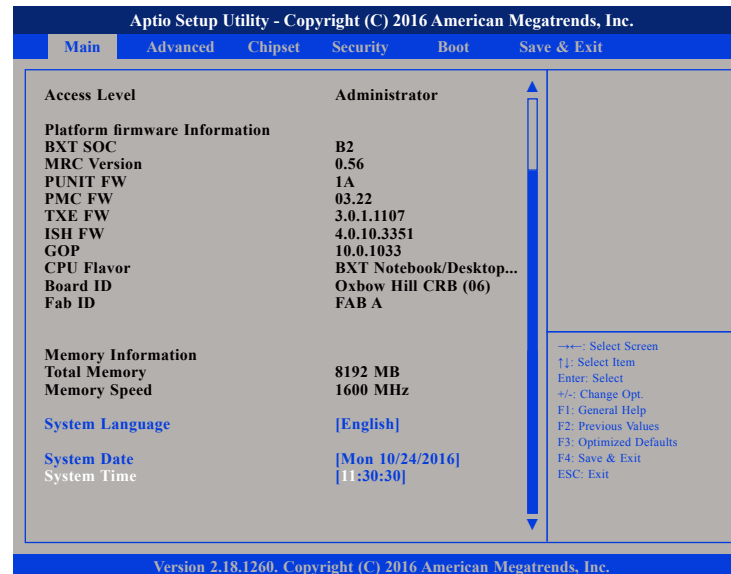
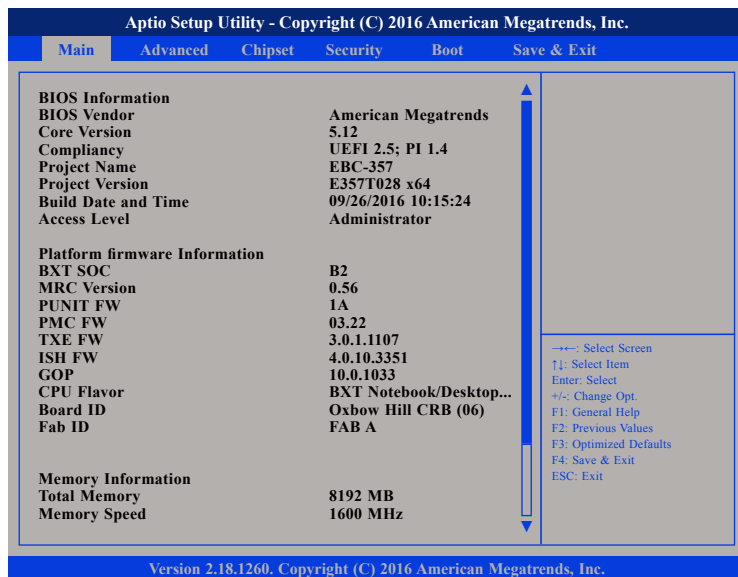

System Language

Selects the language of the system.

System Date

The date format is <day>, <month>, <date>, <year>. Day displays a day, from Monday to Sunday. Month displays the month, from January to December. Date displays the date, from 1 to 31. Year displays the year, from 1999 to 2099.

System Time

The time format is <hour>, <minute>, <second>. The time is based on the 24-hour military-time clock. For example, 1 p.m. is 13:00:00. Hour displays hours from 00 to 23. Minute displays minutes from 00 to 59. Second displays seconds from 00 to 59.

Advanced

The Advanced menu allows you to configure your system for basic operation. Some entries are defaults required by the system board, while others, if enabled, will improve the performance of your system or let you set some features according to your preference.



Setting incorrect field values may cause the system to malfunction.



Intel(R) I210 Gigabit Network Connection - NIC1

This section is used to configure network settings of the LAN controller.

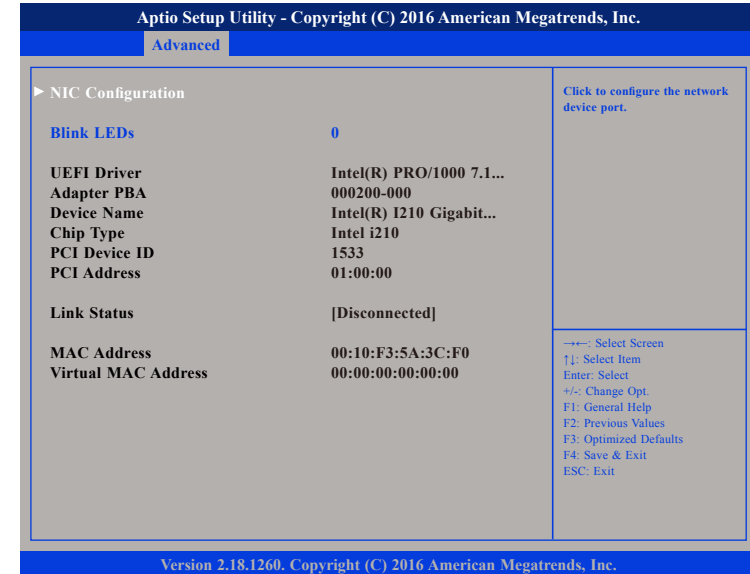

NIC Configuration

Enters the network configuration sub-menu of the network controller.

NIC Configuration

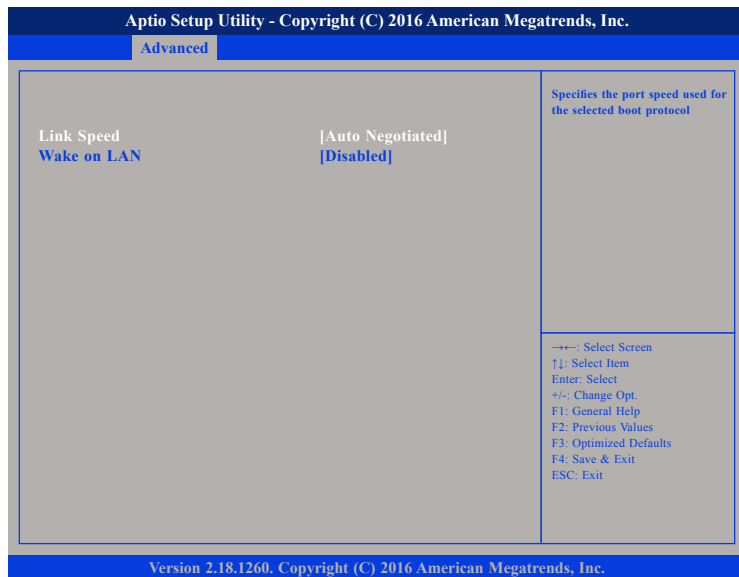

Link Speed

Specifies the link speed of the network interface.

Wake on LAN

Enables or disables Wake-on-LAN support.

Intel(R) I210 Gigabit Network Connection - NIC2

This section is used to configure network settings of the LAN controller.

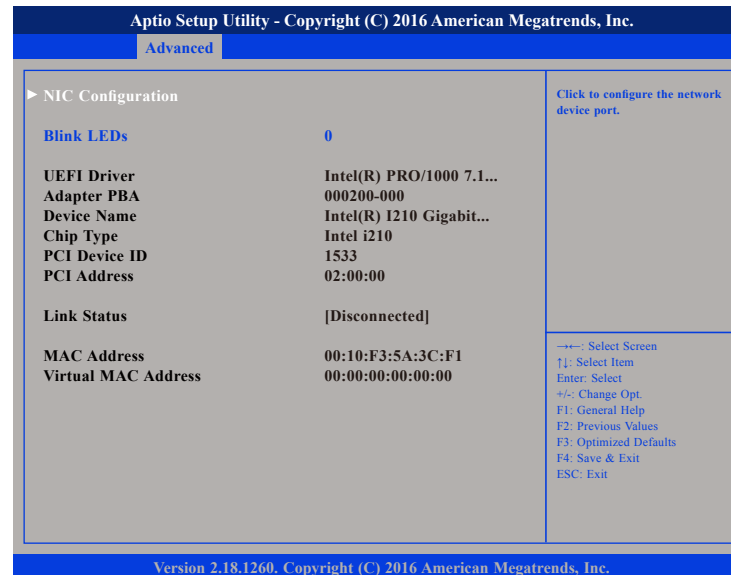

NIC Configuration

Enters the network configuration sub-menu of the network controller.

NIC Configuration

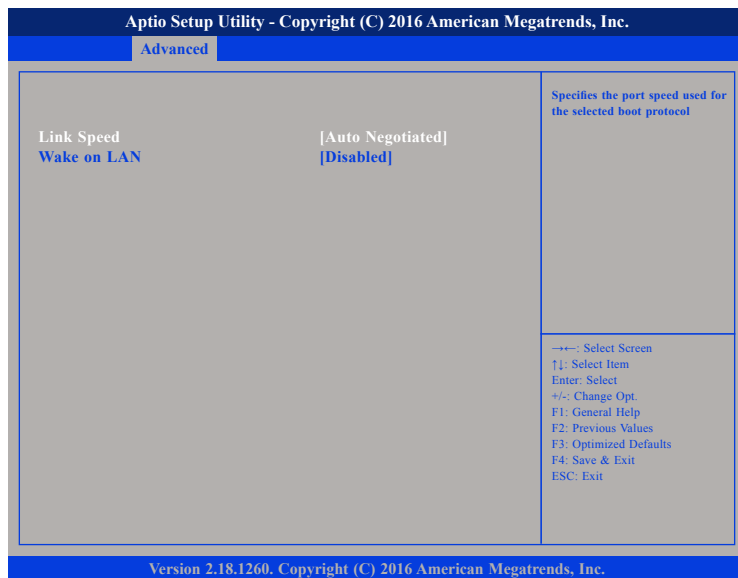

Link Speed

Specifies the link speed of the network interface.

Wake on LAN

Enables or disables Wake-on-LAN support.

Intel(R) I210 Gigabit Network Connection - NIC2

This section is used to configure network settings of the LAN controller.

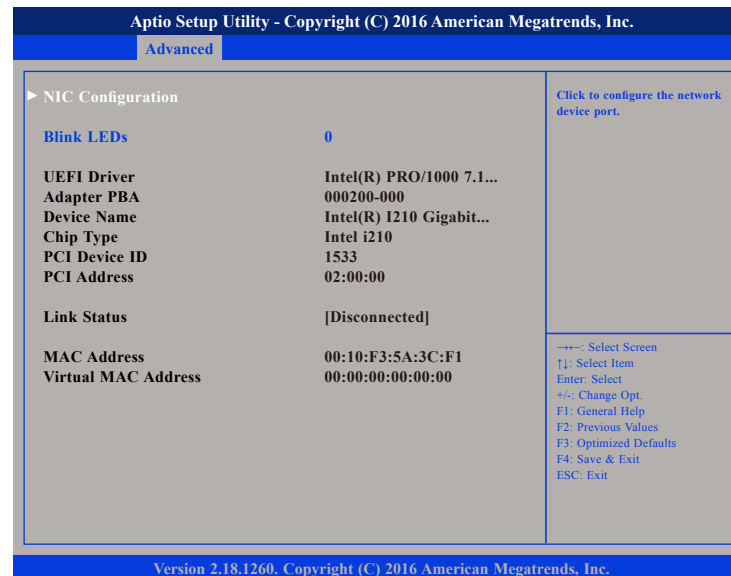

NIC Configuration

Enters the network configuration sub-menu of the network controller.

Driver Health

This section is used to check the health status of drivers and controllers.

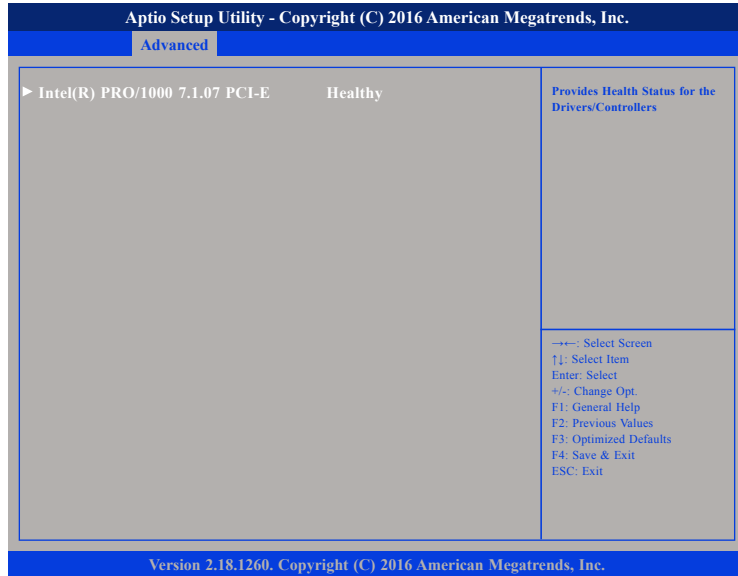

Intel® PRO/1000 7.1.07 PCI-E

Enters the health status menu of Intel® PRO/1000 7.1.07 PCI-E.

Intel® PRO/1000 7.1.07 PCI-E



Displays the health status of the controllers.

Trusted Computing

This section is used to configure Trusted Platform Module (TPM) settings.



Security Device Support

Enables or disables BIOS support for security device. O.S will not show Security Device. TCG EFI protocol and INT1A interface will not be available.

ACPI Settings

This section is used to configure ACPI settings.



Enable ACPI Auto Configuration

Enables or disables BIOS ACPI auto configuration.

Enable Hibernation

Enables or disables system ability to hibernate (OS/S4 Sleep State). This option may not be effective with some OS.

ACPI Sleep State

Select the highest ACPI sleep state the system will enter when the suspend button is pressed.

Lock Legacy Resources

Enables or disables system ability to prevent the operating system from modifying assignments for legacy resources (serial, parallel, and PS/2 ports).

IT8786 Super IO Configuration

This section is used to configure serial ports 1 to 5 of the super IO.

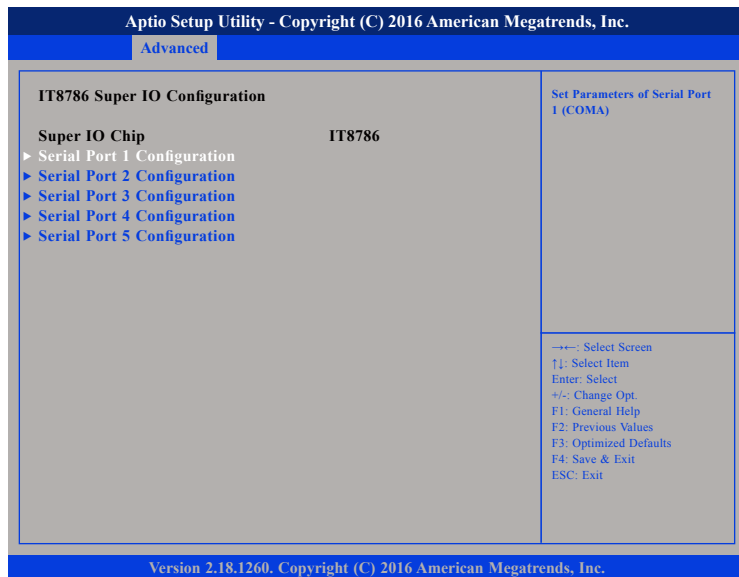

Super IO Chip

Displays the Super I/O chip used on the board.

Serial Port 1 Configuration

This section is used to configure serial port 1.

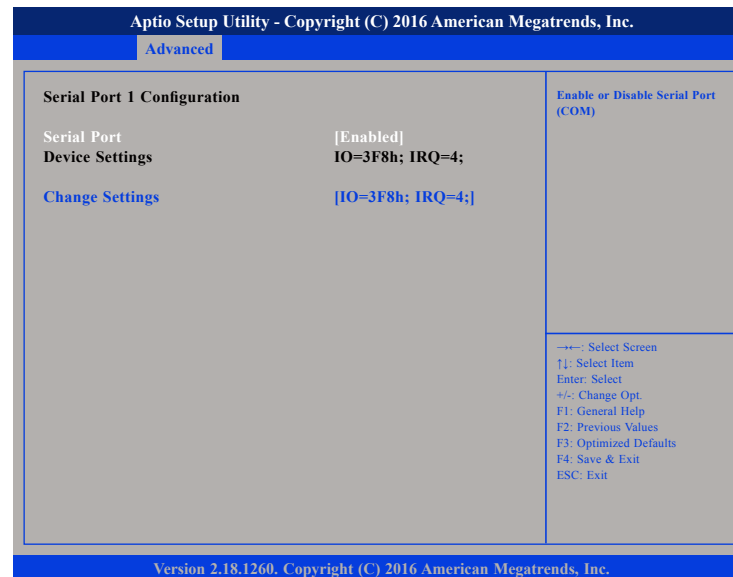

Serial Port

Enables or disables the serial port.

Change Settings

Selects an optimal setting for the Super IO device.

Serial Port 2 Configuration

This section is used to configure serial port 2.

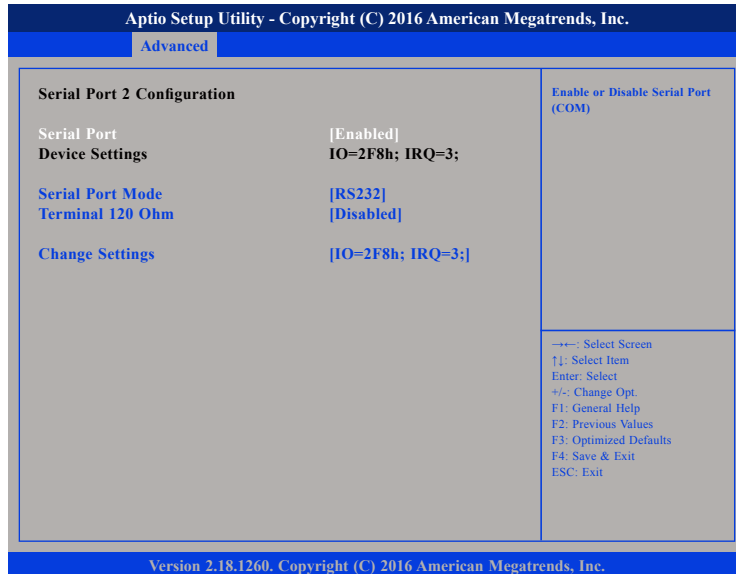

Serial Port

Enables or disables the serial port.

Serial Port Mode

Configures the serial port mode to RS232, RS422, RS485 or RS485 Auto.

Terminal 120 Ohm

Enables or disables serial port terminal resistance.

Change Settings

Selects an optimal setting for the Super IO device.

Serial Port 3 Configuration

This section is used to configure serial port 3.

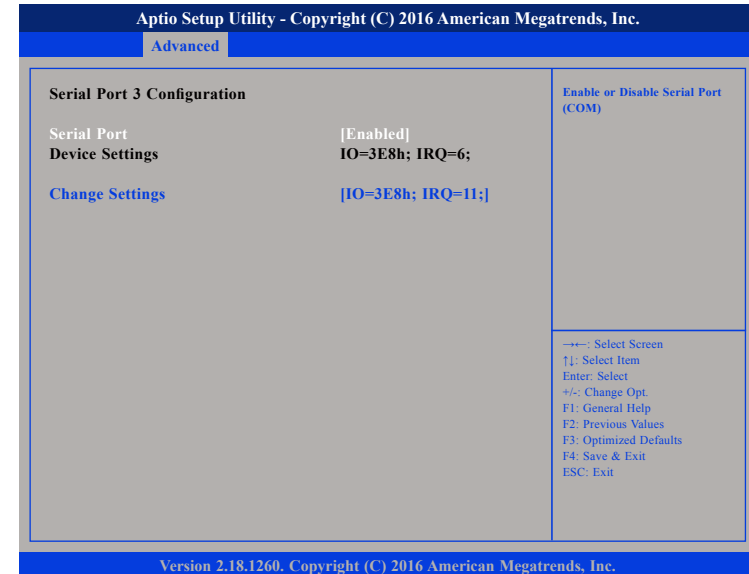

Serial Port

Enables or disables the serial port.

Change Settings

Selects an optimal setting for the Super IO device.

Serial Port 4 Configuration

This section is used to configure serial port 4.

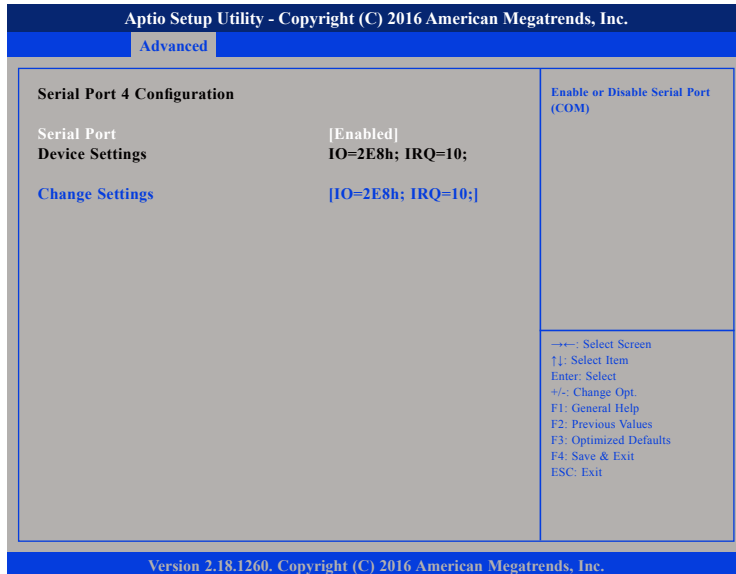

Serial Port

Enables or disables the serial port.

Change Settings

Selects an optimal setting for the Super IO device.

Serial Port 5 Configuration

This section is used to configure serial port 5.

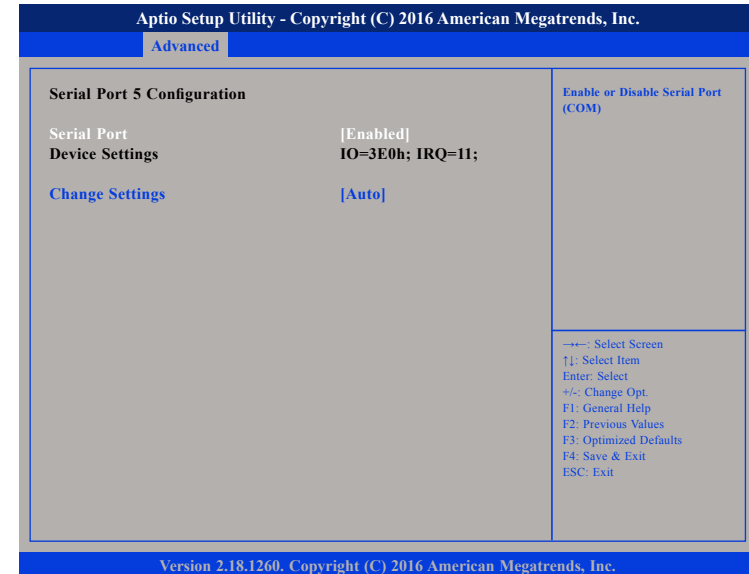

Serial Port

Enables or disables the serial port.

Change Settings

Selects an optimal setting for the Super IO device.

Hardware Monitor

This section is used to monitor hardware status such as temperature, fan speed and voltages.

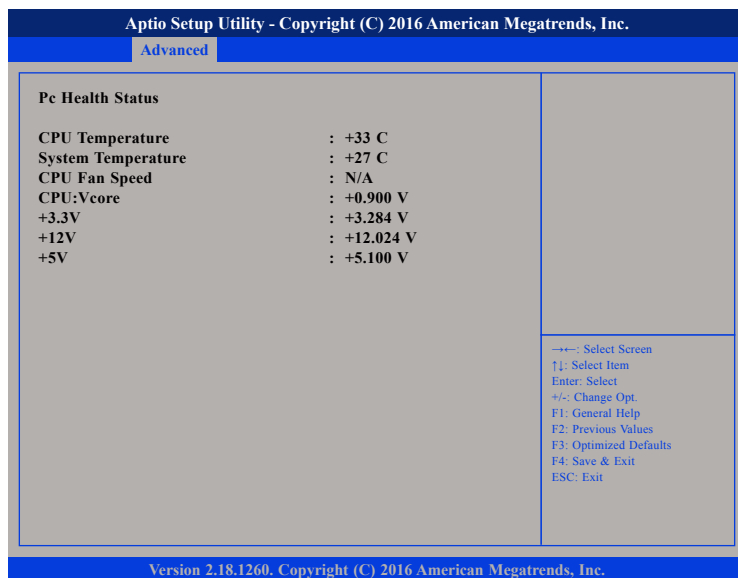

CPU Temperature

Detects and displays the current CPU temperature.

System Temperature

Detects and displays the current system temperature.

CPU FAN Speed

Detects and displays the CPU fan speed.

VCore to +5V

Detects and displays the output voltages.

CPU Configuration

This section is used to configure the CPU settings.



Active Processor Cores

Select the number of cores to enable in each processor package.

Intel® Virtualization Technology

When this field is set to Enabled, the VMM can utilize the additional hardware capabilities provided by Vanderpool Technology.

VT-d

Enables or disables VT-d function.

Bi-directional PROCHOT

Enables or disables bi-directional PROCHOT thermal throttling of the processor.

Thermal Monitor

Enables or disables thermal monitor of CPU.

Monitor Mwait

Enables or disables Monitor Mwait on the CPU.

P-STATE Coordination

Configures the P-STATE coordination type.

DTS

Enables or disables digital thermal sensor.

Socket 0 CPU Information

Display information on the CPU installed on socket 0.

Apfio Setup Utility - Copyright (C) 2016 American Megatrends, Inc.

Advanced

Socket 0 CPU Information	
Intel(R) Atom(TM) Processor E3950 @ 1.60GHz	
CPU Signature	506C9
Microcode Patch	1A
Max CPU Speed	1600 MHz
Min CPU Speed	800 MHz
Processor Cores	4
Intel HT Technology	Not Supported
Intel VT-x Technology	Supported
L1 Data Cache	24 kB x 4
L1 Code Cache	32 kB x 4
L2 Cache	1024 kB x 2
L3 Cache	Not Present

←: Select Screen
 ↑: Select Item
 Enter: Select
 +/-: Change Opt.
 F1: General Help
 F2: Previous Values
 F3: Optimized Defaults
 F4: Save & Exit
 ESC: Exit

Version 2.18.1260. Copyright (C) 2016 American Megatrends, Inc.

CPU Power Management

This section is used to configure the CPU power management settings.

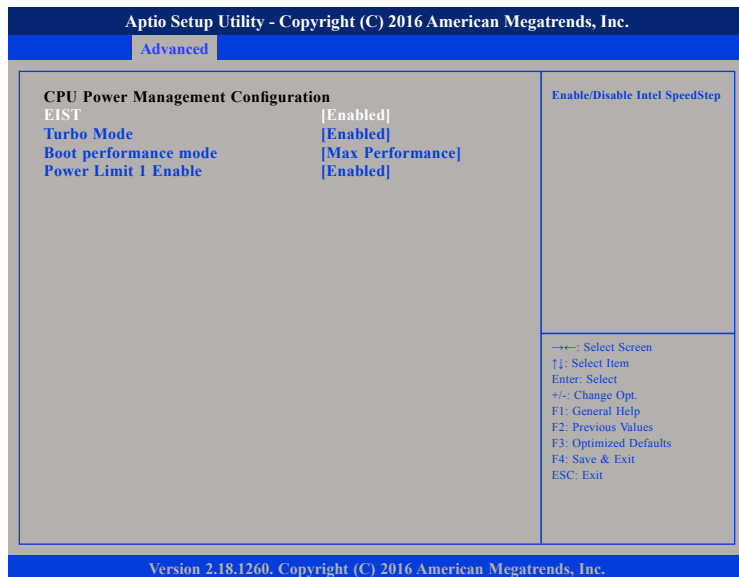

EIST

Enables or disables Intel® SpeedStep.

Turbo Mode

Enables or disables turbo mode.

Boot Performance Mode

Configures the performance mode of the CPU.

Power Limit 1 Enable

Enables or disables power limit.

AMI Graphic Output Protocol Policy

This section is used to configure the graphics controller settings.

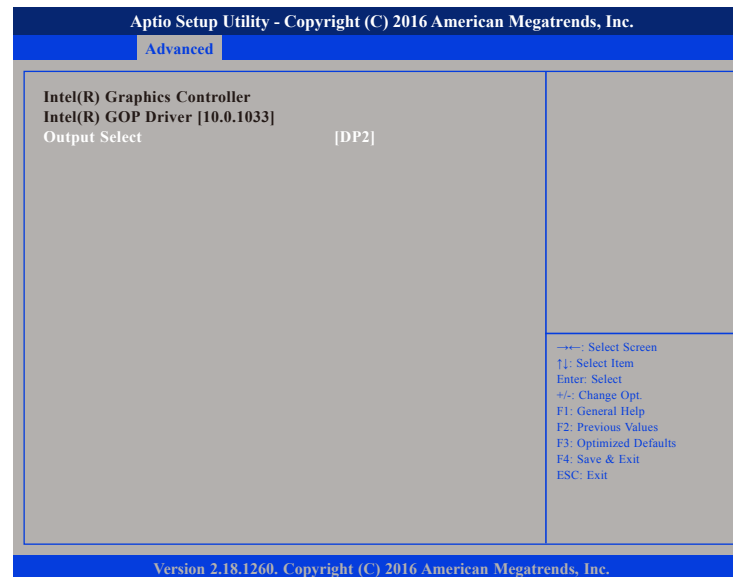

Output Select

Configures which display output to use upon boot.

Network Stack Configuration

This section is used to configure the network stack.

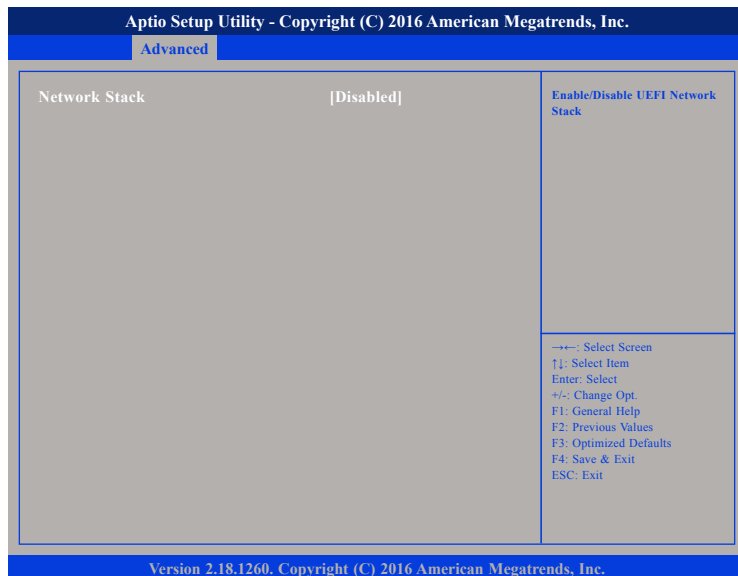

Network Stack

Enables or disables UEFI network stack.

CSM Configuration

This section is used to configure the compatibility support module features.



CSM Support

This field is used to enable or disable CSM support, if Auto option is selected, based on OS, CSM will be enabled or disabled automatically.

USB Configuration

This section is used to configure the USB.

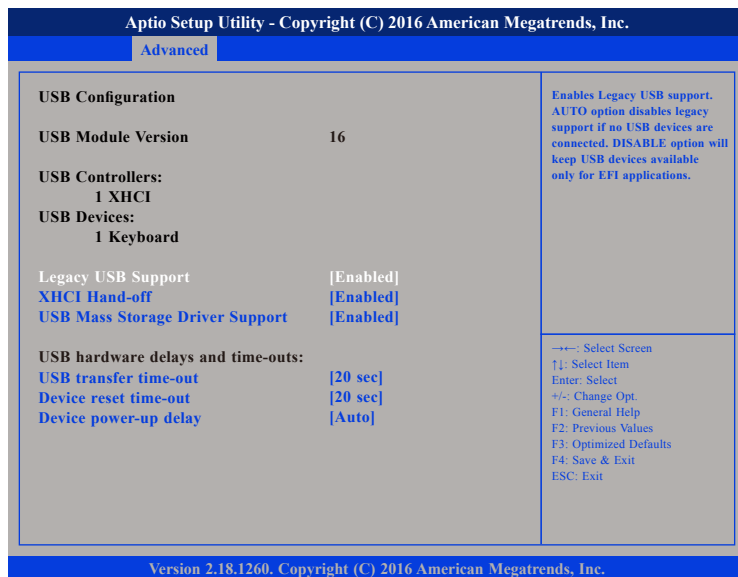

Legacy USB Support

Enable Enables Legacy USB.

Auto Disables support for Legacy when no USB devices are connected.

Disable Keeps USB devices available only for EFI applications.

XHCI Hand-off

This is a workaround for OSs that does not support XHCI hand-off. The XHCI ownership change should be claimed by the XHCI driver.

USB Mass Storage Driver Support

Enables or disables USB mass storage driver support.

USB Transfer Time-out

The time-out value for control, bulk, and Interrupt transfers.

Device Reset Time-out

Selects the USB mass storage device's start unit command timeout.

Device Power-up Delay

Maximum time the value will take before it properly reports itself to the Host Controller. "Auto" uses default value: for a Root port it is 100 ms, for a Hub port the delay is taken from Hub descriptor.

Platform Trust Technology

This section is used to configure TPM settings.



TPM

Enables or disables TPM support in the BIOS.

Security Configuration

This section is used to configure Intel® TXE settings.

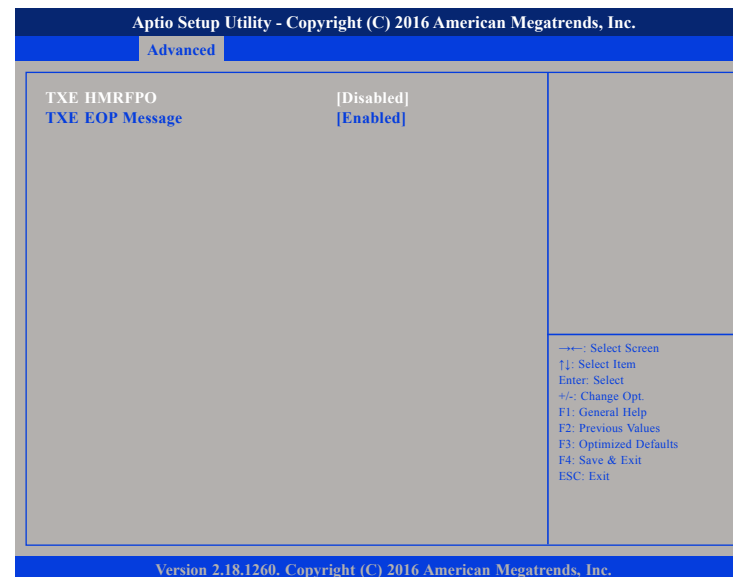

TXE HMRFP0

Enables or disables TXE HMRFP0.

TXE EOP Message

Enables or disables the option to send EOP messages before entering the OS.

Thermal

This section is used to configure thermal settings.

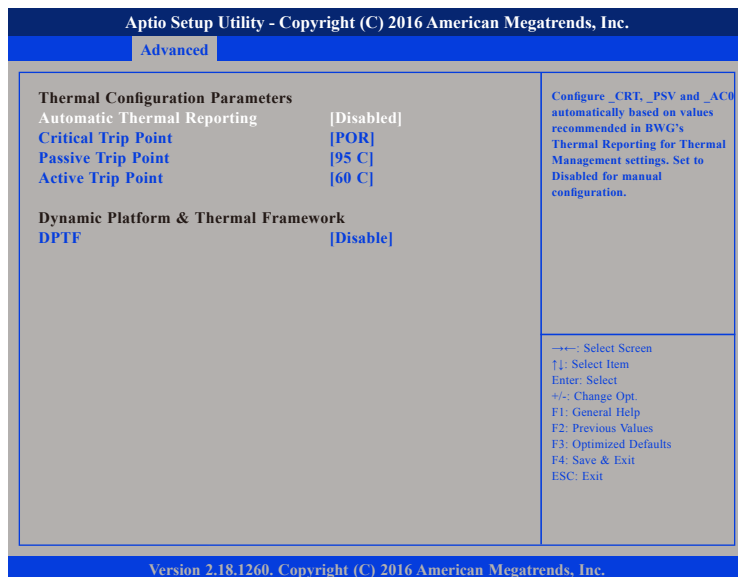

Automatic Thermal Reporting

This item is used to configure _CRT, _PSV and _AC0 automatically based on values recommended in BWG's Thermal Reporting for Thermal Management settings. Set to Disabled for manual configuration.

Critical Trip Point

This item is used to control the temperature of the ACPI Critical Trip Point – the point in which the OS will shut the system off. Please note that 100°C is the Plan of Record (POR) for all Intel mobile processors.

Passive Trip Point

This item is used to control the temperature of the ACPI Passive Trip Point – the point in which the OS will begin throttling the processor.

Active Trip Point

This item is used to control the temperature of the ACPI Active Trip Point – the point in which the OS will turn the processor fan on.

DPTF

Enables or disables Intel® Dynamic Platform and Thermal Framework (DPTF).

System Component

This section is used to configure system component settings.

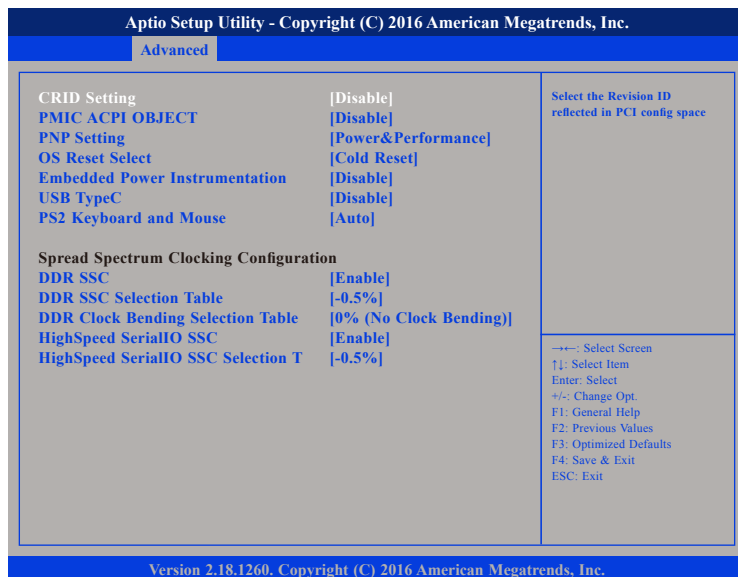

CRID Setting

Configures the Revision ID reflected in PCI config space.

PMIC ACPI OBJECT

Enables or disables PMIC ACPI device.

PNP Setting

Configures the mode of PnP. The options are Disable, Performance, Power and Power & Performance.

OS Reset Select

Configures the OS reset type. The options are Warm Reset and Cold Reset.

Embedded Power Instrumentation

Enables or disables the EPI feature.

USB TypeC

Enables or disables USB Type-C.

PS2 Keyboard and Mouse

Enables or disables PS2 keyboard and mouse.

DDR SSC

Enables or disables DDR Spread Spectrum Clocking configuration.

DDR SSC Selection Table

Configures the SSC setting for DDR Spread Spectrum.

DDR Clock Bending Selection Table

Configures the clock bending setting for DDR Spread Spectrum.

HighSpeed SerialIO SSC

Enables or disables high speed serial IO Spread Spectrum Clocking configuration.

HighSpeed SerialIO SSC Selection Table

Configures the SSC setting for high speed serial IO Spread Spectrum.

Debug Configuration

This section is used to configure system debug settings.



Kernel Debugger Enable

Enable or disable support for a kernel debugger (e.g. WinDBG). This mode configures the UART2 device for Legacy 16550 8-bit Addressing Mode and hides the device from the OS.

APEI BERT

Enables or disables APEI BERT.

ACPI Memory Debug

Enables or disables ACPI Memory Debug.

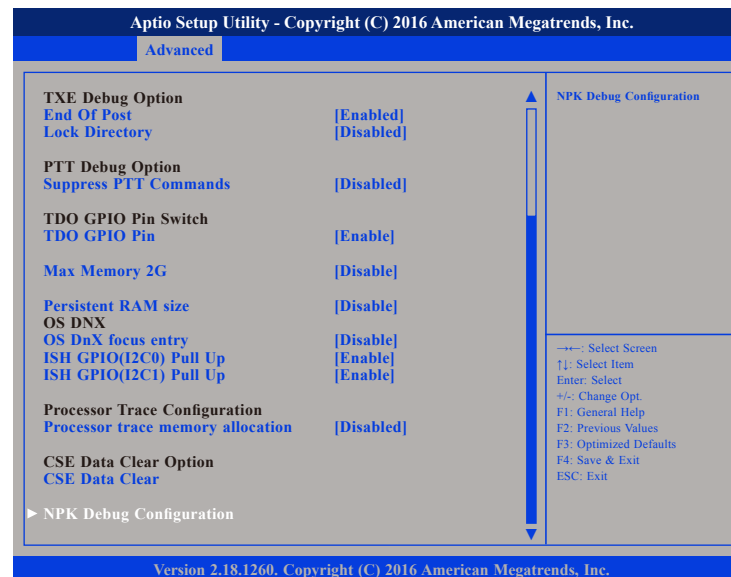

End of Post

Enables or disables the BIOS to send End of Post message.

Lock Directory

Enables or disables the BIOS to lock SETUP variable after End of Post.

Suppress PTT Commands

Enables or disables bypass of TPM2 commands submitting to PTT FW.

TDO GPIO Pin

Enables or disables TDO GPIO Pin. If Auto is selected, TDO will be disabled for A0 silicon only. For other steppings, TDO will be enabled.

Max Memory 2G

Enables or disables 2GB maximum memory support.

Persistent RAM Size

Configures the amount of main memory to be reserved for PRAM. The memory will be allocated right after MRC initialization and its location will be stored into ACPI table.

OS DnX Focus Entry

Enables or disables OS DnX focus entry.

ISH GPIO(I2C0) Pull Up

Enables or disables ISH GPIO I2C0 pull up.

ISH GPIO(I2C1) Pull Up

Enables or disables ISH GPIO I2C1 pull up.

Processor Trace Memory Allocation

Configures the processor trace memory region size from 4KB to 128MB.

NPK Debug Configuration

The screenshot shows the 'Advanced' tab of the Aptio Setup Utility. The title bar reads 'Aptio Setup Utility - Copyright (C) 2016 American Megatrends, Inc.' and the current tab is 'Advanced'. The main area contains a list of configuration options:

North Peak Enable	[Auto]	North Peak Function Enable
FW Trace Enable	[Enable]	
FW Trace Destination	[PTI]	
NPK Recovery Dump	[Disable]	
Memory Region 0 Buffer Size	[None]	
Memory Region 0 Buffer WrapAround	[Wrap]	
Memory Region 1 Buffer Size	[None]	
Memory Region 1 Buffer WrapAround	[Wrap]	
PTI Mode	[X4]	
PTI Training	[Off]	
PTI Speed	[Quarter Speed]	
Punit Message Level	[LEVEL LOW]	
PMC Message Level	[LEVEL LOW]	

At the bottom right, there is a legend for navigation keys:

- ←→: Select Screen
- ↑↓: Select Item
- Enter: Select
- +/-: Change Opt.
- F1: General Help
- F2: Previous Values
- F3: Optimized Defaults
- F4: Save & Exit
- ESC: Exit

The footer of the screen reads 'Version 2.18.1260. Copyright (C) 2016 American Megatrends, Inc.'

North Peak Enable

Enables or disables north peak function.

FW Trace Enable

Enables or disables FW trace function.

FW Trace Destination

Configures the destination of FW trace.

NPK Recovery DUMP

Enables or disables the NPK recovery dump feature.

Memory Region 0 Buffer Size

Configures the buffer size for memory region 0.

Memory Region 0 Buffer WrapAround

Enables or disables buffer wrap around for memory region 0.

Memory Region 1 Buffer Size

Configures the buffer size for memory region 1.

Memory Region 1 Buffer WrapAround

Enables or disables buffer wrap around for memory region 1.

Punit Message Level

Configures the punit message output verbosity level. LEVEL DEFAULT means IAFW will not change verbosity level.

PMC Message Level

Configures the PMC message output verbosity level.

RC ACPI Settings

This section is used to configure RC ACPI settings.

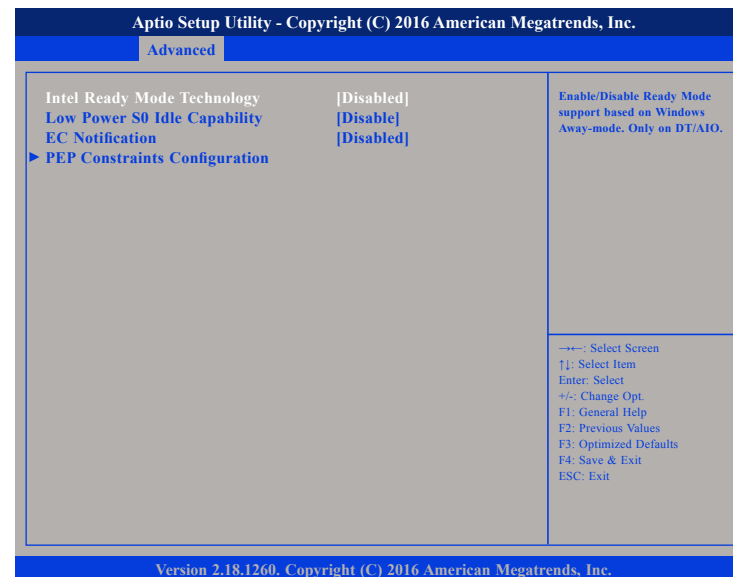

Intel Ready Mode Technology

Enables or disables Intel Ready Mode Technology support based on Windows away-mode. Only available on DT/AIO.

Low Power S0 Idle Capability

Enables or disables ACPI Low Power Idle Capability (mutually exclusive with Smart connect). Also updates the Platform S0ix Capability support in IGD OpRegion.

EC Notification

Enables or disables the sending of EC notification of Low Power S0 Idle State.

PEP Constraints Configuration

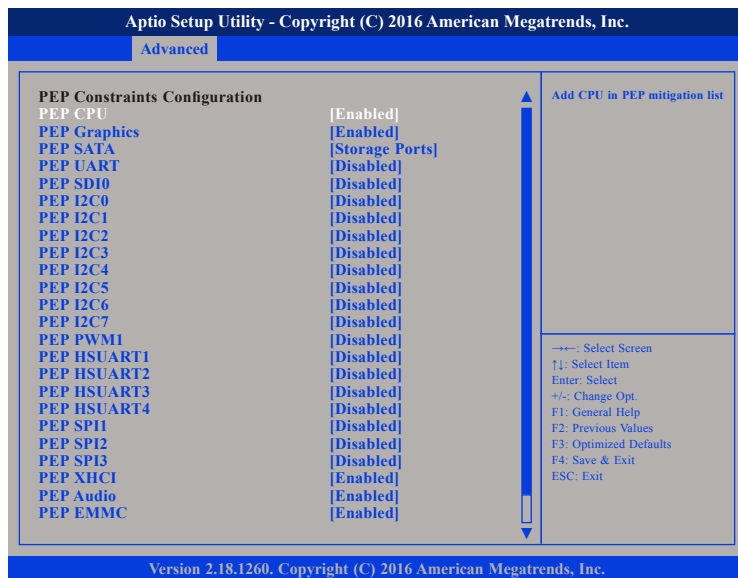

PEP CPU/Graphics/SATA/UART/SDIO/PWM1

Enables or disables CPU, Graphics, Storage Device, UART, SDIO and PWM1 in the PEP mitigation list.

PEP I2C0 to PEP I2C7

Enables or disables PEP I2C0 to PEP I2C7 in the PEP mitigation list.

PEP HSUART1 to PEP HSUART4

Enables or disables PEP HSUART1 to PEP HSUART4 in the PEP mitigation list.

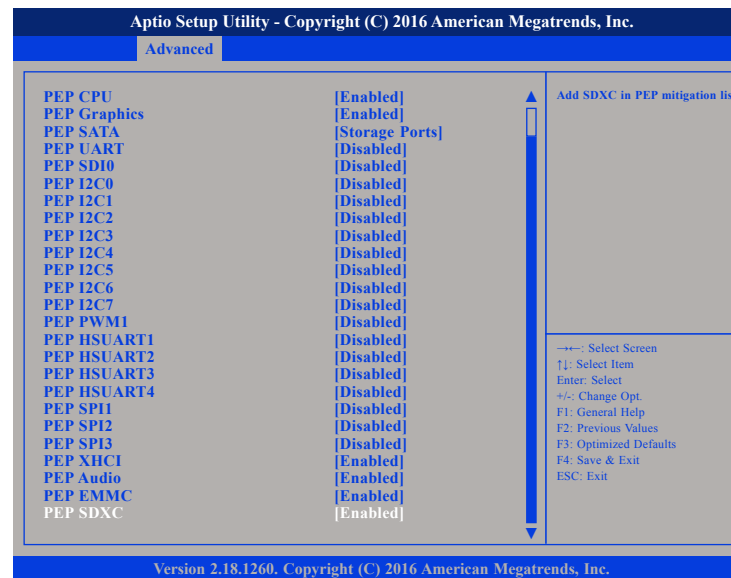

PEP SPI1 to PEP SPI3

Enables or disables PEP SPI1 to PEP SPI3 in the PEP mitigation list.

PEP XHCI/Audio/EMMC/SDXC

Enables or disables XHCI, Audio, EMMC and SDXC in the PEP mitigation list.

RTD3 Settings

This section is used to configure RTD3 settings.



RTD3 Support

Enables or disables runtime D3 support.

Consolidated Power Resource

Enables or disables 1 power resource for all power gated devices except the network device. Use this for Modern Standby test.

P-state Capping

Enables or disables _PPC and the sending of ACPI notification.

USB Port 1 and USB Port 2

Configures the speed of USB ports 1 and 2.

I2C0 Sensor Hub

Enables or disables RTD3 support for I2C0 sensor hub.

ZPODD

Enables or disables Zero Power ODD option. Only applicable for WhiteTipMountain1 and AdenHills with ZPODD feature rework.

USB Camera

Enables or disables USB Camera option. Only applicable for WhiteTipMountain1, AdenHills and Sawtoothpeak with USB feature rework.

SATA Port 1 and SATA Port 2

Enables or disables the control of RTD3 functionality of SATA ports 1 and 2.

MiniCard SATA Port3

Configures the MiniCard type for SATA port 3.

Chipset

This section gives you functions to configure the system based on the specific features of the chipset. The chipset manages bus speeds and access to system memory resources.

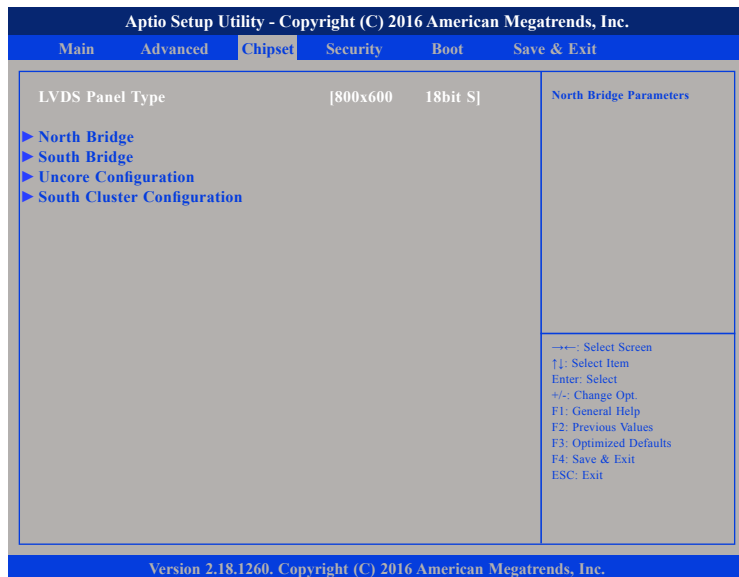

LVDS Panel Type

Configures the LVDS panel resolution.

North Bridge

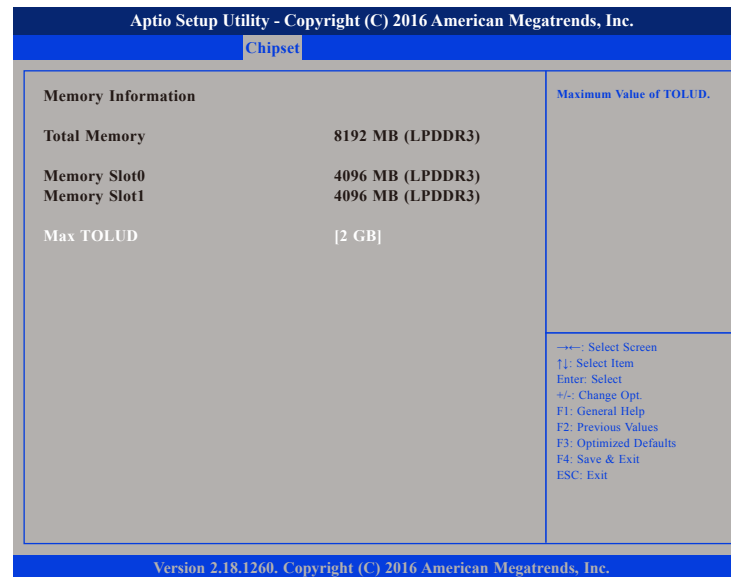

Max TOLUD

Configures the maximum value of TOLUD.

South Bridge

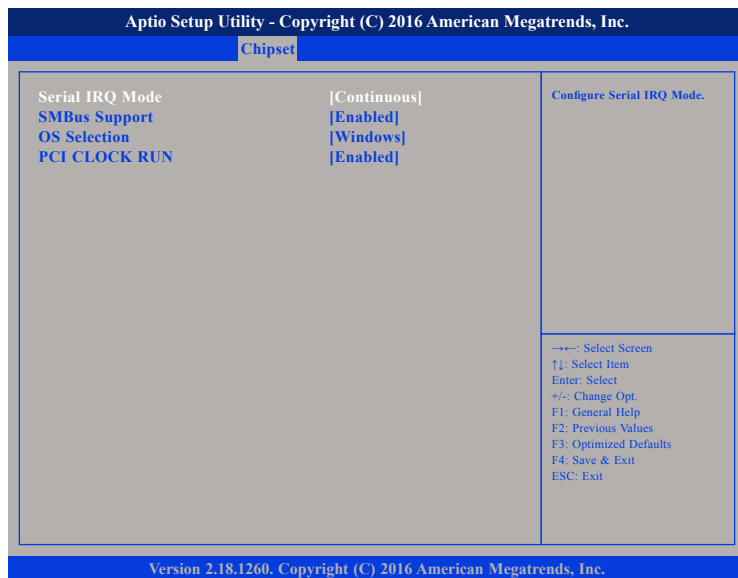

Serial IRQ Mode

Configures the serial IRQ mode.

SMBus Support

Enables or disables SMBus support.

OS Selection

Configures the target OS. The options are Windows, Android, Windows 7 and Intel Linux.

PCI CLOCK RUN

Enables or disables CLKRUN# logic to stop PCI clocks.

Uncore Configuration

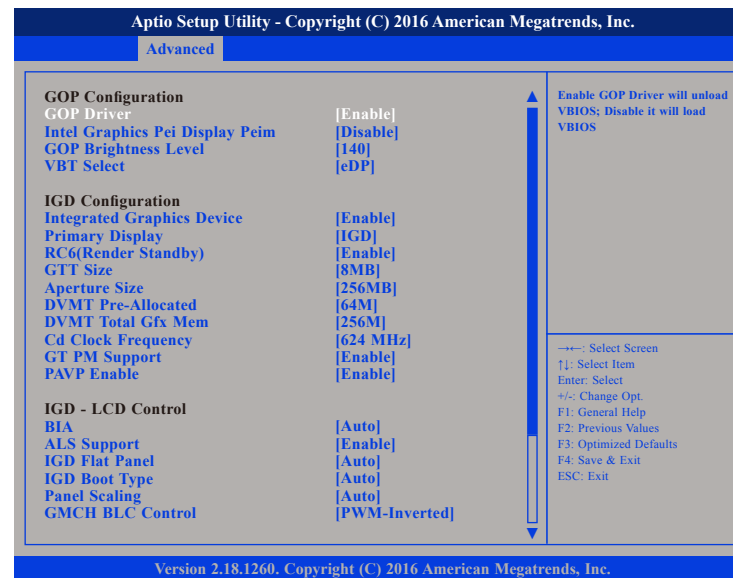

GOP Driver

Enables or disables the GOP driver. Enabling it will unload the VBIOS while disabling it will load the VBIOS.

Intel Graphics Pei Display Peim

Enables or disables Pei (Early) display.

GOP Brightness Level

Configures the GOP brightness level.

VBT Select

Configures the VBT for the GOP driver.

Uncore Configuration Cont.



Integrated Graphics Device

Enables or disables the integrated graphics device (IGD).

Primary Display

Configures which IGD/PCI graphics device is used as the primary display.

RC6 (Render Standby)

Enables or disables render standby support. RC6 should be enabled if S0ix is enabled. This item will be read only if S0ix is enabled.

GTT Size

Configures the GTT size.

Aperture Size

Configures the aperture size.

DVMT Pre-Allocated

Configures the DVMT 5.0 pre-allocated (fixed) graphics memory size used by the internal graphics device.

DVMT Total Gfx Mem

Configures the DVMT5.0 Total Graphic Memory size used by the internal graphics device.

Cd Clock Frequency

Configures the highest Cd clock frequency supported by the platform.

GT PM Support

Enables or disables GT PM support.

PAVP Enable

Enables or disables PAVP.

BIA

Configures the BIA level. The options are Auto, Disabled and Level 1 to Level 5.

ALS Support

Enables or disables ALS support. Only valid for ACPI.

IGD Flat Panel

Configures the resolution of the IGD flat panel.

IGD Boot Type

Configures the display interface to use for the integrated graphics device when system boots.

Panel Scaling

Configures the image scale. The options are Auto, Centering and Stretching.

GMCH BLC Control

Configures the behavior of the backlight.

Memory Scrambler

Enables or disables memory scrambler support.

IPU Enable/Disable

Enables or disables the IPU device.

South Cluster Configuration



HD-Audio Configuration



HD-Audio Support

Enables or disables HD-Audio support.

HD-Audio DSP

Enables or disables HD-Audio DSP.

HD-Audio CSME Memory Transfers

Configures the HD-Audio CSME memory transfers to VC0 or VC2.

HD-Audio Host Memory Transfers

Configures the HD-Audio host memory transfers to VC0 or VC2.

HD-Audio I/O Buffer Ownership Select

Configures the ownership of the HD-Audio I/O buffer.

HD-Audio BIOS Config Lock Down

Enables or disables HD-Audio BIOS config lockdown.

HD-Audio Clock Gating

Enables or disables HD-Audio BIOS clock gating.

HD-Audio Power Gating

Enables or disables HD-Audio BIOS power gating.

HD-Audio PME

Enables or disables HD-Audio PME.

HD Audio Link Frequency

Configures the frequency of the HD-Audio link. Applicable only if HDA codec supports the selected frequency.

iDisplay Link Frequency

Configures the frequency of the iDisplay link. Applicable only if iDisp codec supports the selected frequency.

GMM Configuration



GMM Support

Enables or disables GMM support.

GMM Clock Gate - PGCB Clock Trunk

Enables or disables GMM Clock Gate - PGCB Clock Trunk.

GMM Clock Gate - Sideband

Enables or disables GMM Clock Gate - Sideband.

GMM Clock Gate - Sideband Clock Trunk

Enables or disables GMM Clock Gate - Sideband Clock Trunk.

GMM Clock Gate - Sideband Clock Partition

Enables or disables GMM Clock Gate - Sideband Clock Partition.

GMM Clock Gate - Core

Enables or disables GMM Clock Gate - Core.

GMM Clock Gate - DMA Engine

Enables or disables GMM Clock Gate - DMA Engine.

GMM Clock Gate - Register Access

Enables or disables GMM Clock Gate - Register Access.

GMM Clock Gate - Host Interface

Enables or disables GMM Clock Gate - Host Interface.

GMM Clock Gate - Partition

Enables or disables GMM Clock Gate - Partition.

GMM Clock Gate - Trunk

Enables or disables GMM Clock Gate - Trunk.

GMM Power Gate - HW Autonomous

Enables or disables GMM Power Gate - HW Autonomous.

ISH Configuration



ISH Controller

Enables or disables Integrated Sensor Hub (ISH) device.

LPSS Configuration

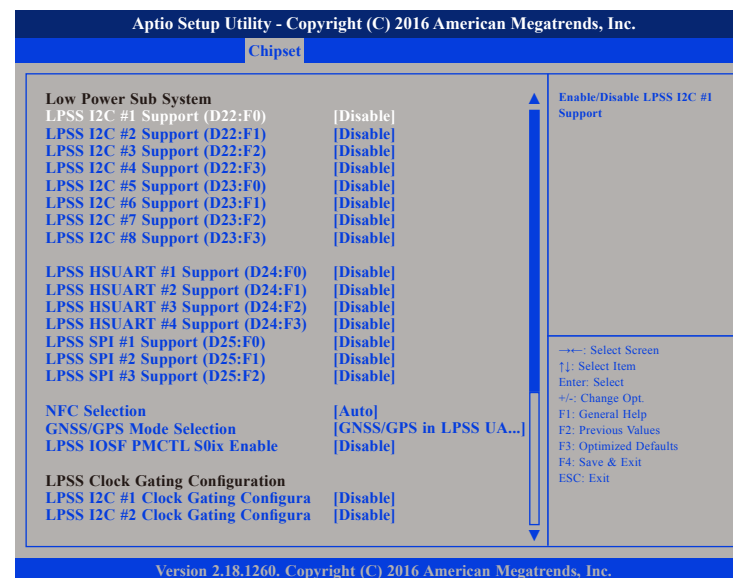

LPSS I2C #1 Support to LPSS I2C #8 Support

Disables or configures LPSS I2C #1 to LPSS I2C #8 to PCI or ACPI mode.

LPSS HSUART #1 Support to LPSS HSUART #4 Support

Disables or configures LPSS HSUART #1 to LPSS HSUART #4 to PCI or ACPI mode.

LPSS SPI #1 Support to LPSS SPI #3 Support

Disables or configures LPSS SPI #1 to LPSS SPI #3 to PCI or ACPI mode.

LPSS Configuration Cont.



LPSS I2C #1 to LPSS I2C #8 Clock Gating Configuration

Enables or disables LPSS I2C #1 to LPSS I2C #8 Clock Gating.

LPSS HSUART #1 to LPSS HSUART #4 Clock Gating Configuration

Enables or disables LPSS HSUART #1 to LPSS HSUART #4 Clock Gating.

LPSS SPI #1 to LPSS SPI #3 Clock Gating Configuration

Enables or disables LPSS SPI #1 to LPSS SPI #3 Clock Gating.

NFC Selection

Configures which NFC to use. Auto will make the selection based on BoardID.

GNSS/GPS Mode Selection

Configures which GNSS/GPS mode to use. Auto will make the selection based on BoardID.

LPSS IOSF PMCTL S0ix Enable

Enables or disables LPSS IOSF PMCTL register S0ix bits.

PCI Express Root Port 3 to Port 6

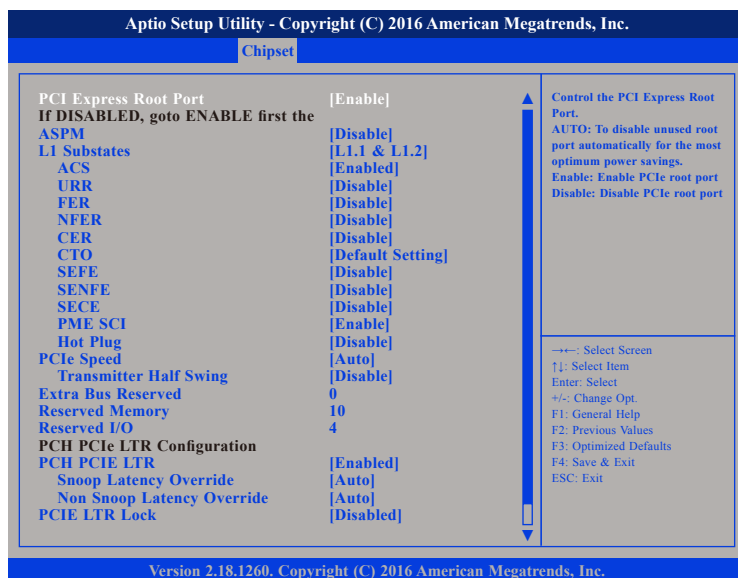

PCI Express Root Port

Enables or disables the PCI Express root port. Selecting Auto will disable unused root port automatically for the most optimum power savings.

ASPM

Configures the ASPM level.

L1 Substates

Configures the L1 Substates settings.

ACS

Enables or disables Access Control Services Extended capability.

URR

Enables or disables PCI Express Unsupported Request Reporting.

FER

Enables or disables PCI Express Device Fatal Error Reporting.

NFER

Enables or disables PCI Express Device Non-Fatal Error Reporting.

CER

Enables or disables PCI Express Device Correctable Error Reporting.

CTO

Configures the PCI Express Completion Timer T0.

SEFE

Enables or disables PCI Express System Error on Fatal Error.

SENF

Enables or disables Root PCI Express System Error on Non-Fatal Error.

SECE

Enables or disables Root PCI Express System Error on Correctable Error.

PME SCI

Enables or disables PCI Express PME SCI.

PCI Express Root Port 3 to Port 6 Cont.

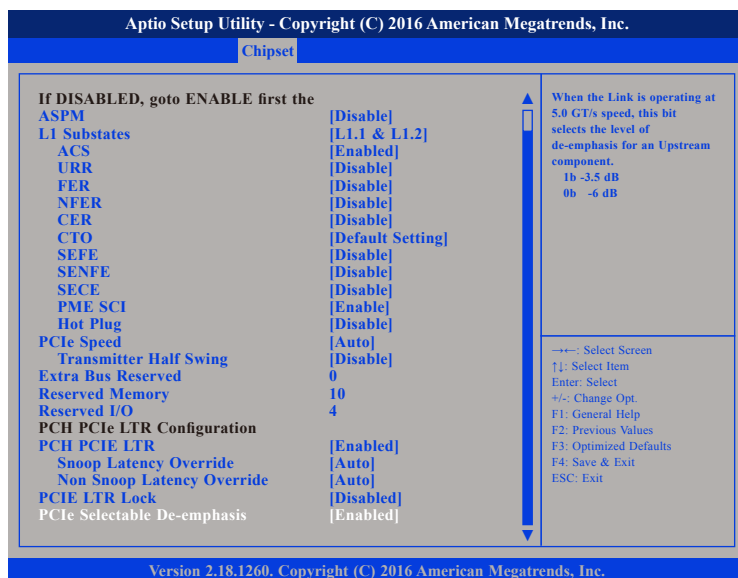

Hot Plug

Enables or disables PCI Express Hot-Plug support.

PCIe Speed

Configures the speed of the PCI Express port.

Transmitter Half Swing

Enables or disables Transmitter Half Swing mode.

PCH PCIe LTR

Enables or disables PCH PCIe Latency Reporting.

Snoop Latency Override

Snoop latency override for PCH PCIe.

Disabled	Disable override.
Manual	Manually enter override values.
Auto (default)	Maintain default BIOS flow.

Non Snoop Latency Override

Non-Snoop latency override for PCH PCIe.

Disabled	Disable override.
Manual	Manually enter override values.
Auto (default)	Maintain default BIOS flow.

PCIe LTR Lock

Enables or disables PCIe LTR Configuration Lock.

PCIe Selectable De-emphasis

When the Link is operating at 5.0 GT/s speed, this bit selects the level of de-emphasis for an upstream component.

1b	-3.5 dB
0b	-6 dB

SATA Drives

This section is used to configure the SATA drives.



Chipset SATA

Enables or disables the SATA controller chipset. The SATA controller chipset supports the 2 black internal SATA ports (up to 3Gb/s supported per port).

SATA Test Mode

Enables or disables SATA test mode.

Aggressive LPM Support

Enables or disables PCH to aggressively enter link power state.



SATA Mode Selection

Configures the SATA mode.

- AHCI This option configures the Serial ATA drives to use AHCI (Advanced Host Controller Interface). AHCI allows the storage driver to enable the advanced Serial ATA features which will increase storage performance.
- RAID This option allows you to create RAID or Intel Matrix Storage configuration on Serial ATA devices.

Port 0 and Port 1

Enables or disables SATA port 0 and port 1.

SATA Port 0 and Port 1 Hot Plug Capability

Enables or disables hot plugging feature on SATA port 0 and port 1.

Mechanical Presence Switch

Enables or disables reporting of whether port 0 and port 1 have a mechanical presence switch. Note: Requires hardware support.

Spin Up Device

Enables or disables staggered spin up on devices connected to SATA port 0 and port 1.

SATA Port 0 and Port 1 DevSlp

Enables or disables SATA port 0 and port 1 DevSlp. Before enabling DevSlp, board rework is needed.

DIT0 Configuration

Enables or disables DIT0 configuration for SATA port 0 and port 1.

SCC Configuration

This section is used to configure SCC settings.

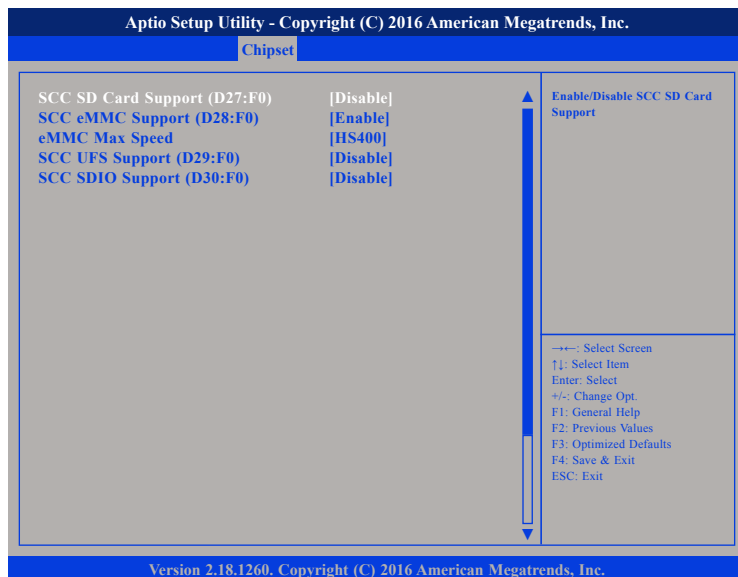

SCC UFS Support (D29:F0)

Enables or disables UFS SDIO support.

SCC SDIO Support (D30:F0)

Enables or disables SCC SDIO support.

SCC SD Card Support (D27:F0)

Enables or disables SCC SD card support.

SCC eMMC Support (D28:F0)

Enables or disables SCC eMMC support.

eMMC Max Speed

Configures the eMMC maximum allowed speed.

USB Configuration

This section is used to configure the USB settings.

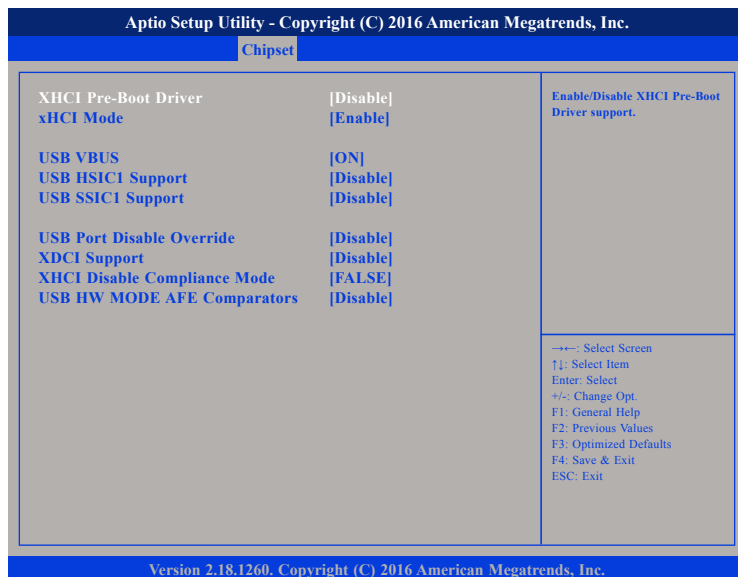

XHCI Pre-Boot Driver

Enables or disables XHCI Pre-Boot driver support.

xHCI Mode

Enables or disables XHCI mode. Once disabled, XHCI controller function will be disabled and all the USB devices will not be detectable and usable during boot up and in OS. Please do not disable it unless for debugging purposes.

USB VBUS

Enables or disables USB VBUS. Please set VBUS to ON in HOST mode and OFF in OTG device mode.

USB HSIC1 Support

Enables or disables USB HSIC1.

USB SSIC1 Support

Enables or disables USB SSIC1.

USB Port Disable Override

Enables or disables the USB port from reporting a device connection to the controller.

XDCI Support

Disables or enables XDCI support.

XHCI Disable Compliance Mode

Enables or disables XHCI link compliance mode. Setting FALSE will not disable link compliance mode, while setting TRUE will disable link compliance mode.

USB HW MODE AFE Comparators

Enables or disables USB HW MODE AFE Comparators.

Miscellaneous Configuration

This section is used to configure other miscellaneous settings.



High Precision Timer

Enables or disables high precision event timer.

8254 Clock Gating

Enables or disables 8254 clock gating.

State After G3

Configures the power state when power is re-applied after a power failure (G3 state).

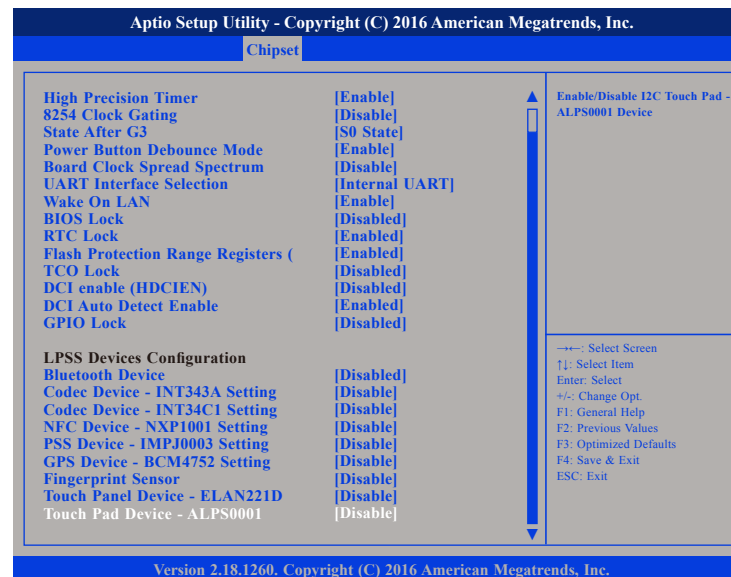

Power Button Debounce Mode

Enables or disables interrupt when PWRBTN# is asserted.

Board Clock Spread Spectrum

Enables or disables Clock Chip Spread Spectrum feature.

UART Interface Selection

Configures which UART interface to use.

Wake On LAN

Enables or disables the Wake on LAN feature.

BIOS Lock

Enables or disables the SC BIOS Lock feature. Required to be enabled to ensure SMM protection of flash.

RTC Lock

Enables or disables lock bytes 38h-3Fh in the lower/upper 128-byte bank of RTC RAM.

Flash Protection Range Registers (FPRR)

Enables or disables Flash Protection Range Registers.

TCO Lock

Enables or disables TCO and Lockdown TCO.

DCI enable (HDCIEN)

Enables or disables DCI. When DCI is enabled, it is taken as user consent to enable the DCI which allows debugging over the USB3 interface. When DCI is disabled, the host control will not be enabling the DCI feature.

DCI Auto Detect Enable

Enables or disables DCI auto detection. When enabled, DCI will be activated and detection for DCI being connected will be initiated during BIOS post.

GPIO Lock

Enables or disables GPIO Pad Configuration Lock for security.

Bluetooth Device

Enables or disables the Bluetooth device.

Codec Device - INT343A Setting

Enables or disables I2S Codec - INT343A Device.

Codec Device - INT34C1 Setting

Enables or disables I2S Codec - INT34C1 Device.

NFC Device - NXP1001 Setting

Enables or disables I2C NFC - NXP1001 Device.

PSS Device - IMPJ0003 Setting

Enables or disables I2C PSS - IMPJ0003 Device.

GPS Device - BCM4752 Setting

Enables or disables UART GPS - BCM4752 Device.

Fingerprint Sensor

Configures the HID to enable fingerprint sensor.

Touch Panel Device - ELAN221D

Enables or disables I2C Touch Panel - ELAN221D Device.

Touch Pad Device - ALPS0001

Enables or disables I2C Touch Pad - ALPS0001 Device.

Security

Aptio Setup Utility - Copyright (C) 2016 American Megatrends, Inc.					
Main	Advanced	Chipset	Security	Boot	Save & Exit
<p>Password Description</p> <p>If ONLY the Administrator's password is set, then this only limits access to Setup and is only asked for when entering Setup. If ONLY the User's password is set, then this is a power on password and must be entered to boot or enter Setup. In Setup the User Will have Administrator rights. The password length must be in the following range: Minimum length 3 Maximum length 20</p> <p>Setup Administrator Password User Password</p>		<p>Set Setup Administrator Password</p>			
		<p>→←: Select Screen ↑↓: Select Item Enter: Select +/-: Change Opt. F1: General Help F2: Previous Values F3: Optimized Defaults F4: Save & Exit ESC: Exit</p>			
Version 2.18.1260. Copyright (C) 2016 American Megatrends, Inc.					

Setup Administrator Password

Select this to reconfigure the administrator's password.

User Password

Select this to reconfigure the user's password.

Boot

Aptio Setup Utility - Copyright (C) 2016 American Megatrends, Inc.					
Main	Advanced	Chipset	Security	Boot	Save & Exit
<p>Boot Configuration</p> <p>Setup Prompt Timeout 1 Bootup NumLock State [On] Quiet Boot [Disabled]</p> <p>Boot Option Priorities</p> <p>Boot Option #1 [UEFI: Built-in EFI . . .] Fast Boot [Disable]</p> <p>New Boot Option Policy [Default]</p>		<p>Number of seconds to wait for setup activation key. 65535(0xFFFF) means indefinite waiting.</p>			
		<p>→←: Select Screen ↑↓: Select Item Enter: Select +/-: Change Opt. F1: General Help F2: Previous Values F3: Optimized Defaults F4: Save & Exit ESC: Exit</p>			
Version 2.18.1260. Copyright (C) 2016 American Megatrends, Inc.					

Setup Prompt Timeout

Configures the number of seconds to wait for setup activation key. 65535 (0xFFFF) means indefinite waiting.

Bootup NumLock State

This allows you to determine the default state of the numeric keypad. By default, the system boots up with NumLock on wherein the function of the numeric keypad is the number keys. When set to Off, the function of the numeric keypad is the arrow keys.

Quiet Boot

Enabled Displays OEM logo instead of the POST messages.
 Disabled Displays normal POST messages.

Boot Option Priorities

Adjust the boot sequence of the system. Boot Option #1 is the first boot device that the system will boot from, next will be #2 and so forth.

Fast Boot

When enabled, the BIOS will shorten or skip some check items during POST. This will decrease the time needed to boot the system.

Save & Exit

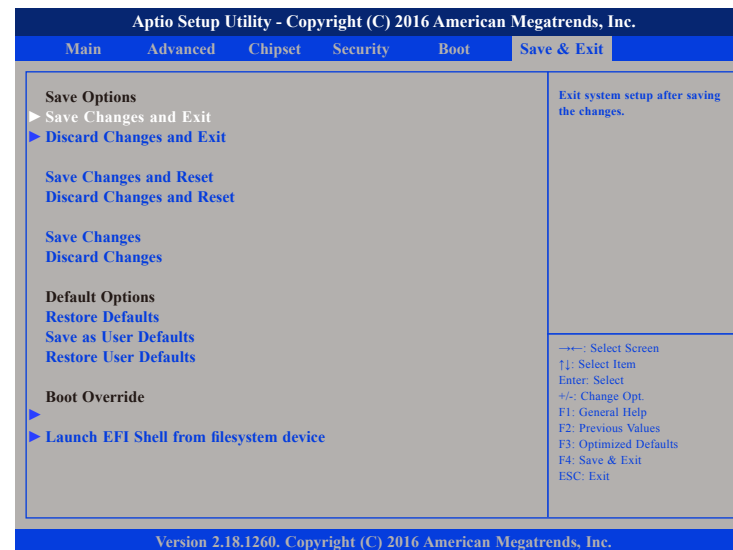

Save Changes and Exit

To save the changes and exit the Setup utility, select this field then press <Enter>. A dialog box will appear. Confirm by selecting Yes. You can also press <F4> to save and exit Setup.

Discard Changes and Exit

To exit the Setup utility without saving the changes, select this field then press <Enter>. You may be prompted to confirm again before exiting. You can also press <ESC> to exit without saving the changes.

Save Changes and Reset

To save the changes and reset, select this field then press <Enter>. A dialog box will appear. Confirm by selecting Yes.

Discard Changes and Reset

To exit the Setup utility without saving the changes, select this field then press <Enter>. You may be prompted to confirm again before exiting.

Save Changes

To save changes and continue configuring the BIOS, select this field then press <Enter>. A dialog box will appear. Confirm by selecting Yes.

Discard Changes

To discard the changes, select this field then press <Enter>. A dialog box will appear. Confirm by selecting Yes to discard all changes made and restore the previously saved settings.

Restore Defaults

To restore the BIOS to default settings, select this field then press <Enter>. A dialog box will appear. Confirm by selecting Yes.

Save as User Defaults

To use the current configurations as user default settings for the BIOS, select this field then press <Enter>. A dialog box will appear. Confirm by selecting Yes.

Restore User Defaults

To restore the BIOS to user default settings, select this field then press <Enter>. A dialog box will appear. Confirm by selecting Yes.

Boot Override

To bypass the boot sequence from the Boot Option List and boot from a particular device, select the desired device and press <Enter>.

Launch EFI Shell from filesystem device

To launch EFI shell from a filesystem device, select this field and press <Enter>.

APPENDIX A: GPIO PROGRAMMING GUIDE

GPIO (General Purpose Input/Output) pins are provided for custom system design. This appendix provides definitions and its default setting for the ten GPIO pins in EBC 357X. The pin definition is shown in the following table:

Pin	GPIO mode	PowerOn Default	Address	Pin	GPIO mode	PowerOn Default	Address
1	VCC	-	-	2	GND	-	-
3	GPO0	Low	A03h (Bit6)	4	GPIO	High	A03h (Bit1)
5	GPO1	Low	A02h (Bit5)	6	GPIO	High	A05h (Bit5)
7	GPO2	Low	A07h (Bit0)	8	GPIO	High	A05h (Bit4)
9	GPO3	Low	A07h (Bit1)	10	GPIO	High	A00h (Bit1)

Control the GPO 0/1/2/3 level from I/O port A03h bit-6/ A02h bit-5/ A07h bit-0/ A07h bit-1.

The bit is Set/Clear indicated output High/Low.

GPIO programming sample code

```
#define GPO0          (0x01 << 6)
#define GPO1          (0x01 << 5)
#define GPO2          (0x01 << 0)
#define GPO3          (0x01 << 1)

#define GPO0_HI      outputb(0xA03, GPO0)
#define GPO0_LO      outputb(0xA03, 0x00)
#define GPO1_HI      outputb(0xA02, GPO1)
#define GPO1_LO      outputb(0xA02, 0x00)
#define GPO2_HI      outputb(0xA07, GPO2)
#define GPO2_LO      outputb(0xA07, 0x00)
#define GPO3_HI      outputb(0xA07, GPO3)
#define GPO3_LO      outputb(0xA07, 0x00)
void main(void)
{
    GPO0_HI;
    GPO1_LO;
    GPO2_HI;
    GPO3_LO;
}
```

APPENDIX B: WATCHDOG TIMER SETTING

ITE8786 Watchdog Programming Guide

```

#define SUPERIO_PORT  0x2E
#define WDT_SET       0x72
#define WDT_VALUE     0x73

void main(void)
{
    #Enter SuperIO Configuration
    outputb(SUPERIO_PORT, 0x87);
    outputb(SUPERIO_PORT, 0x01);
    outputb(SUPERIO_PORT, 0x55);
    outputb(SUPERIO_PORT, 0x55);

    # Set LDN
    outputb(SUPERIO_PORT, 0x07);
    outputb(SUPERIO_PORT+1 ,0x07);

    # Set WDT setting
    outputb(SUPERIO_PORT, WDT_SET);
    outputb(SUPERIO_PORT+1, 0x90);           # Use the second
                                           # Use the minute, change value to 0x10

    # Set WDT sec/min
    outputb(SUPERIO_PORT, WDT_VALUE);
    outputb(SUPERIO_PORT+1, 0x05);         #Set 5 seconds
}

```