

MI996

**9th Gen. Intel[®] Core™ i9/i7/i5/i3
/ Xeon[®] E / Celeron[®]
Mini-ITX Motherboard**

User's Manual

Version 1.0
(May 2020)

Copyright

© 2020 IBASE Technology, Inc. All rights reserved.

No part of this publication may be reproduced, copied, stored in a retrieval system, translated into any language or transmitted in any form or by any means, electronic, mechanical, photocopying, or otherwise, without the prior written consent of IBASE Technology, Inc. (hereinafter referred to as “IBASE”).

Disclaimer

IBASE reserves the right to make changes and improvements to the products described in this document without prior notice. Every effort has been made to ensure the information in the document is correct; however, IBASE does not guarantee this document is error-free.

IBASE assumes no liability for incidental or consequential damages arising from misapplication or inability to use the product or the information contained herein, nor for any infringements of rights of third parties, which may result from its use.

Trademarks

All the trademarks, registrations and brands mentioned herein are used for identification purposes only and may be trademarks and/or registered trademarks of their respective owners.

Compliance



This is a class B product. In a domestic environment, this product may cause radio interference in which case users may be required to take adequate measures.



This product has been tested and found to comply with the limits for a Class B device, pursuant to Part 15 of the FCC Rules. These limits are designed to provide reasonable protection against harmful interference in a residential installation. This equipment generates, uses and can radiate radio frequency energy and, if not installed and used in accordance with manufacturer's instructions, may cause harmful interference to radio communications.

WEEE



This product must not be disposed of as normal household waste, in accordance with the EU directive of for waste electrical and electronic equipment (WEEE - 2012/19/EU). Instead, it should be disposed of by returning it to a municipal recycling collection point. Check local regulations for disposal of electronic products.

Green IBASE



This product is compliant with the current RoHS restrictions and prohibits use of the following substances in concentrations exceeding 0.1% by weight (1000 ppm) except for cadmium, limited to 0.01% by weight (100 ppm).

- Lead (Pb)
- Mercury (Hg)
- Cadmium (Cd)
- Hexavalent chromium (Cr6+)
- Polybrominated biphenyls (PBB)
- Polybrominated diphenyl ether (PBDE)

Important Safety Information

Carefully read the precautions before using the board.

Environmental conditions:

- Use this product in environments with ambient temperatures between 0°C and 60°C.
- Do not leave this product in an environment where the storage temperature may be below -20° C or above 70° C. To prevent from damages, the product must be used in a controlled environment.

Care for your iBASE products:

- Before cleaning the PCB, unplug all cables and remove the battery.
- Clean the PCB with a circuit board cleaner, degreaser, or use cotton swabs and alcohol.
- Vacuum the dust with a computer vacuum cleaner to prevent the fan from being clogged.



WARNING

Anti-static precautions

- Wear an anti-static wrist strap to avoid electrostatic discharge.
- Place the PCB on an anti-static kit or mat.
- Hold the edges of PCB when handling.
- Touch the edges of non-metallic components of the product instead of the surface of the PCB.
- Ground yourself by touching a grounded conductor or a grounded bit of metal frequently to discharge any static.



CAUTION

Replace only with the same or equivalent type recommended by the manufacturer. Dispose of used batteries according to the manufacturer's instructions or recycle them at a local recycling facility or battery collection point.

Warranty Policy

- **IBASE standard products:**

24-month (2-year) warranty from the date of shipment. If the date of shipment cannot be ascertained, the product serial numbers can be used to determine the approximate shipping date.

- **3rd-party parts:**

12-month (1-year) warranty from delivery for the 3rd-party parts that are not manufactured by IBASE, such as CPU, CPU cooler, memory, storage devices, power adapter, panel and touchscreen.

- * PRODUCTS, HOWEVER, THAT FAIL DUE TO MISUSE, ACCIDENT, IMPROPER INSTALLATION OR UNAUTHORIZED REPAIR SHALL BE TREATED AS OUT OF WARRANTY AND CUSTOMERS SHALL BE BILLED FOR REPAIR AND SHIPPING CHARGES.

Technical Support & Services

1. Visit the IBASE website at www.ibase.com.tw to find the latest information about the product.
2. If you need any further assistance from your distributor or sales representative concerning problems that you may have encountered, please prepare the following information:
 - Product model name
 - Product serial number
 - Detailed description of the problem
 - The error messages in text or in screenshots if there is any
 - The arrangement of the peripherals
 - Software in use (such as OS and application software, including the version numbers)
3. If repair service is required, you can download the RMA form at <http://www.ibase.com.tw/english/Supports/RMAService/>. Fill out the form and contact your distributor or sales representative.

Table of Contents

Chapter 1	General Information	1
1.1	Introduction	2
1.2	Features	2
1.3	Packing List.....	3
1.4	Optional Accessories.....	3
1.5	Specifications	4
1.6	Block Diagram	6
1.7	Product View	7
1.8	Dimensions	9
Chapter 2	Hardware Configuration	11
2.1	Installations	12
2.1.1	Installing the Memory	12
2.2	Setting the Jumpers.....	13
2.3	Jumper & Connector Locations on MI996.....	14
2.4	Jumpers Quick Reference	15
2.4.1	eDP Panel Power Selection (JP3).....	15
2.4.2	Clearing CMOS Data (JP6)	16
2.4.3	Clearing ME Register (JP7).....	16
2.4.4	PCIe (x16) Bifurcation Selection (JP8 & JP9)	17
2.5	Connectors Quick Reference.....	18
2.5.1	COM1 & COM2 RS-232/422/485 Ports (CN1).....	19
2.5.2	COM3 & COM4 RS-232 Ports (J2, J3)	20
2.5.3	eDP Connector (CN11)	21
2.5.4	Digital I/O Connector (J1).....	22
2.5.5	ATX Power Connector (J4).....	23
2.5.6	ATX 12V Power Connector (J6).....	24
2.5.7	Dual USB 2.0 Connector (J13, J15).....	24
2.5.8	Front Panel Audio Connector (J16)	25
2.5.9	Front Panel Settings Connector (J18).....	26
2.5.10	RTC Battery Connector (J17)	27
2.5.11	CPU Fan Power Connector (CPU_FAN1)	27
2.5.12	System Fan Power Connector (SYS_FAN1, SYS_FAN2)....	28

Chapter 3	Drivers Installation	29
3.1	Introduction	30
3.2	Intel® Chipset Software Installation Utility	30
3.3	HD Graphics Driver Installation	33
3.4	HD Audio Driver Installation	36
3.5	LAN Driver Installation	37
3.6	Intel® Management Engine Drivers Installation	40
Chapter 4	BIOS Setup	41
4.1	Introduction	42
4.2	BIOS Setup	42
4.3	Main Settings	43
4.4	Advanced Settings	43
4.5	Chipset Settings	56
4.6	Security Settings	61
4.7	Boot Settings	64
4.8	Save & Exit Settings	65
Appendix		67
A.	I/O Port Address Map	68
B.	Interrupt Request Lines (IRQ)	70
C.	Watchdog Timer Configuration	71
D.	Onboard Connector Types	75

Chapter 1

General Information

The information provided in this chapter includes:

- Features
- Packing List
- Specifications
- Block Diagram
- Product View
- Board Dimensions

1.1 Introduction

MI996 is a mini-ITX motherboard designed for the Intel® 9th Gen processor and is suitable for embedded applications in a broad range of markets, including industrial control & automation, digital signage, thin client, and SMB storage appliances. MI996 provides high computing and graphics processing capabilities and can also be utilized for designs with low power consumption.

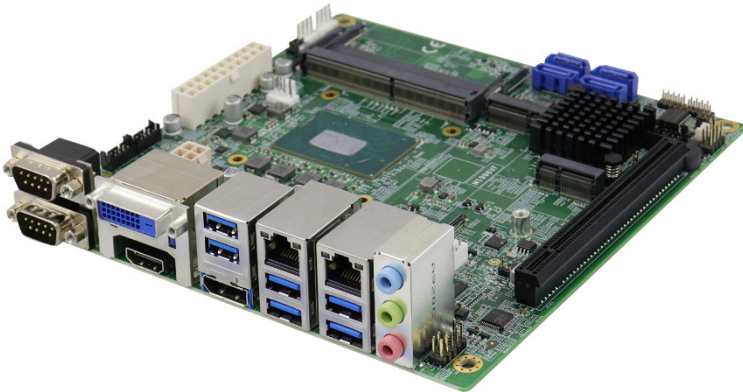

MI996

1.2 Features

- Supports 9th Gen. Intel® Xeon® E / Core™/Celeron® i9/i7/i5/i3 processor, up to 4.5 GHz
- 2 x DDR4 SO-DIMM, expandable up to 32 GB, ECC supported per CPU SKUs
- Intel® processor integrated graphics device for DVI-D, HDMI (2.0a) and DisplayPort
- 2 x GbE LAN, 6 x USB 3.1, 4 x USB 2.0, 4 x COM, 4 x SATA III
- 1 x PCIe (x16), 1 x Mini-PCIe, 2 x M.2 (M2280 & E2230)
- Configurable watchdog timer and digital I/O
- iAMT (11.6), TPM (2.0) and iSMART
- vPro (for MI996VF series only)

1.3 Packing List

Your MI996 package should include the items listed below. If any of the items below is missing, contact the distributor or dealer from whom you purchased the product.

- MI996 Motherboard x1
- I/O Shield x1
- SATA Cable (SATA-3F) x1
- COM Port Cable (PK1H) x1
- Disk (including chipset drivers) x1
- This User's Manual x1

1.4 Optional Accessories

IBASE provides the following optional accessories:

- Audio Cable (Audio-34)
- USB Cable (USB-29)
- Mini-PCIe extension bracket

1.5 Specifications

Product Name	MI996VF Series
Form Factor	Mini-ITX motherboard
System	
Operating System	<ul style="list-style-type: none"> • Windows 10 (64-bit) • Linux Fedora (64-bit) & Ubuntu (64-bit) • Windows Server
CPU & Chipset	<ul style="list-style-type: none"> • MI996VF-X28: Intel® Xeon® E-2276ME (2.8 ~ 4.5 GHz) with Intel® CM246 • MI996VF-9880: Intel® 9th Gen. Core™ i9-9880H (2.3 ~ 4.8 GHz) with Intel® QM370 • MI996VF-9850: Intel® 9th Gen. Core™ i7-9850HE (2.7 ~ 4.4 GHz) with Intel® QM370 • MI996VF-9400: Intel® 9th Gen. Core™ i5-9400H (2.75 ~ 4.3 GHz) with Intel® QM370 • MI996EF-9100: Intel® 9th Gen. Core™ i3-9100HL (1.6 ~ 2.9 GHz) with Intel® HM370 • MI996EF-4930: Intel® 9th Gen. Celeron® G4930E (2.4 GHz) with Intel® HM370
Memory	2 x DDR4 SO-DIMM 2666 MHz, expandable up to 32 GB * ECC will be supported by identified CPU SKUs. * 2666MHz will be supported by identified CPU SKUs.
Storage	mSATA / M.2 (M2280)
Graphics	HD graphics integrated into the processor
Network	<p>MI996VF-X28: 1st LAN: Intel® I219LM GbE 2nd LAN: Intel® I210AT GbE</p> <p>MI996VF-9880/9850 / 9400: 1st LAN: Intel® I219LM GbE 2nd LAN: Intel® I211AT GbE</p> <p>MI996EF-9100/4930: 1st LAN: Intel® I219V GbE 2nd LAN: Intel® I211AT GbE</p>
Super I/O	Fintek F81964D-I
Audio Codec	Realtek ALC888S
Power Supply	ATX Power, 12V
Watchdog Timer	Yes (256 segments, 0, 1, 2...255 sec / min)
BIOS	AMI BIOS
iSMART	Yes
RAID	RAID 0/1/5/10
iAMT	11.6
TPM	2.0

vPro	* For MI996VF series only
EuP / ErP	* For MI996EF series only
Dimensions	170 x 170 mm (6.7" x 6.7")
RoHS	Yes
Certification	CE (EN55032:2012), FCC Class B
I/O Ports	
Display	<ul style="list-style-type: none"> • 1 x HDMI 2.0a (4096 x 2304 at 60 Hz) • 1 x DisplayPort (4096 x 2304 at 60 Hz) • 1 x DVI-D (1920 x 1080p at 60 Hz) • 1 x eDP (1920 x 1080p at 60 Hz)
LAN	2 x RJ45 GbE LAN
USB	<ul style="list-style-type: none"> • 6 x USB 3.1 (I/O coastline connectors) • 4 x USB 2.0 (via onboard pin headers)
Serial	4 x COM ports: <ul style="list-style-type: none"> • COM1 & COM2: RS-232/422/485 (I/O coastline connectors, jumper-less selection) • COM3 ~ COM4: RS-232 only (via on-board box-headers)
SATA	MI996VF-X28: 4 x SATA 3.0 MI996VF-9880/9850/9400, MI996EF-9100/4930: 2 x SATA 3.0
Audio Jack	1 x Line-In, 1 x Line-Out, 1 x Mic-In
Digital IO	4-In & 4-Out
SSD	1 x M.2 (M2280) slot
Expansion Slots	<ul style="list-style-type: none"> • 1 x PCIe (x16) slot • 1 x full/half-size Mini-PCIe slot with PCIe or SATA • 1 x M.2 (E2230) slot
Environment	
Temperature	<ul style="list-style-type: none"> • Operation: 0 ~ 60 °C (32 ~ 140 °F) • Storage: -20 ~ 70 °C (-4 ~ 158 °F)
Relative Humidity	10 ~ 90 %, non-condensing at 60 °C

All specifications are subject to change without prior notice.

1.6 Block Diagram

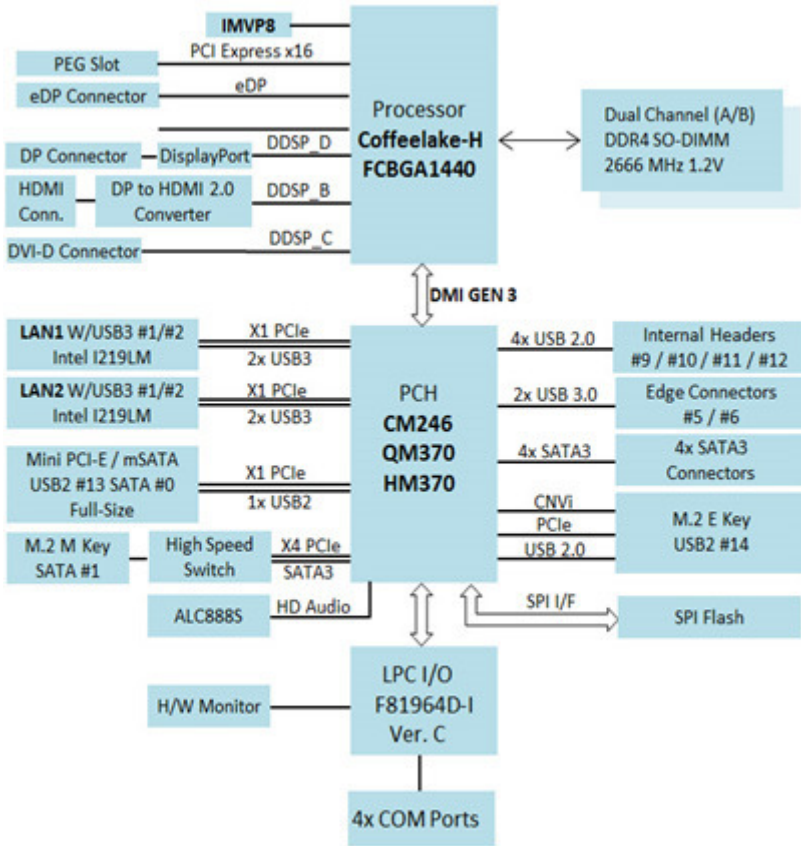

1.7 Product View

Top View

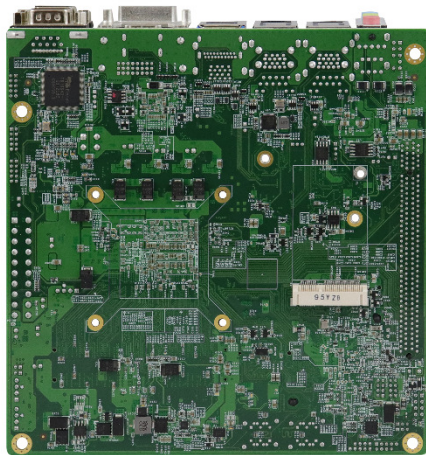
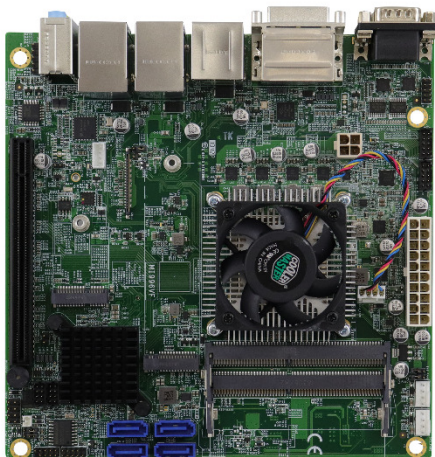

* The photos above are for reference only. Some minor components may differ.

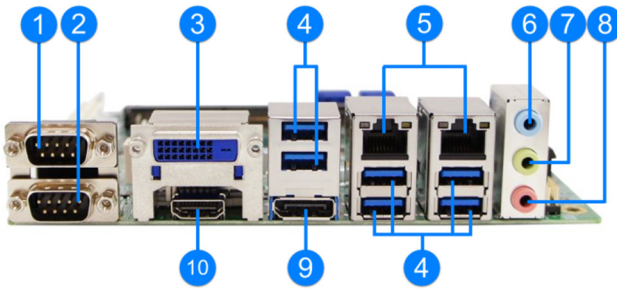
I/O View

No.	Name	No.	Name
1	COM1 Port	6	Audio Line-In
2	COM2 Port	7	Audio Line-Out
3	DVI-D Port	8	Microphone-In
4	6 USB 3.1 Ports	9	DisplayPort
5	LAN Ports	10	HDMI Port

1.8 Dimensions

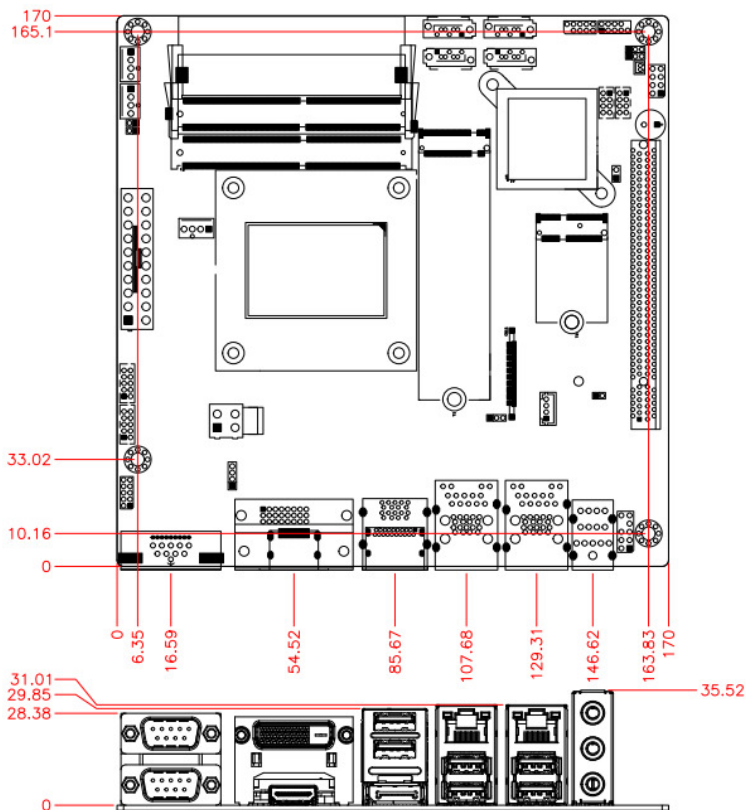

This page is intentionally left blank.

Chapter 2

Hardware Configuration

This section provides information on jumper settings and connectors on the MI996 in order to set up a workable system. On top of that, you will also need to install crucial pieces such as the CPU and the memory before using the product. The topics covered are:

- Installations: CPU and the memory
- Jumper and connector locations
- Jumper settings and information of connectors

2.1 Installations

2.1.1 Installing the Memory

To install the modules, locate the memory slot on the board and perform the following steps:

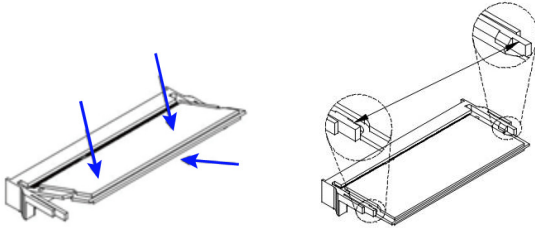

1. Align the key of the memory module with that on the memory slot and insert the module slantwise.
2. Gently push the module in an upright position until the clips of the slot close to hold the module in place when the module touches the bottom of the slot.

To remove the module, press the clips outwards with both hands, and the module will pop-up.

2.2 Setting the Jumpers

Set up and configure your MI996 by using jumpers for various settings and features according to your needs and applications. Contact your supplier if you have doubts about the best configuration for your use.

2.2.1 How to Set Jumpers

Jumpers are short-length conductors consisting of several metal pins with a non-conductive base mounted on the circuit board. Jumper caps are used to have the functions and features enabled or disabled. If a jumper has 3 pins, you can connect either PIN1 to PIN2 or PIN2 to PIN3 by shorting.

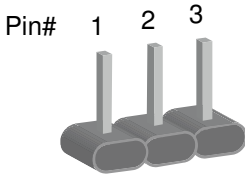

A 3-pin jumper

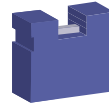

A jumper cap

Refer to the illustration below to set jumpers.

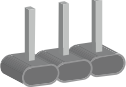
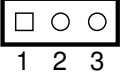
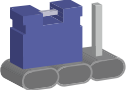
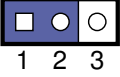
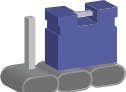
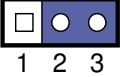
Pin closed	Oblique view	Illustration
Open		 1 2 3
1-2		 1 2 3
2-3		 1 2 3

When two pins of a jumper are encased in a jumper cap, this jumper is **closed**, i.e. turned **On**.

When a jumper cap is removed from two jumper pins, this jumper is **open**, i.e. turned **Off**.

2.3 Jumper & Connector Locations on MI996

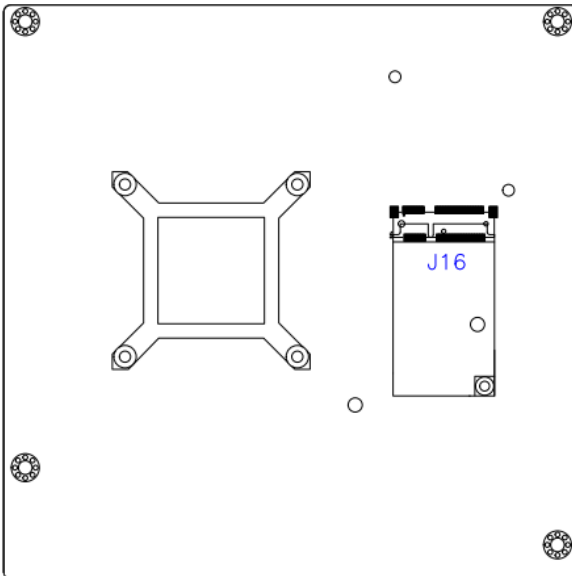
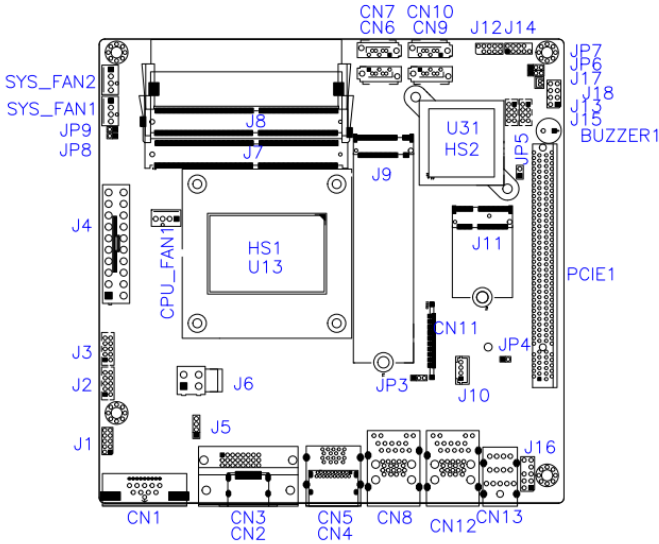



2.4 Jumpers Quick Reference

Function	Jumper	Page
eDP Panel Power Selection	JP3	15
Clearing CMOS Data	JP6	16
Clearing ME Register	JP7	16
PCIe Bifurcation Selection	JP8, JP9	17
Factory Use Only	JP4, JP5	--

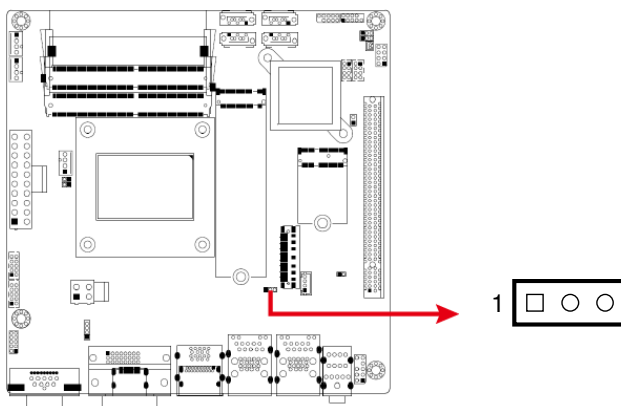
2.4.1 eDP Panel Power Selection (JP3)



Function	Pin closed	Illustration
3.3V (default)	1-2	1 
5V	2-3	1 

2.4.2 Clearing CMOS Data (JP6)

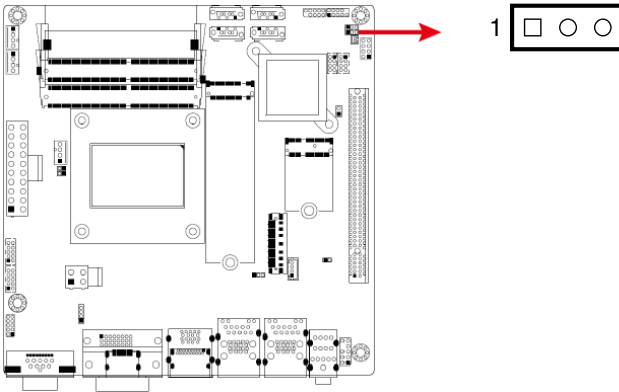

Function	Pin closed	Illustration
Normal (default)	1-2	1
Clear CMOS	2-3	1



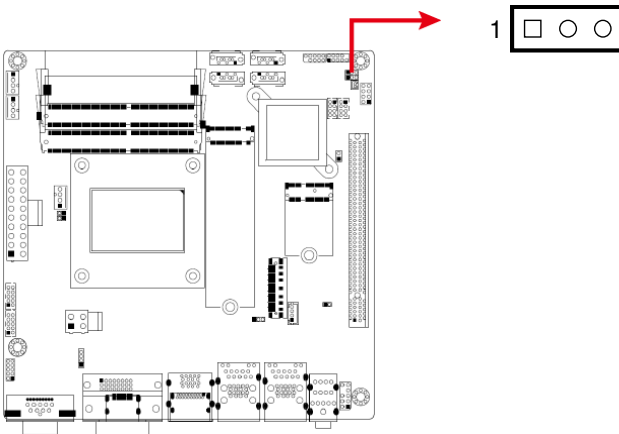



2.4.3 Clearing ME Register (JP7)

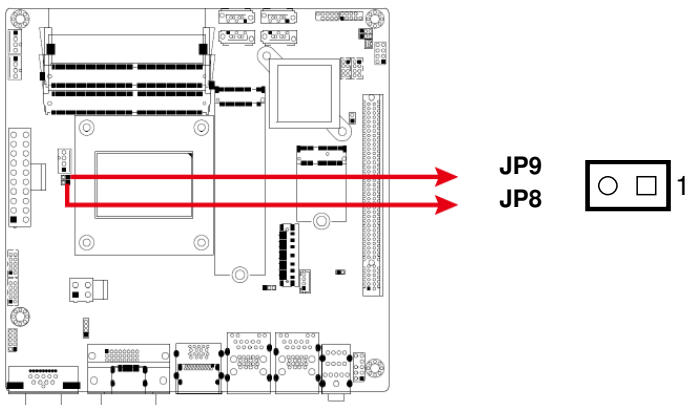

Function	Pin closed	Illustration
Normal (default)	1-2	1
Clear ME	2-3	1

2.4.4 PCIe (x16) Bifurcation Selection (JP8 & JP9)



Function	Pin closed	Illustration
1 x PCIe (x16) (default)	JP8: Open	 1
	JP9: Open	 1
2 x PCIe (x8)	JP8: Close	 1
	JP9: Open	 1
1 x PCIe (x8) 2 x PCIe (x4)	JP8: Close	 1
	JP9: Close	 1

2.5 Connectors Quick Reference

Function	Connector Name	Page
COM1 & COM2 Ports	CN1	19
COM3 & COM4 RS-232 Ports	J2 (COM3), J3 (COM4)	20
eDP Connector	CN11	21
Digital I/O Connector	J1	22
ATX Power Connector	J4	23
ATX 12V Power Connector	J6	24
Dual USB 2.0 Connector	J13, J15	25
Front Panel Audio Connector	J16	25
Front Panel Settings Connector	J18	26
RTC Battery Connector	J17	27
CPU Fan Power Connector	CPU_FAN1	27
System Fan Power Connector	SYS_FAN1, SYS_FAN2	28
DVI-D Port	CN2	--
HDMI Port	CN3	--
Dual USB 3.1 Ports	CN4	--
DisplayPort	CN5	--
SATA III Port	CN6, CN7, CN9, CN10	--
GbE LAN Port & Dual USB 3.1 Ports	CN8, CN12	--
DDR4 SO-DIMM Slot	J7, J8	--
M.2 M2280 Slot	J9	--
M.2 E2230 Slot	J11	--
RTC Battery Cell	J17	--
Mini-PCIe Slot	J19	--
PCIe (x16) Slot	PCIE1	
Factory Use Only	J5, J10, J12, J14	--

2.5.1 COM1 & COM2 RS-232/422/485 Ports (CN1)

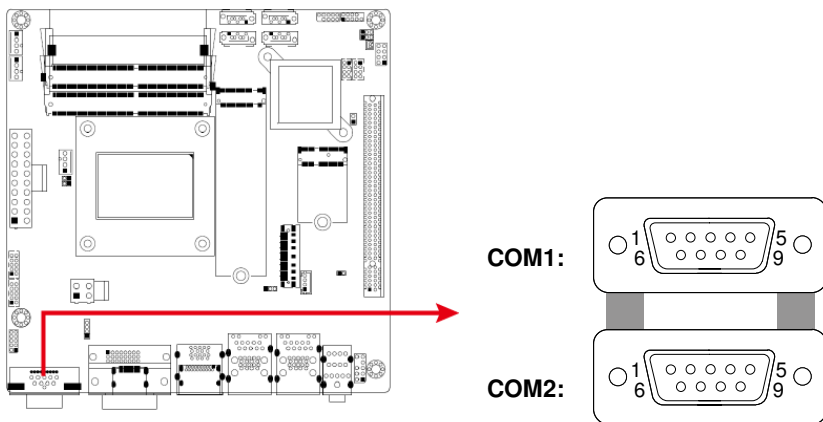

Pin	Signal Name	Pin	Signal Name
1	DCD, Data carrier detect	6	DSR, Data set ready
2	RXD, Receive data	7	RTS, Request to send
3	TXD, Transmit data	8	CTS, Clear to send
4	DTR, Data terminal ready	9	RI, Ring indicator
5	Ground		

Pin	Signal Name		
	RS-232	RS-422	RS-485
1	DCD	TX-	DATA-
2	RX	TX+	DATA+
3	TX	RX+	NC
4	DTR	RX-	NC
5	Ground	Ground	Ground
6	DSR	NC	NC
7	RTS	NC	NC
8	CTS	NC	NC
9	RI	NC	NC

2.5.2 COM3 & COM4 RS-232 Ports (J2, J3)

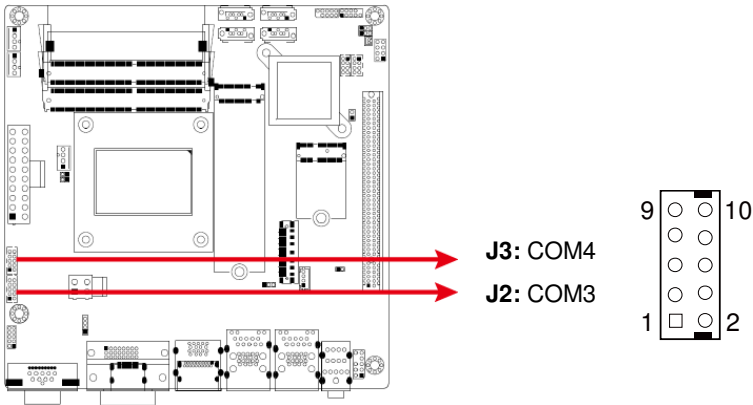

Pin	Signal Name	Pin	Signal Name
1	DCD, Data carrier detect	2	RXD, Receive data
3	TXD, Transmit data	4	DTR, Data terminal ready
5	Ground	6	DSR, Data set ready
7	RTS, Request to send	8	CTS, Clear to send
9	RI, Ring indicator	10	Key

2.5.3 eDP Connector (CN11)

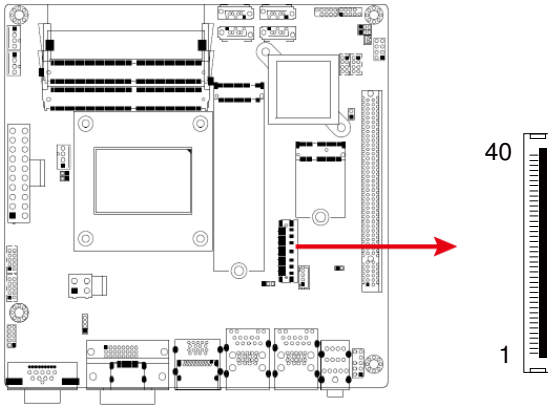

Pin	Signal Name	Pin	Signal Name
1	eDP VCC	21	TXN0
2	eDP VCC	22	TXP0
3	eDP VCC	23	Ground
4	eDP VCC	24	AUXP
5	eDP VCC	25	AUXN
6	Ground	26	X
7	Ground	27	+3.3V
8	Ground	28	+12V
9	Ground	29	X
10	Hot Plug detect	30	Ground
11	Ground	31	+5V
12	TXN3	32	X
13	TXP3	33	Back Light Control
14	Ground	34	Back Light Enable
15	TXN2	35	+12V
16	TXP2	36	+3.3V
17	Ground	37	Ground
18	TXN1	38	X
19	TXP1	39	X
20	Ground	40	X

2.5.4 Digital I/O Connector (J1)

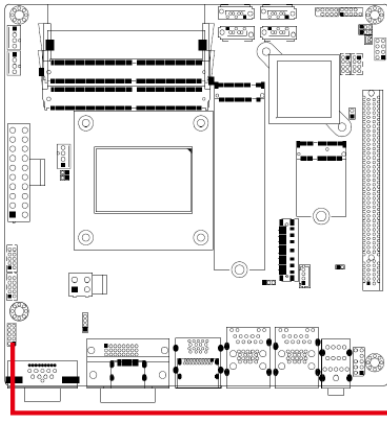

(4-In, 4-Out)

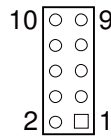

Pin	Signal Name	Pin	Signal Name
1	Ground	2	+5V
3	OUT3	4	OUT1
5	OUT2	6	OUT0
7	IN3	8	IN1
9	IN2	10	IN0

2.5.5 ATX Power Connector (J4)

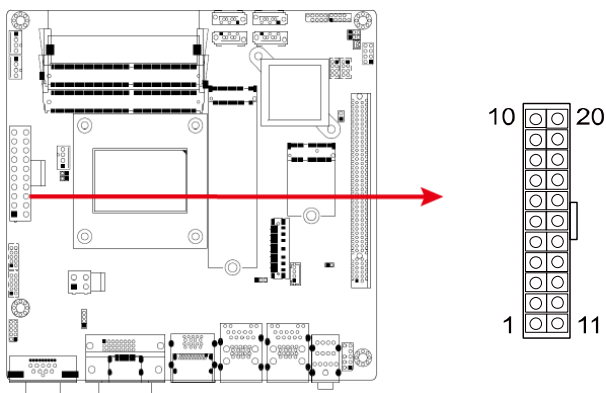

Pin	Signal Name	Pin	Signal Name
1	3.3V	11	3.3V
2	3.3V	12	-12V
3	Ground	13	Ground
4	+5V	14	PS-ON
5	Ground	15	Ground
6	+5V	16	Ground
7	Ground	17	Ground
8	Power good	18	-5V
9	5VSB	19	+5V
10	+12V	20	+5V

2.5.6 ATX 12V Power Connector (J6)

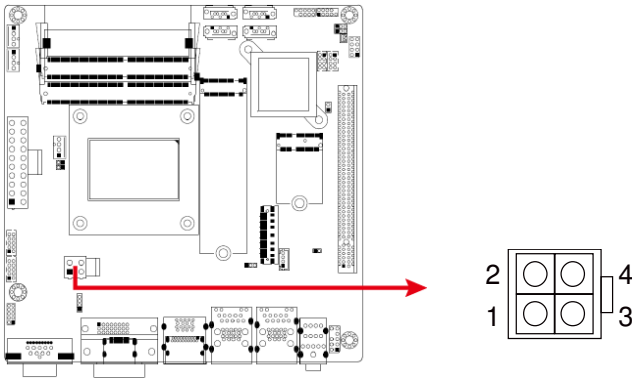

Pin	Signal Name	Pin	Signal Name
1	Ground	3	+12V
2	Ground	4	+12V

2.5.7 Dual USB 2.0 Connector (J13, J15)

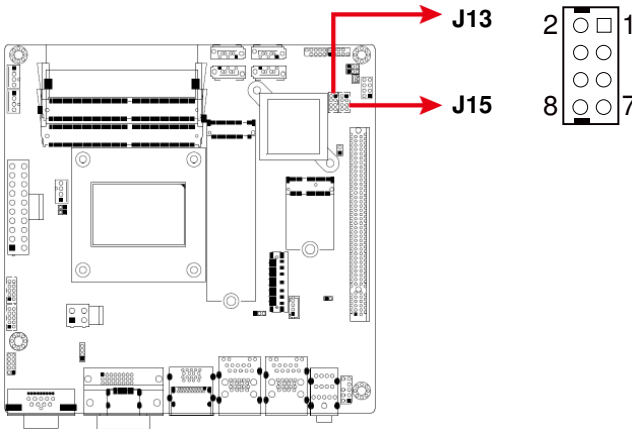

Pin	Signal Name	Pin	Signal Name
1	VCC	2	Ground
3	D0-	4	D1+
5	D0+	6	D1-
7	Ground	8	VCC

2.5.8 Front Panel Audio Connector (J16)

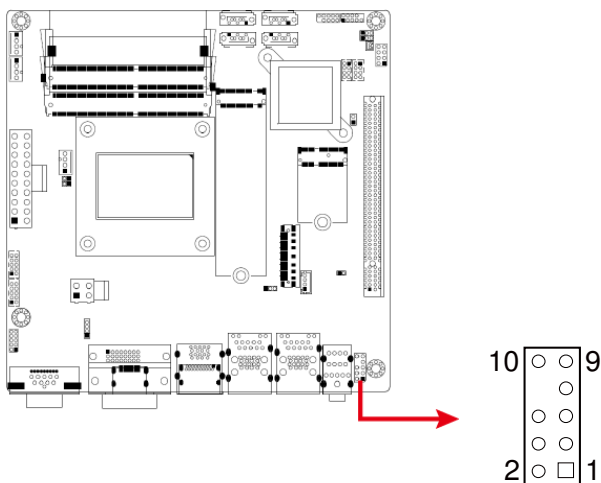

Pin	Signal Name	Pin	Signal Name
1	MIC IN_L	2	Ground
3	MIC IN_R	4	DET
5	LINE_R	6	Ground
7	Sense	8	Key
9	LINE_L	10	Ground

2.5.9 Front Panel Settings Connector (J18)

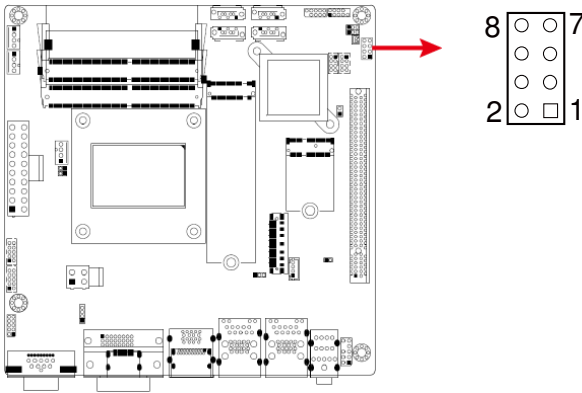

Pin	Signal Name	Pin	Signal Name
1	Power BTN	2	Power BTN
3	HDD LED+	4	HDD LED-
5	Reset BTN	6	Reset BTN
7	Power LED+	8	Power LED-

J18 is utilized for system indicators to provide light indication of the computer activities and switches to change the computer status. It provides interfaces for the following functions.

- ATX Power ON Switch (Pins 1 and 2)**

The 2 pins make an “ATX Power Supply On/Off Switch” for the system that connects to the power switch on the case. When pressed, the power switch will force the system to power on. When pressed again, it will power off the system.
- Hard Disk Drive LED Connector (Pins 3 and 4)**

This connector connects to the hard drive activity LED on control panel. This LED will flash when the HDD is being accessed.
- Reset Switch (Pins 5 and 6)**

The reset switch allows you to reset the system without turning the main power switch off and then on again. Orientation is not required when making a connection to this header.
- Power LED (Pins 7 and 8)**

This connector connects to the system power LED on control panel. This LED will light when the system turns on.

2.5.10 RTC Battery Connector (J17)

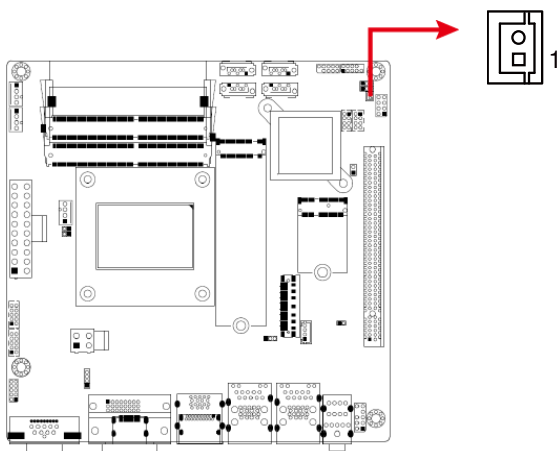

Pin	Signal Name	Pin	Signal Name
1	Battery+	2	Ground

2.5.11 CPU Fan Power Connector (CPU_FAN1)

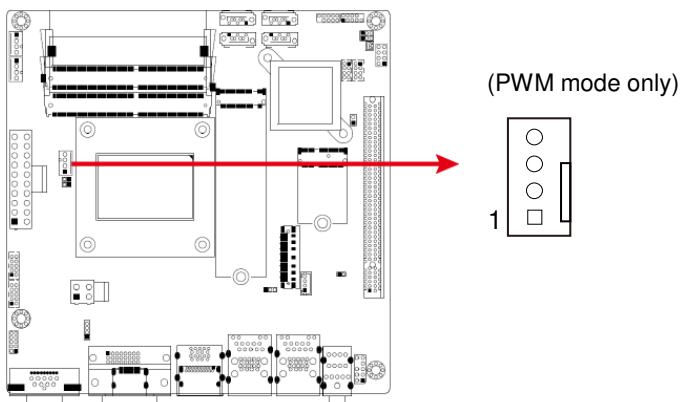

Pin	Signal Name	Pin	Signal Name
1	Ground	3	Rotation detection
2	+12V	4	Control

2.5.12 System Fan Power Connector (SYS_FAN1, SYS_FAN2)

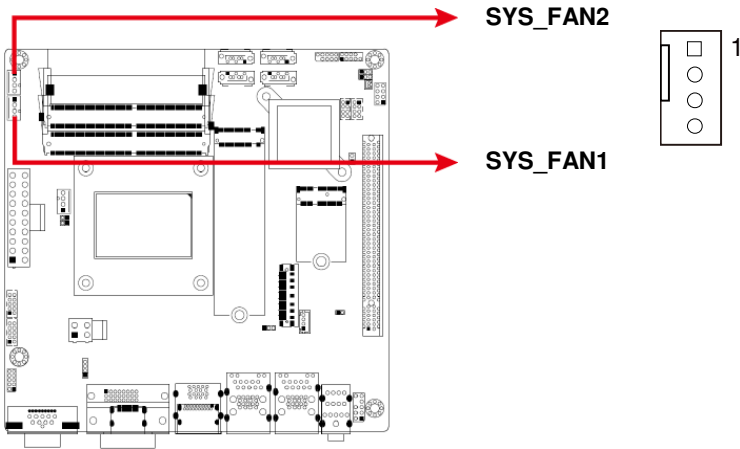

Pin	Signal Name	Pin	Signal Name
1	Ground	3	Rotation detection
2	+12V	4	Control

Chapter 3

Drivers Installation

This chapter introduces installation of the following drivers:

- Intel® Chipset Software Installation Utility
- HD Graphics Driver
- HD Audio Driver
- LAN Driver
- Intel® Management Engine Drivers Installation

3.1 Introduction

This section describes the installation procedures for software and drivers. The software and drivers are included with the motherboard. If you find anything missing, please contact the distributor where you made the purchase. The contents of this section include the following:

Note: After installing your operating system, you must install the Intel® Chipset Software Installation Utility first before proceeding with the drivers installation.

3.2 Intel® Chipset Software Installation Utility

The Intel® Chipset drivers should be installed first before the software drivers to install INF files for Plug & Play function for Intel chipset components.

1. Insert the disk enclosed in the package with the board. Click **Intel** on the left pane and then **Intel(R) Coffeelake Chipset Drivers** on the right pane.

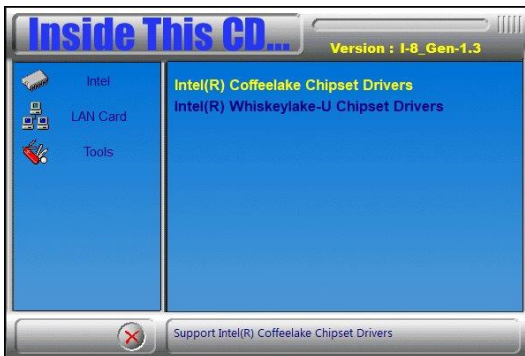

2. Click **Intel(R) Chipset Software Installation Utility**.



3. When the welcome screen appears, click **Next**.



4. Accept the license agreement to continue.



5. In the Readme File Information window, click **Install**.

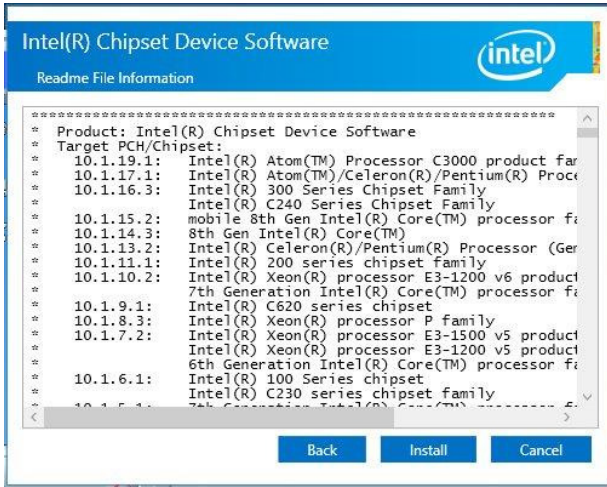

6. After the installation of the chipset device software, restart the computer for changes to take effect.



3.3 HD Graphics Driver Installation

1. Click **Intel** on the left pane and then **Intel(R) Coffeelake Chipset Drivers** on the right pane.



2. Click **Intel(R) HD Graphics Driver**.

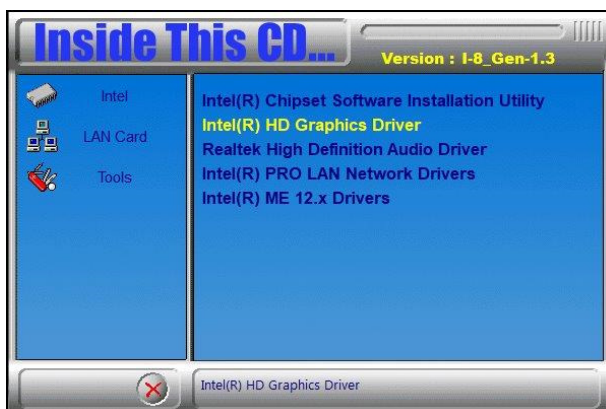

3. In the welcome to the setup program screen, click **Next**.

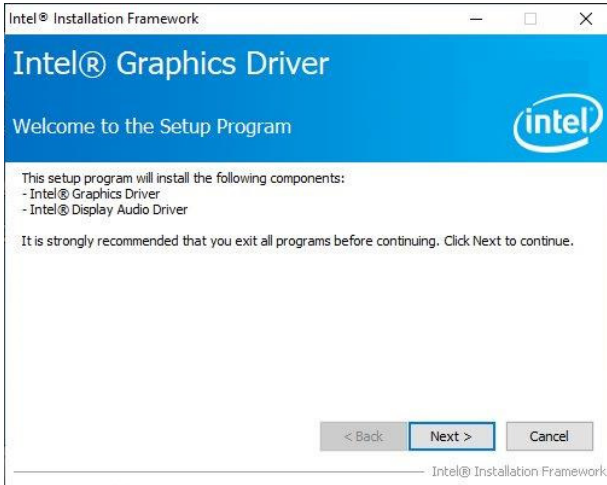

4. Click **Yes** to accept the license agreement.

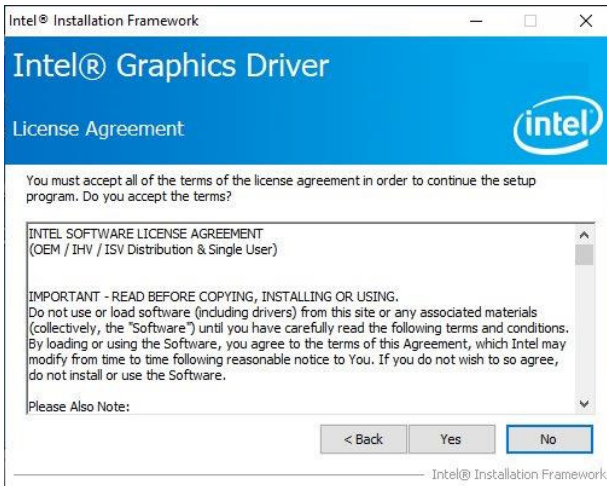

5. In the Readme File Information screen, click **Next**.

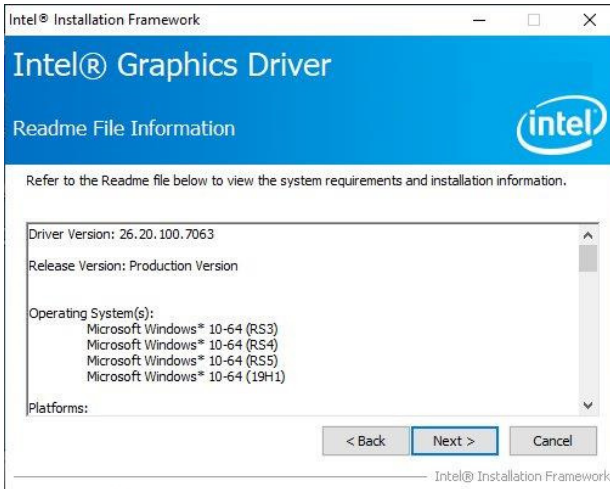

6. When prompted, click **Next** in the Setup Progress screen.

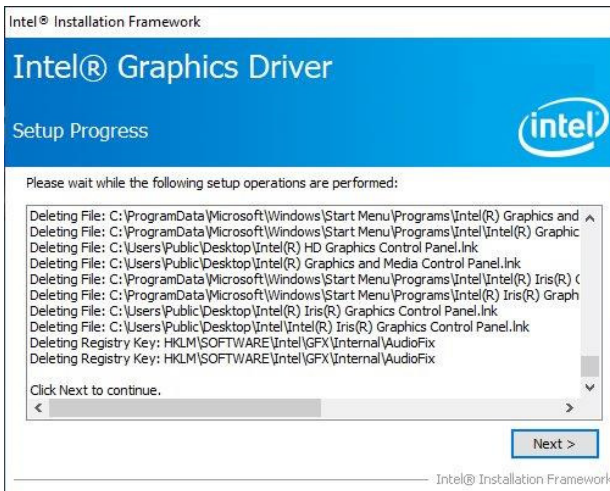

7. When Setup is Complete, restart the system for changes to take effect.

3.4 HD Audio Driver Installation

1. Click **Intel** on the left pane and then **Intel(R) Coffeelake Chipset Drivers** on the right pane.
2. Click **Realtek High Definition Audio Driver**.



3. When the *Welcome* screen of the InstallShield Wizard appears, click **Next**.
4. When prompted on the next screen, click **Next** to start the installation.
5. When the driver has been completely installed, restart the system for changes to take effect.

3.5 LAN Driver Installation

1. Click **Intel** on the left pane and then **Intel(R) Coffeelake Chipset Drivers** on the right pane. Click **Intel(R) PRO LAN Network Drivers**.



2. When the *Welcome* screen appears, click **Next**.

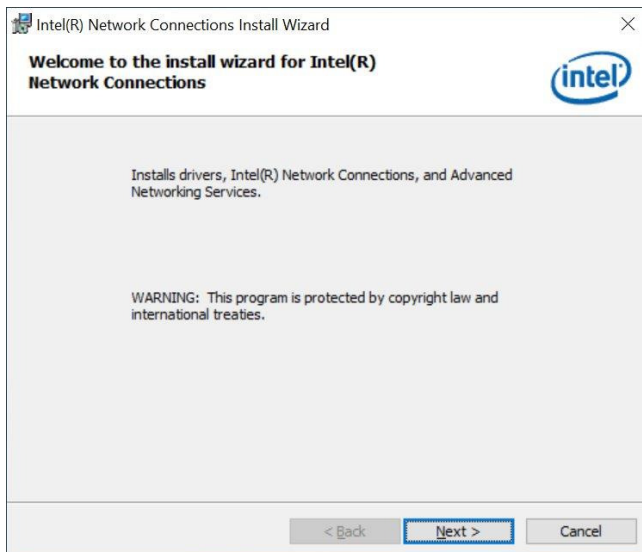

3. Accept the license agreement and click **Next**.

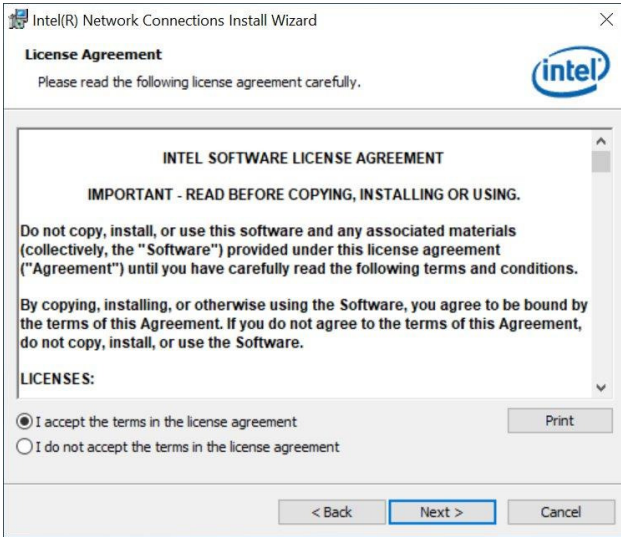

4. On the *Setup Options* screen, click the checkbox to select the desired driver(s) for installation. Then click **Next** to continue.

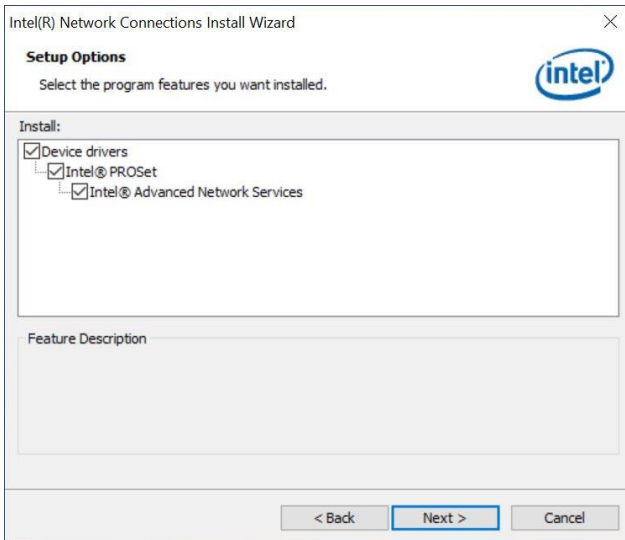

5. Click **Install** to begin the installation.

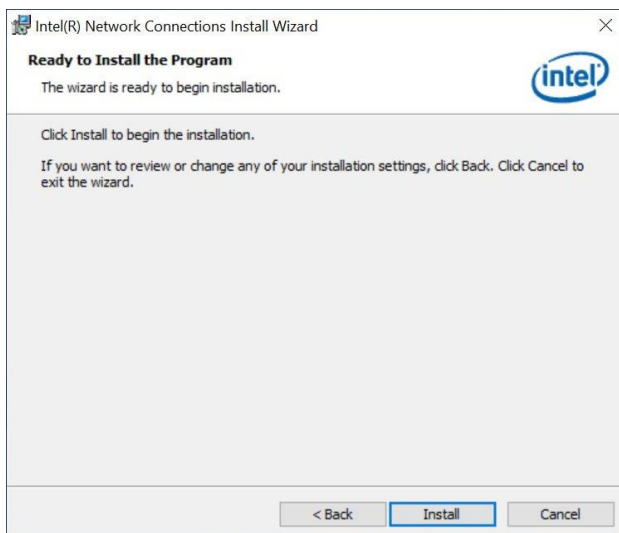

6. When installation has been completed, click **Finish**.

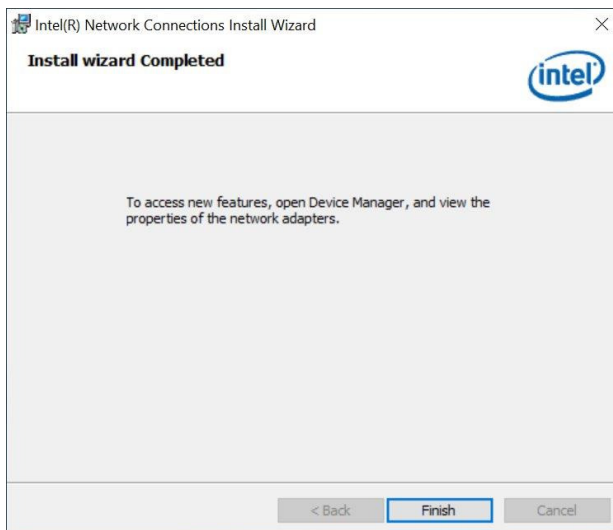

3.6 Intel® Management Engine Drivers Installation

1. Click **Intel** on the left pane and then **Intel(R) Coffeelake Chipset Drivers** on the right pane. Click **Intel(R) ME 12.x Drivers**.



2. When the *Welcome* screen appears, click **Next**.

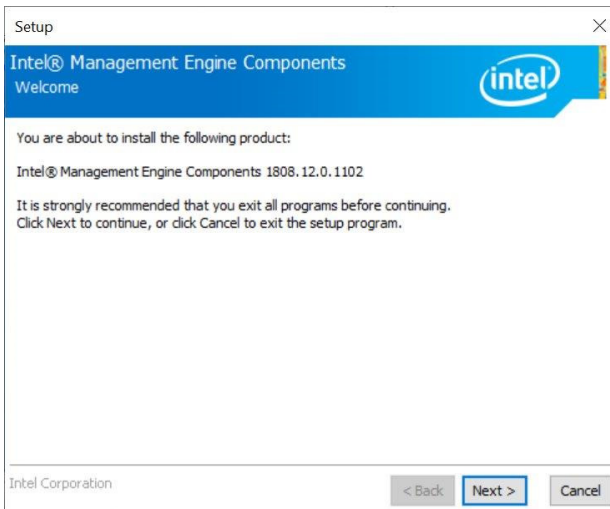

3. Accept the license agreement, choose the destination folder and click **Next** until the installation starts.
4. After the Intel Management Engine Components have been successfully installed, restart the system for changes to take effect.

Chapter 4

BIOS Setup

This chapter describes the different settings available in the AMI BIOS that comes with the board. The topics covered in this chapter are as follows:

- Main Settings
- Advanced Settings
- Chipset Settings
- Boot Settings
- Security Settings
- Save & Exit

4.1 Introduction

The BIOS (Basic Input/Output System) installed in the ROM of your computer system supports Intel® processors. The BIOS provides critical low-level support for standard devices such as disk drives, serial ports and parallel ports. It also provides password protection as well as special support for detailed fine-tuning of the chipset controlling the entire system.

4.2 BIOS Setup

The BIOS provides a Setup utility program for specifying the system configurations and settings. The BIOS ROM of the system stores the Setup utility. When you turn on the computer, the BIOS is immediately activated. Press the key immediately allows you to enter the Setup utility. If you are a little bit late pressing the key, POST (Power On Self Test) will continue with its test routines, thus preventing you from invoking the Setup.

If you still need to enter Setup, restart the system by pressing the "Reset" button or simultaneously pressing the <Ctrl>, <Alt> and <Delete> keys. You can also restart by turning the system Off and back On again.

The following message will appear on the screen:

```
Press <DEL> to Enter Setup
```

In general, press the arrow keys to highlight items, <Enter> to select, the <PgUp> and <PgDn> keys to change entries, <F1> for help, and <Esc> to quit.

When you enter the BIOS Setup utility, the *Main Menu* screen will appear on the screen. The Main Menu allows you to select from various setup functions and exit choices.

Warning: It is strongly recommended that you avoid making any changes to the chipset defaults.

These defaults have been carefully chosen by both AMI and your system manufacturer to provide the absolute maximum performance and reliability. Changing the defaults could make the system unstable and crash in some cases.

4.3 Main Settings



BIOS Setting	Description
System Language	Chooses the system default language.
System Date	Sets the date. Use the <Tab> key to switch between the data elements.
System Time	Set the time. Use the <Tab> key to switch between the data elements.

4.4 Advanced Settings

This section allows you to configure, improve your system and allows you to set up some system features according to your preference.

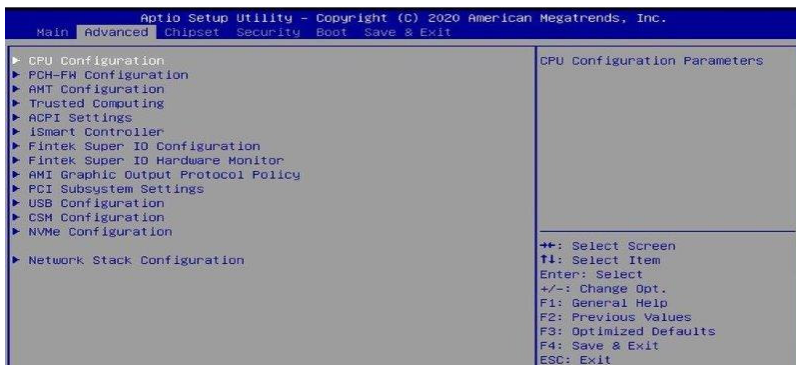

4.4.1 CPU Configuration



BIOS Setting	Description
Intel (VMX) Virtualization Technology	Enables / Disables a VMM to utilize the additional hardware capabilities provided by Vanderpool Technology.
Active Processor Cores	Number of cores to enable in each processor package. Options: All, 1, 2, 3
Hyper-Threading	Enabled for Windows XP and Linux (OS optimized for Hhyper-Threading Technology) and Disabled for other OS (OS not optimized for Hyper-Threading Technology).
Intel Trusted Execution Technology	Enables / Disables utilization of additional hardware capabilities provided by Intel(R) Trusted Execution Technology. Changes require a full power cycle to take effect.

4.4.2 PCH-FW Configuration

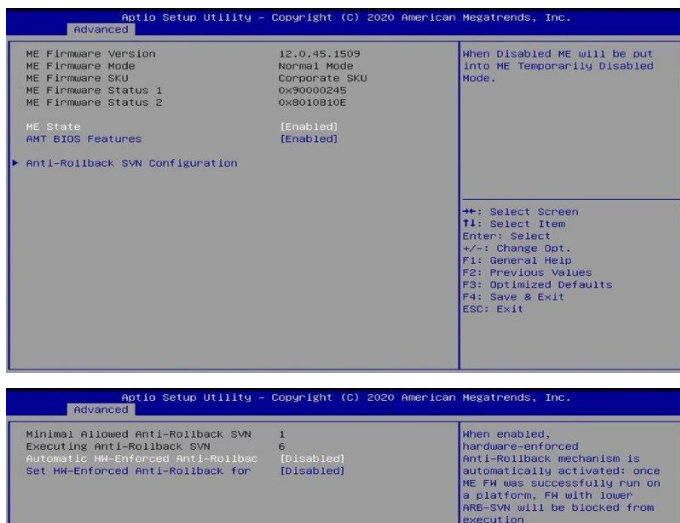

BIOS Setting	Description
ME State	When Disabled, ME will be put into ME Temporarily Disabled Mode.
AMT BIOS Features	When disabled, AMT BIOS Features are no longer supported and user is no longer able to access MEBx Setup. Note: This option does not disable Manageability Features in FW.
Anti-Rollback SVN Configuration	Configures Anti-Rollback SVN
Automatic HW-Enforced Anti-Rollback	When enable, hardware-enforced Anti-Rollback mechanism is automatically activated; once ME FW was successfully run on a platform, FW with lower ARB-VN will be blocked from execution.
Set HW-Enforced Anti-Rollback for Current SVN	Enable hardware-enforced Anti-Rollback mechanism for current ARB SVN value. FW with lower ARB-SVN will be blocked from execution. The value will be restored to disable after the command is sent.

4.4.3 AMT Configuration(For MI996VF series only)

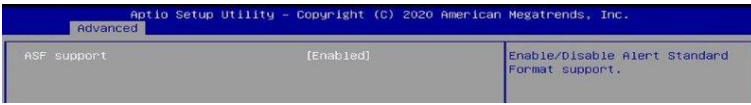

BIOS Setting	Description
ASF Support	Enable / Disable Alert Standard Format support.

4.4.4 Trusted Computing



BIOS Setting	Description
Security Device Support	Enables / Disables BIOS support for security device. O.S. will not show security device. TCG EFI protocol and INT1A interface will not be available.
Pending operation	Schedule an operation for the security device. Note: Your computer will reboot during restart in order to change state of security device.
TPM2.0 UEFI Spec Version	Select the TCG2 Spec Version Support. TCG_1_2: the compatible mode for Win8/Win10. TCG_2: Support new TCG2 protocol and event format for Win10 or later.
Physical Presence Spec Version	Select to tell O.S. to support PPI Spec Version 1.2 or 1.3. Note: some HCK tests might not support 1.3.
Device Select	TPM 1.2 will restrict support to TPM 1.2 devices. TPM 2.0 will restrict support to TPM 2.0 devices. Auto will support both with the default set to TPM 2.0 devices. If not found, TPM 1.2 devices will be enumerated.

4.4.5 ACPI Settings



BIOS Setting	Description
Enable Hibernation	Enables / Disables the system ability to hibernate (OS/S4 Sleep State). This option may be not effective with some OS.
ACPI Sleep State	Selects an ACPI sleep state where the system will enter when the Suspend button is pressed.

4.4.6 iSmart Controller



BIOS Setting	Description
Power-On after Power failure	Enables / Disables the system to be turned on automatically after a power failure.
Temperature Guardian	Generate the reset signal when system hands up on POST.
Schedule Slots	<p>Sets up the hour / minute / day for the power-on schedule for the system.</p> <p>Options are None, Power On, and Power On / Off.</p> <p>Important: If you would like to set up a schedule between adjacent days, configure two schedule slots.</p> <p>For example, if setting up a schedule from Wednesday 5 p.m. to Thursday 2 a.m., configure two schedule slots. But if setting up a schedule from 3 p.m to 5 p.m. on Wednesday, configure only a schedule slot.</p>

4.4.7 Fintek Super IO Configuration

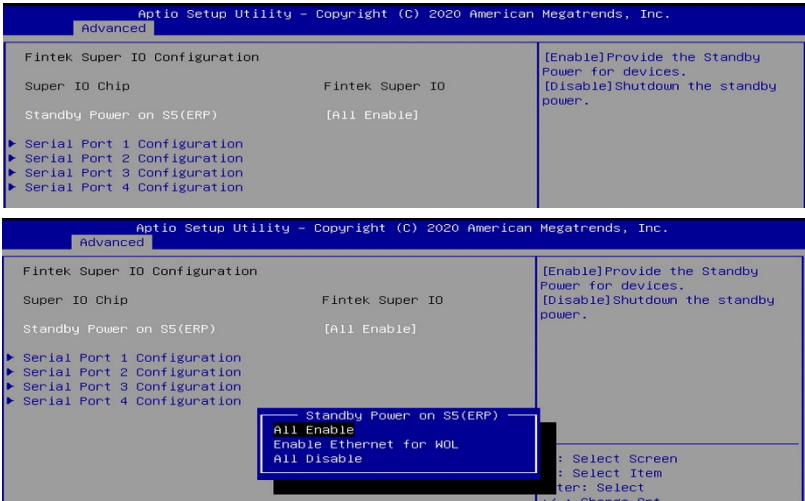

BIOS Setting	Description
Standby Power on S5 (ERP) – for MI996EF only	Enables / Disables to provide the standby power for devices. Options: All Enable / Enable Ethernet for WOL / All Disable
Serial Port Configuration	Sets parameters of Serial Ports. Enables / Disables the serial port and select an optimal setting for the Super IO device.

4.4.7.1. Serial Port 1~4 Configuration

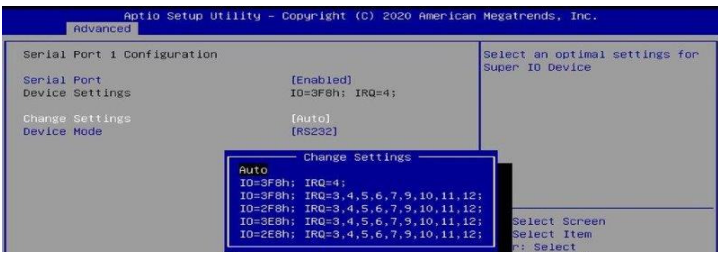

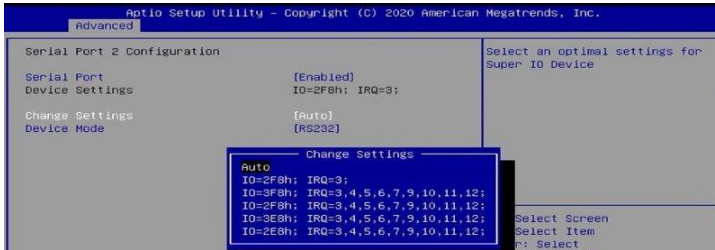

4.4.8 Fintek Super IO Hardware Monitor

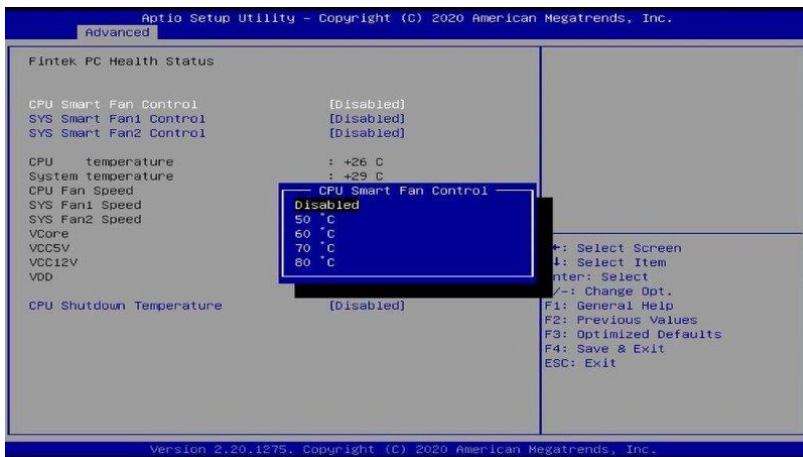

BIOS Setting	Description
CPU Smart Fan Control	Enables / Disables the CPU smart fan feature.
System Smart Fan Control	Enables / Disables the system smart fan feature.
Temperatures / Voltages	These fields are the parameters of the hardware monitoring function feature of the motherboard. The values are read-only values as monitored by the system and show the PC health status.
CPU Shutdown Temperature	Enables / Disables the CPU shutdown temperature function.

4.4.9 AMI Graphic Output Protocol Policy

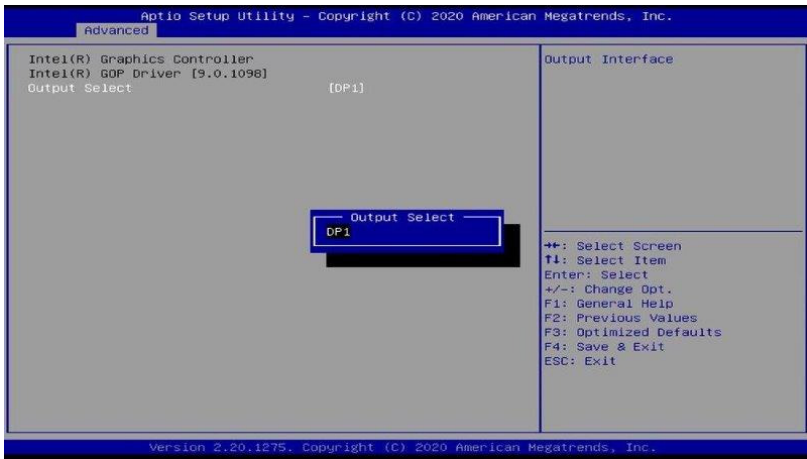

4.4.10 PCI Subsystem Settings



4.4.11 USB Configuration



BIOS Setting	Description
Legacy USB Support	<p>Enables Legacy USB support.</p> <ul style="list-style-type: none"> • Auto disables legacy support if there is no USB device connected. • Disable keeps USB devices available only for EFI applications.
XHCI Hand-off	This is a workaround for OSeS without XHCI hand-off support. The XHCI ownership change should be claimed by XHCI driver.
USB Mass Storage Driver Support	Enables / Disables the support for USB mass storage driver.
USB Transfer time-out	<p>The time-out value for control, bulk, and Interrupt transfers.</p> <p>Options: 1 sec / 5 sec / 10 sec / 20 sec</p>
Device reset time-out	<p>Seconds of delaying execution of start unit command to USB mass storage device.</p> <p>Options: 10 sec / 20 sec / 30 sec / 40 sec</p>
Device power-up delay	<p>The maximum time the device will take before it properly reports itself to the Host Controller.</p> <p>Auto uses default value for a Root port it is 100ms. But for a Hub port, the delay is taken from Hub descriptor.</p> <p>Options: Auto / Manual</p>

4.4.12 CSM Configuration



BIOS Setting	Description
CSM Support	Enables / Disables CSM support.
GateA20 Active	<ul style="list-style-type: none"> • Upon Request disables GA20 when using BIOS services. • Always cannot disable GA20, but is useful when any RT code is executed above 1 MB.
INT19 Trap Response	<p>Sets how BIOS reacts on INT19 trap by Option ROM.</p> <ul style="list-style-type: none"> • Immediate executes the trap right away. • Postponed executes the trap during legacy boot.
Boot option filter	<p>Controls the priority of Legacy and UEFI ROMs.</p> <p>Options: UEFI and Legacy / Legacy only / UEFI only</p>
Network	<p>Controls the execution of UEFI and Legacy PXE OpROM.</p> <p>Options: Do not launch / UEFI/Legacy</p>

4.4.13 NVMe Configuration



4.4.14 Network Stack



4.5 Chipset Settings



BIOS Setting	Description
System Agent (SA) Configuration	System Agent (SA) parameters
PCH-IO Configuration	PCH parameters

4.5.1 System Agent (SA) Configuration



BIOS Setting	Description
Memory Configuration	Memory configuration parameters.
Graphics Configuration	Configures the graphics settings.
VT-d	Checks if VT-d function on MCH is supported.

4.5.1.1. Graphics Configuration

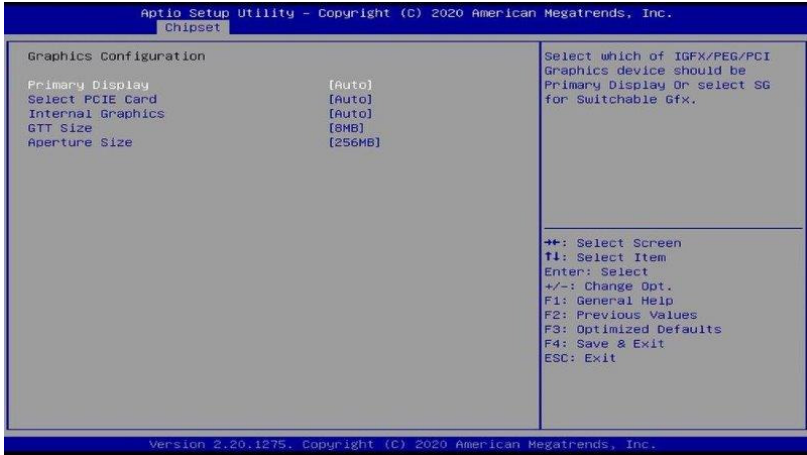

BIOS Setting	Description
Primary Display	Configures the external Gfx card primary display.
Select PCIE Card	Select the card used on the platform Auto: Skip GPIO based on Power Enable to dGPU Elk Creek 4: DGPU Power Enable = ActiveLow PEG Eval: DGPU Power Enable = ActiveHigh
Internal Graphics	Keep IGFX enabled based on the setup options. Options: Auto / Disabled / Enabled
GTT Size	Sets the GTT size as 2 MB, 4 MB, or 8 MB.
Aperture Size	Sets the aperture size as 128 MB / 256 MB / 512 MB / 1024 MB / 2048 MB. Note: Above 4 GB MMIO BIOS assignment is automatically enabled when selecting 2048 MB aperture. To use this feature, disable CSM support.

4.5.2 PCH-IO Configuration



BIOS Setting	Description
SATA and RST Configuration	Configures SATA devices.
PCH LAN Controller	Enables / Disables the onboard NIC.
Wake on LAN Enable	Enables / Disables the integrated LAN to wake up the system.

4.5.2.1. SATA and RST Configuration:



BIOS Setting	Description
SATA Controller(s)	Enables / Disables the SATA device.
SATA Mode Selection	Determines how SATA controller(s) operate. Options: AHCI / Intel RST Premium
Serial ATA Ports	Enables / Disables serial ports.
SATA Ports Hot Plug	Enables / Disables SATA Ports HotPlug.

4.6 Security Settings

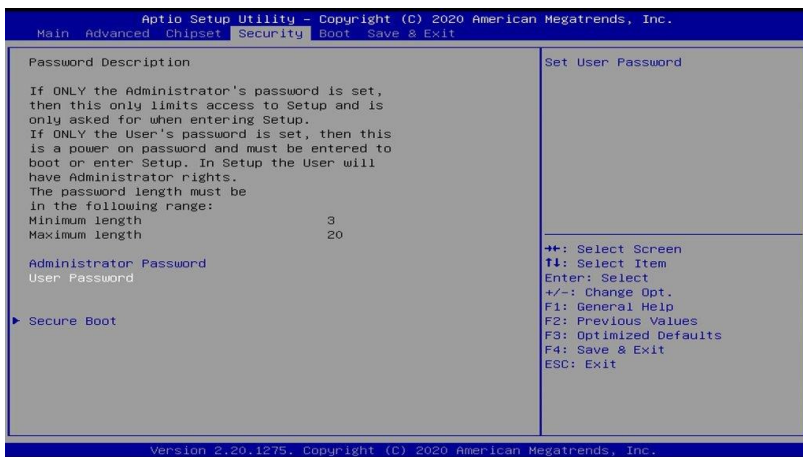

BIOS Setting	Description
Administrator Password	Sets an administrator password for the setup utility.
User Password	Sets a user password.

4.6.1 Secure Boot

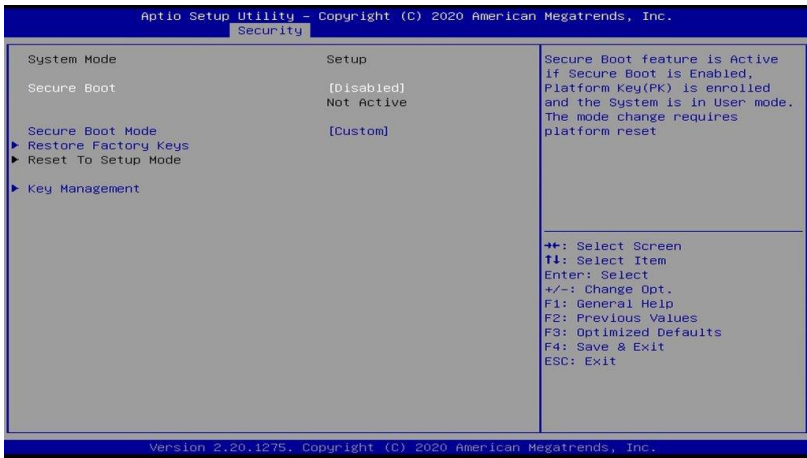

BIOS Setting	Description
Secure Boot	Enable this feature to activate Secure Boot. Platform Key (PK) is enrolled and the system is in User mode. The mode change requires platform reset.
Secure Boot Mode	Secure Boot mode options: Standard or Custom. In Custom mode, Secure Boot Policy variables can be configured by a physically present user without full authentication.
Restore Factory Keys	Force System to user mode. Install factory default Secure Boot Key databases.
Key Management	Enables expert users to modify Secure Boot Policy variables without full authentication.

4.6.1.1. Restore Factory Keys

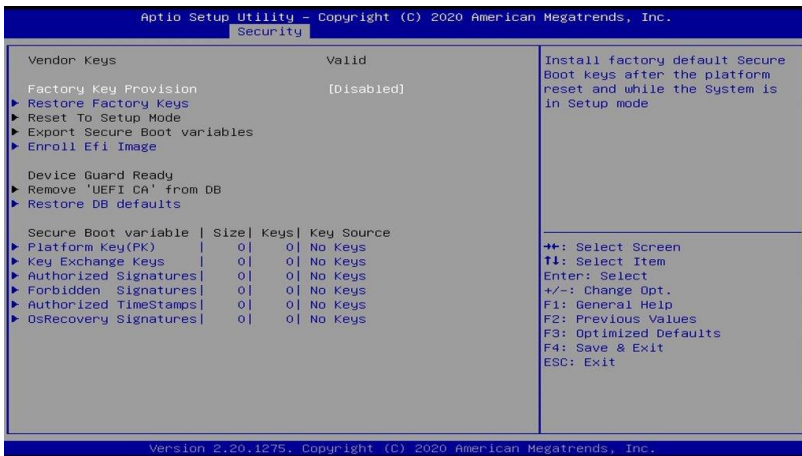

BIOS Setting	Description
Factory Key Provision	Install factory default secure boot keys after the platform reset and while the system is in setup mode.

4.7 Boot Settings

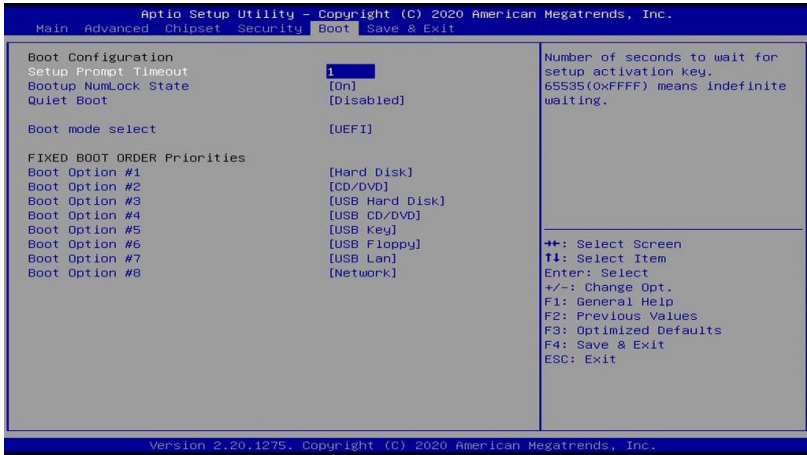

BIOS Setting	Description
Setup Prompt Timeout	Number of seconds to wait for setup activation key. 65535(0xFFFF) means indefinite waiting.
Bootup NumLock State	Selects the keyboard NumLock state.
Quiet Boot	Enables / Disables Quiet Boot option.
Boot mode select	Selects a Boot mode, Legacy / UEFI.
Boot Option Priorities	Sets the system boot order.

4.8 Save & Exit Settings

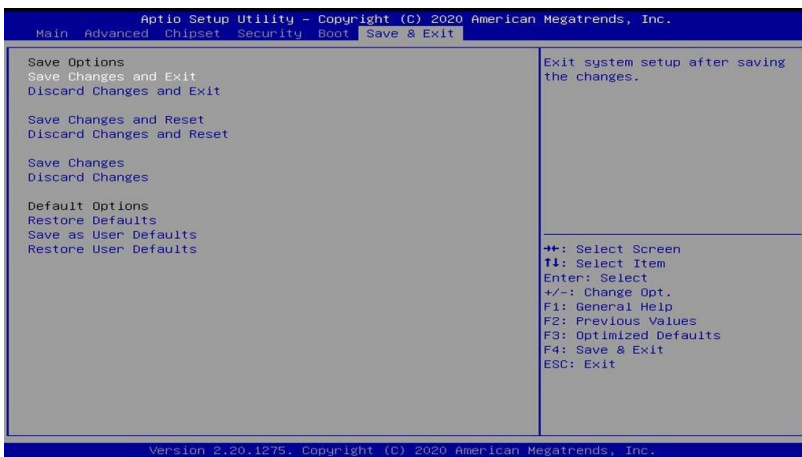

BIOS Setting	Description
Save Changes and Exit	Exits system setup after saving the changes.
Discard Changes and Exit	Exits system setup without saving any changes.
Save Changes and Reset	Resets the system after saving the changes.
Discard Changes and Reset	Resets system setup without saving any changes.
Save Changes	Saves changes done so far to any of the setup options.
Discard Changes	Discards changes done so far to any of the setup options.
Restore Defaults	Restores / Loads defaults values for all the setup options.
Save as User Defaults	Saves the changes done so far as User Defaults.
Restore User Defaults	Restores the user defaults to all the setup options.

This page is intentionally left blank.

Appendix

This section provides the mapping addresses of peripheral devices, the sample code of watchdog timer configuration, and types of on-board connectors.

A. I/O Port Address Map

Each peripheral device in the system is assigned a set of I/O port addresses which also becomes the identity of the device. The following table lists the I/O port addresses used.

Address	Device Description
0x00000A00-0x00000A0F	Motherboard resources
0x00000A10-0x00000A1F	Motherboard resources
0x00000A20-0x00000A2F	Motherboard resources
0x0000002E-0x0000002F	Motherboard resources
0x0000004E-0x0000004F	Motherboard resources
0x00000061-0x00000061	Motherboard resources
0x00000063-0x00000063	Motherboard resources
0x00000065-0x00000065	Motherboard resources
0x00000067-0x00000067	Motherboard resources
0x00000070-0x00000070	Motherboard resources
0x00000080-0x00000080	Motherboard resources
0x00000092-0x00000092	Motherboard resources
0x000000B2-0x000000B3	Motherboard resources
0x00000680-0x0000069F	Motherboard resources
0x0000164E-0x0000164F	Motherboard resources
0x00003000-0x0000301F	Ethernet Controller
0x00003000-0x0000301F	Intel(R) PCI Express Root Port #12 - A333
0x00004090-0x00004097	Standard SATA AHCI Controller
0x00004080-0x00004083	Standard SATA AHCI Controller
0x00004060-0x0000407F	Standard SATA AHCI Controller
0x00000020-0x00000021	Programmable interrupt controller
0x00000024-0x00000025	Programmable interrupt controller
0x00000028-0x00000029	Programmable interrupt controller
0x0000002C-0x0000002D	Programmable interrupt controller
0x00000030-0x00000031	Programmable interrupt controller

Address	Device Description
0x00000034-0x00000035	Programmable interrupt controller
0x00000038-0x00000039	Programmable interrupt controller
0x0000003C-0x0000003D	Programmable interrupt controller
0x000000A0-0x000000A1	Programmable interrupt controller
0x000000A4-0x000000A5	Programmable interrupt controller
0x000000A8-0x000000A9	Programmable interrupt controller
0x000000AC-0x000000AD	Programmable interrupt controller
0x000000B0-0x000000B1	Programmable interrupt controller
0x000000B4-0x000000B5	Programmable interrupt controller
0x000000B8-0x000000B9	Programmable interrupt controller
0x000000BC-0x000000BD	Programmable interrupt controller
0x000004D0-0x000004D1	Programmable interrupt controller
0x000003F8-0x000003FF	Communications Port (COM1)
0x000002F8-0x000002FF	Communications Port (COM2)
0x000003E8-0x000003EF	Communications Port (COM3)
0x000002E8-0x000002EF	Communications Port (COM4)
0x00001854-0x00001857	Motherboard resources
0x00001800-0x000018FE	Motherboard resources
0x00000000-0x00000CF7	PCI Express Root Complex
0x00000D00-0x0000FFFF	PCI Express Root Complex
0x0000FFF8-0x0000FFFF	Intel(R) Active Management Technology - SOL (COM5)
0x000000F0-0x000000F0	Numeric data processor
0x00002000-0x000020FE	Motherboard resources
0x00000060-0x00000060	Standard PS/2 Keyboard
0x00000064-0x00000064	Standard PS/2 Keyboard
0x00004000-0x0000403F	Intel(R) UHD Graphics 630
0x00000040-0x00000043	System timer
0x00000050-0x00000053	System timer
0x0000EFA0-0x0000EFBF	Intel(R) SMBus - A323

B. Interrupt Request Lines (IRQ)

Peripheral devices use interrupt request lines to notify CPU for the service required. The following table shows the IRQ used by the devices on board.

Level	Function
IRQ 0	System timer
IRQ 1	Standard PS/2 Keyboard
IRQ 3	Communications Port (COM2)
IRQ 4	Communications Port (COM1)
IRQ 5	Communications Port (COM3)
IRQ 10	Communications Port (COM4)
IRQ 11	Intel(R) SMBus - A323
IRQ 11	Ethernet Controller
IRQ 13	Numeric data processor
IRQ 14	Intel(R) Serial IO GPIO Host Controller - INT3450
IRQ 16	High Definition Audio Controller
IRQ 19	Intel(R) Active Management Technology - SOL (COM5)
IRQ 48	Trusted Platform Module 2.0
IRQ 54~204	Microsoft ACPI-Compliant System
IRQ 256~511	Microsoft ACPI-Compliant System
IRQ 4294967291	Intel(R) Ethernet Connection (7) I219-LM
IRQ 4294967288	Intel(R) Management Engine Interface
IRQ 4294967293	Intel(R) PCI Express Root Port #12 - A333
IRQ 4294967294	Intel(R) PCIe Controller (x16) - 1901
IRQ 4294967290	Intel(R) UHD Graphics 630
IRQ 4294967289	Intel(R) USB 3.1 eXtensible Host Controller - 1.10 (Microsoft)
IRQ 4294967292	Standard SATA AHCI Controller

C. Watchdog Timer Configuration

The Watchdog Timer (WDT) is used to generate a variety of output signals after a user programmable count. The WDT is suitable for use in the prevention of system lock-up, such as when software becomes trapped in a deadlock. Under these sorts of circumstances, the timer will count to zero and the selected outputs will be driven.

Under normal circumstance, you will need to restart the WDT at regular intervals before the timer counts to zero.

Sample Code:

```
//-----
//
// THIS CODE AND INFORMATION IS PROVIDED "AS IS" WITHOUT WARRANTY OF ANY
// KIND, EITHER EXPRESSED OR IMPLIED, INCLUDING BUT NOT LIMITED TO THE
// IMPLIED WARRANTIES OF MERCHANTABILITY AND/OR FITNESS FOR A PARTICULAR
// PURPOSE.
//
//-----
#include <dos.h>
#include <conio.h>
#include <stdio.h>
#include <stdlib.h>
#include "F81964.H"
//-----
int main (int argc, char *argv[]);
void EnableWDT(int);
void DisableWDT(void);
//-----
int main (int argc, char *argv[])
{
    unsigned char bBuf;
    unsigned char bTime;
    char **endptr;

    char SIO;

    printf("Fintek 81964 watch dog program\n");
    SIO = Init_F81964();
    if (SIO == 0)
    {
        printf("Can not detect Fintek 81964, program abort.\n");
        return(1);
    }
    //if (SIO == 0)

    if (argc != 2)
    {
        printf("Parameter incorrect!!\n");
        return (1);
    }
}
```

```

bTime = strtol (argv[1], endptr, 10);
printf("System will reset after %d seconds\n", bTime);

if (bTime)
{
    EnableWDT(bTime);
}
else
{
    DisableWDT();
    return 0;
}
}
//-----
void EnableWDT(int interval)
{
    unsigned char bBuf;

    bBuf = Get_F81964_Reg(0x2B);
    bBuf &= (~0x20);
    Set_F81964_Reg(0x2B, bBuf);           //Enable WDTO

    Set_F81964_LD(0x07);                 //switch to logic device 7
    Set_F81964_Reg(0x30, 0x01);         //enable timer

    bBuf = Get_F81964_Reg(0xF5);
    bBuf &= (~0x0F);
    bBuf |= 0x52;
    Set_F81964_Reg(0xF5, bBuf);         //count mode is second

    Set_F81964_Reg(0xF6, interval);     //set timer

    bBuf = Get_F81964_Reg(0xFA);
    bBuf |= 0x01;
    Set_F81964_Reg(0xFA, bBuf);         //enable WDTO output

    bBuf = Get_F81964_Reg(0xF5);
    bBuf |= 0x20;
    Set_F81964_Reg(0xF5, bBuf);         //start counting
}
//-----
void DisableWDT(void)
{
    unsigned char bBuf;

    Set_F81964_LD(0x07);                 //switch to logic device 7

    bBuf = Get_F81964_Reg(0xFA);
    bBuf &= ~0x01;
    Set_F81964_Reg(0xFA, bBuf);         //disable WDTO output

    bBuf = Get_F81964_Reg(0xF5);
    bBuf &= ~0x20;
    bBuf |= 0x40;
    Set_F81964_Reg(0xF5, bBuf);         //disable WDT
}
//-----

//-----
//
// THIS CODE AND INFORMATION IS PROVIDED "AS IS" WITHOUT WARRANTY OF ANY

```



```

// KIND, EITHER EXPRESSED OR IMPLIED, INCLUDING BUT NOT LIMITED TO THE
// IMPLIED WARRANTIES OF MERCHANTABILITY AND/OR FITNESS FOR A PARTICULAR
// PURPOSE.
//
//-----
#include "F81964.H"
#include <dos.h>
//-----
unsigned int F81964_BASE;
void Unlock_F81964 (void);
void Lock_F81964 (void);
//-----
unsigned int Init_F81964(void)
{
    unsigned int result;
    unsigned char ucDid;

    F81964_BASE = 0x4E;
    result = F81964_BASE;

    ucDid = Get_F81964_Reg(0x20);
    if (ucDid == 0x07)                //Fintek 81964
    {
        goto Init_Finish;
    }

    F81964_BASE = 0x2E;
    result = F81964_BASE;

    ucDid = Get_F81964_Reg(0x20);
    if (ucDid == 0x07)                //Fintek 81964
    {
        goto Init_Finish;
    }

    F81964_BASE = 0x00;
    result = F81964_BASE;

Init_Finish:
    return (result);
}
//-----
void Unlock_F81964 (void)
{
    outputb(F81964_INDEX_PORT, F81964_UNLOCK);
    outputb(F81964_INDEX_PORT, F81964_UNLOCK);
}
//-----
void Lock_F81964 (void)
{
    outputb(F81964_INDEX_PORT, F81964_LOCK);
}
//-----
void Set_F81964_LD( unsigned char LD)
{
    Unlock_F81964();
    outputb(F81964_INDEX_PORT, F81964_REG_LD);
    outputb(F81964_DATA_PORT, LD);
    Lock_F81964();
}
//-----

```

```
void Set_F81964_Reg( unsigned char REG, unsigned char DATA)
```

```
{
    Unlock_F81964();
    outportb(F81964_INDEX_PORT, REG);
    outportb(F81964_DATA_PORT, DATA);
    Lock_F81964();
}
//-----
unsigned char Get_F81964_Reg(unsigned char REG)
{
    unsigned char Result;
    Unlock_F81964();
    outportb(F81964_INDEX_PORT, REG);
    Result = inportb(F81964_DATA_PORT);
    Lock_F81964();
    return Result;
}
//-----

//-----
//
// THIS CODE AND INFORMATION IS PROVIDED "AS IS" WITHOUT WARRANTY OF ANY
// KIND, EITHER EXPRESSED OR IMPLIED, INCLUDING BUT NOT LIMITED TO THE
// IMPLIED WARRANTIES OF MERCHANTABILITY AND/OR FITNESS FOR A PARTICULAR
// PURPOSE.
//
//-----
#ifndef F81964_H
#define F81964_H                1
//-----
#define F81964_INDEX_PORT      (F81964_BASE)
#define F81964_DATA_PORT      (F81964_BASE+1)
//-----
#define F81964_REG_LD          0x07
//-----
#define F81964_UNLOCK          0x87
#define F81964_LOCK            0xAA
//-----
unsigned int Init_F81964(void);
void Set_F81964_LD( unsigned char);
void Set_F81964_Reg( unsigned char,
unsigned char); unsigned char
Get_F81964_Reg( unsigned char);
//-----
#endif // F81964_H
```

D. Onboard Connector Types

Function	Connector Name	Onboard Type	Compatible Mating Type for Reference
COM3 & COM4 RS-232 Ports	J2 (COM3), J3 (COM4)	Hao Guo Xing Ye DF11-10S-PA66H	HRS DF11-10DS-2C
eDP Connector	CN11	KEL SSL00-40S	KEL SSL20-40S
Digital I/O Connector	J1	Dupont 2.0 2*5 pin (Male)	Dupont 2.0 2*5 pin (Female)
Dual USB 2.0 Connector	J13, J15	Hao Guo Xing Ye DF11-8S-PA66H	Hirose DF11-8DS-2C
Front Panel Audio Connector	J16	Dupont 2.54 2*5 pin (Male)	Dupont 2.54 2*5 pin (Female)
Front Panel Settings Connector	J18	Dupont 2.54 2*4 pin (Male)	Dupont 2.54 2*4 pin (Female)
RTC Battery Connector	J17	TechBest 252-WS2-02-LF	Molex 51021-0200
eDP Panel Power Selection	JP3	Dupont 2.0 3 pin (Male)	Dupont 2.0 3 pin (Female)
Clearing CMOS Data	JP6	Dupont 2.0 3 pin (Male)	Dupont 2.0 3 pin (Female)
Clearing ME Register	JP7	Dupont 2.0 3 pin (Male)	Dupont 2.0 3 pin (Female)
PCIe Bifurcation Selection	JP8, JP9	Dupont 2.0 2 pin (Male)	Dupont 2.0 2 pin (Female)